

ORDINANCE NO. 17-97

AN ORDINANCE ADOPTING THE SOUTH NEVADA
URBAN RENEWAL AREA STREETScape STANDARDS

WHEREAS, the City Council created the South Nevada Urban Renewal Area (the "URA") and approved its associated urban renewal plan on November 24, 2015; and

WHEREAS, the adoption of streetscape standards within the URA will assist in the elimination of blight and promote economic development and investment opportunities; and

WHEREAS, streetscape standards increase the coordination and predictability of streetscape design, establish a high level of design quality, and ensure adequate mobility options; and

WHEREAS, the adoption of streetscape standards ensures the streetscape environment within the URA is attractive and links the public street corridors together through a coordinated neighborhood-wide approach; and

WHEREAS, the Colorado Springs Urban Renewal Authority Board and the City Planning Commission recommend approval of these streetscape standards.

NOW, THEREFORE, BE IT ORDAINED BY THE CITY COUNCIL OF THE CITY OF COLORADO SPRINGS:

Section 1. The South Nevada Urban Renewal Area Streetscape Standards, attached as Exhibit A, are hereby adopted and empowered pursuant to the Zoning Ordinance of the City of Colorado Springs.

Section 2. This ordinance shall be in full force and effect from and after its final adoption and publication as provided by Charter.

Section 3. Council deems it appropriate that this ordinance be published by title and summary prepared by the City Clerk and that this

ordinance be available for inspection and acquisition in the office of the City Clerk.

Introduced, read, passed on first reading and ordered published this 10th day of October, 2017.

Finally passed: October 24th 2017



Council President

Mayor's Action:

- Approved on October 26, 2017.
- Disapproved on _____, based on the following objections:



Mayor

Council Action After Disapproval:

- Council did not act to override the Mayor's veto.
- Finally adopted on a vote of _____, on _____.
- Council action on _____ failed to override the Mayor's veto.

Council President

ATTEST:





Sarah B. Johnson, City Clerk



I HEREBY CERTIFY, that the foregoing ordinance entitled “AN ORDINANCE ADOPTING THE SOUTH NEVADA URBAN RENEWAL AREA STREETScape STANDARDS” was introduced and read at a regular meeting of the City Council of the City of Colorado Springs, held on October 10th, 2017; that said ordinance was finally passed at a regular meeting of the City Council of said City, held on the 24th day of October, 2017, and that the same was published by title and summary, in accordance with Section 3-80 of Article III of the Charter, in the Transcript, a newspaper published and in general circulation in said City, at least ten days before its passage.

IN WITNESS WHEREOF, I have hereunto set my hand and affixed the seal of the City, this 26th day of October, 2017.

Sarah B. Johnson, City Clerk



1st Publication Date: October 13th, 2017
2nd Publication Date: November 1st, 2017

Effective Date: November 6th, 2017

Initial: SBJ
City Clerk

South Nevada Urban Renewal District Streetscape Design Standards

April 25, 2017

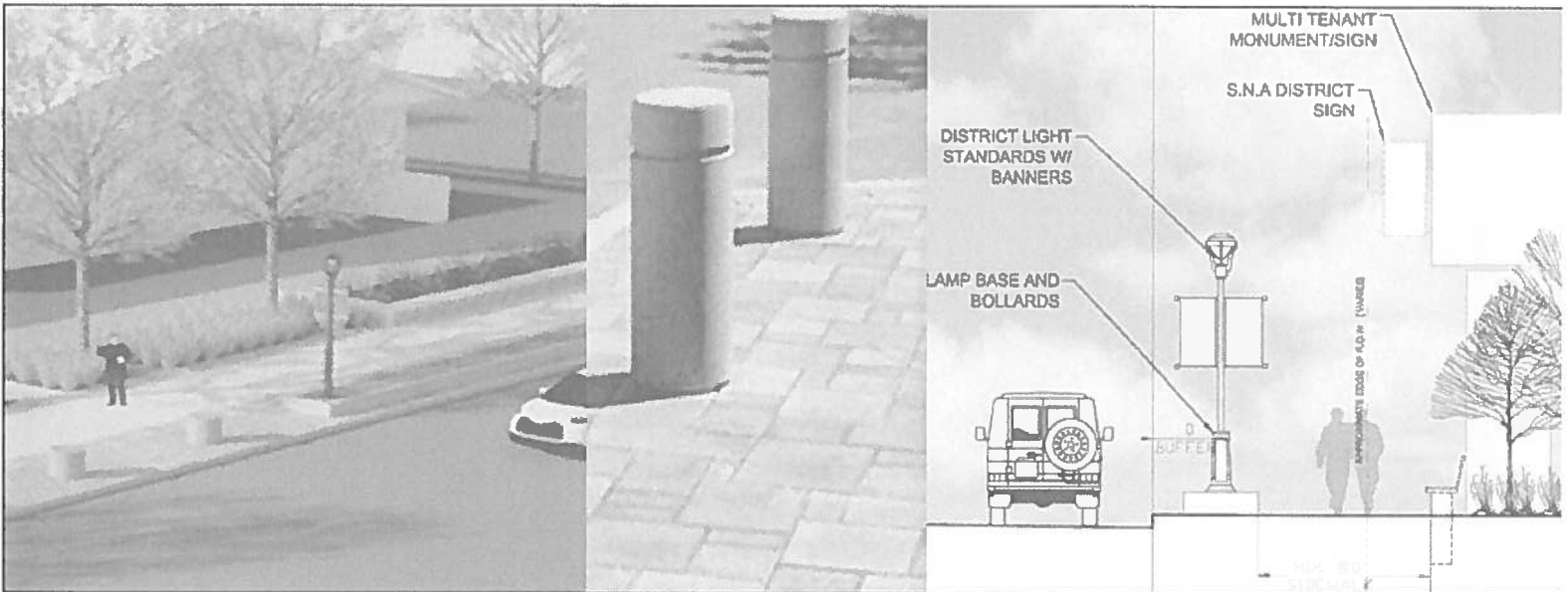

THOMAS THOMAS

FIGURE 1

South Nevada Urban Renewal District Streetscape Design Standards

Acknowledgments

Colorado Springs Urban Renewal Authority Board

Merv Bennet
Randy Case
Tiffany Colvert, Vice Chair
Gary Feffer
Toby Gannett
Valerie Hunter
Maureen Juran
Jim Mason
Brain Olson
Wynne Palermo, Chair
Jarred Rego
Peter Scoville

CSURA Staff

Jariah Walker, Executive Director
David Neville, Legal Counsel
Carrie Bartow, CPA
Dean Beukema, Administrative Staff

City Planning

Peter Wysocki
Ryan Tefertiller
Matthew Fitzsimmons
Connie Perry

Planning Team

Equity Group
RTA Architects
Thomas & Thomas Planning Urban Design and Landscape Architecture, Inc

Stakeholder Groups

Ivy Wild Development LLC
EVC-HD South Nevada, LLC

South Nevada Urban Renewal District Streetscape Design Standards

A. Introduction:

The following Streetscape Standards are organized to meet the design intent associated with the identified right-of-way sections of South Nevada Ave., Cheyenne Road and related side streets within the South Nevada Urban Renewal District (SNURD) area. The standards do not include the redevelopment of South Tejon Street and they do not reflect the design intent of the internal development areas, but specific to the streetscape portions of the District. The standards provide the basic site elements and details (regarding paving, lighting, landscaping, site furnishings median and selective project monument signage) for the noted streets.



South Nevada Urban Renewal District Streetscape Design Standards

The provisions of the South Nevada Urban Renewal District (SNURD) Streetscape Design Standards shall apply hand-in-hand with the City's Zoning and Development Code in all cases where the right-of-way is:

- a. Being modified or improved
- b. Being changed by the property owner or developer
- c. Being reviewed associated with proposed Development Plan approval
- d. Being redesigned associated with major utility improvements

Design Intent:

The SNURD streetscape is intended to provide cohesive and consistent design standards for the South Nevada Ave corridor from Interstate-25 south to Cheyenne Road and west on Cheyenne Road to Cascade Ave. The standards will also provide the general guidance for the associated side streets of E. St Elmo, E. Ramona, E. Navajo, E Brookside, E Arvada and Motor-Way Streets.

Recognizing the slow and phased nature of the redevelopment corridor and district, the standards seek to provide a basic foundation of materials and features that will be introduced over time to complete the full vision of the streetscape. Overall the standards address the full width of the right-of-way, including the median. The streetscape design objectives are:

- To provide a safe and inviting corridor for bike and pedestrian users
- To calm traffic to further encourage pedestrian and cycling use
- To establish a high quality public improvement and landscape environment within the corridor
- To introduce and encourage the development of common architectural elements in the public improvement zones adjacent to the right-of-way
- To support and encourage public and private investment
- To seek balance for constructability, maintenance and marketability
- To provide a predictable and sustainable environment

The following elements, materials and furnishings have been identified as part of the streetscape improvements envisioned for the two public improvement corridors, relate existing right-of-ways and identified public improvement zones.

Overall the proposed streetscape improvements are built from the existing curb lines. The right-of ways consist primarily of hardscape enhancements and underground utilities, with large walks transitioning to the public landscape improvement zone or setback. The public landscape improvement zone will provide for some utility switches and equipment vaults, but will consist primarily of the new seatwalls, plantings and free-standing signs as conceptually illustrated below.

South Nevada Urban Renewal District Streetscape Design Standards

B. Related to Application and Approval

These Design Guidelines build upon the vision and goals identified within the 2016 South Nevada Area Corridor Urban Renewal Plan. The Design Guidelines are considered an advisory document to be used by the Colorado Springs Urban Renewal Authority (CSURA) and the City Planning Development Review office. Design Guidelines will only be required to conform to the Design Guidelines if and when the property is redeveloped and requires a zone change, plat, concept plan and/or development plan submittal as required by the City of Colorado Springs City Code.

City of Colorado Springs/Regional Building Department Review and Approval Requirements:

The City of Colorado Springs has adopted certain zoning ordinances, land use codes and subdivision ordinances which include use restrictions, specific requirements and various performance standards, and the Pikes Peak Regional Building Department has similarly adopted certain building codes and construction standards, methods and requirements, all of which are collectively referred to herein as the "City Land Use and Building Requirements." The standards, requirements and prohibitions contained in these Design Guidelines are in addition to, and do not supersede, the other City Land Use and Building Requirements, which City Land Use and Building Requirements must be separately complied with. To the extent that any of the provisions of these Design Guidelines are in direct conflict with the other City Land Use and Building Requirements, the more restrictive provisions shall control, with the express understanding that these Design Guidelines may be more restrictive than the City Land Use and Building Requirements, but may not be less restrictive.

Colorado Springs Urban Renewal Authority's Review and Approval Requirement:

All projects proposed within the boundaries of the URA shall also be submitted to the Colorado Springs Urban Renewal Authority (CSURA) to verify compliance with the Urban Renewal Plan and these Design Guidelines. The CSURA review and approval process is a separate but integral part of the City of Colorado Springs' development review process. CSURA will review an applicant's proposed plat, development plan, landscaping plan, zoning application and construction drawings (including, but not limited to, plans for all buildings, structures, fencing, signage, lighting, landscaping and uses, and collectively, the "Applicant Submittal Documents"). CSURA's review and determination of approval or disapproval may be done by CSURA administrative staff or by the CSURA Board (as determined by CSURA). CSURA may further require the applicant to present its Applicant Submittal Documents at a CSURA Board meeting. CSURA's approval, rejection, or comments upon any or all of the Applicant Submittal Documents, including any required revisions, modifications or amendments thereto required by CSURA, will be set forth in writing and distributed to the applicant, as well as to the City's Land Use Review Division. CSURA may exercise reasonable discretion in determining whether the Applicant

South Nevada Urban Renewal District Streetscape Design Standards

Submittal Documents meet the goals, objectives, vision and standards set forth in the Urban Renewal Plan and these Design Guidelines. CSURA's approval does not imply that the Applicant Submittal Documents comport with any other requirements, codes, restrictions or regulations, including but not limited to the other City Land Use and Building Requirements. CSURA does not have the authority to waive or otherwise alter or amend any of the other City Land Use and Building Requirements, all of which must be separately met by any applicant.

Streetscape Ownership:

All streetscape elements, including paving, tree grates, planters, seat walls, landscaping and all similar site features within the right-of-way shall be installed by the developer and shall become City of Colorado Springs property upon completion of the project and subject to the provisions of the CSURA development agreement.

Streetscape Maintenance:

Maintenance of the streetscape elements shall be at the sole responsibility of the adjacent property owner or it's identified business improvement district. The City of Colorado Springs Code Enforcement will provide oversight for the level of care and maintenance of the improvement areas. The maintenance responsibilities will include trash removal, irrigation repair/maintenance, landscape care and replacement, damaged hardscape and lighting repair.



Streetscape implementation along existing business frontage

South Nevada Urban Renewal District Streetscape Design Standards

C. Sidewalk Design

It is the intent to provide wide and continuous pedestrian pathways along both sides of South Nevada, the north side of Cheyenne Road and the adjacent side streets of E. St Elmo, E., Ramona, E. Navajo, E Brookside, E Arvada and Motor-Way Streets within the district.

The sidewalk design can influence the user experience and help define the character of the traffic corridor. The standards recognize the function of the sidewalk within the planned streetscape. The objective is to provide a safe and balanced space for the users and provide a connection to the adjacent uses and landscape. Each sidewalk zone may vary and the order of priorities may change to meet the local phasing and type of redevelopment. It is also recognized that in some cases redevelopment may not happen for many years and that in some situations full design intent will not be fully implemented or may go through an evolution as sites may receive upgrades before they are totally redeveloped. In all cases the design standards are provided to help assure a thoughtful and consistent streetscape through the phasing and build out of the district.

The following sections illustrate a typical cross section for the three streetscape zones of east and west South Nevada and north side of Cheyenne Road.

The sidewalk standards provide for: (See the following sections)

Street	Width	Comments
South Nevada (west side)	*10'	Attached w/ Raised Curb
South Nevada (east side)	8'	Attached w/ Raised Curb
Cheyenne Rd. (north side)	8'	Attached w/ Raised Curb
Side Streets	Per City Standards	Both sides of R.O.W.

*The west side of South Nevada Ave. is intended to be a multi-use path for bikes and pedestrians as directed by City Traffic in the goal of providing "Complete Streets"

The following pavement types have been identified as the basic colors and textures for the streetscape improvements. Each of the following sections and plans illustrate the general approved standards. Variations to the base materials will be subject to review and approval by the City.

South Nevada Urban Renewal District Streetscape Design Standards

TYPICAL SIDEWALK MATERIALS (final spec TBD with sample testing)

- A- Cast-in-place Concrete, Standard Gray, Scored 18" o.c.
- B- Cast-in-place Standard Gray Concrete, Scored 9'o.c.
- C- Cast-in-Place Stamped Concrete
 - i. Stamp: Bominte, Classic 4" x4" Granite Cobblestones
 - ii. Color: Solomon, 385 Lava SRI 23 (Dark Gray)
- D- Cast-in-place Stamped Cobble
 - i. Stamp: Stamp: Bominte, Broomfeild Cobblestones
 - ii. Color: Solomon, 750 Desert Tan SRI 45

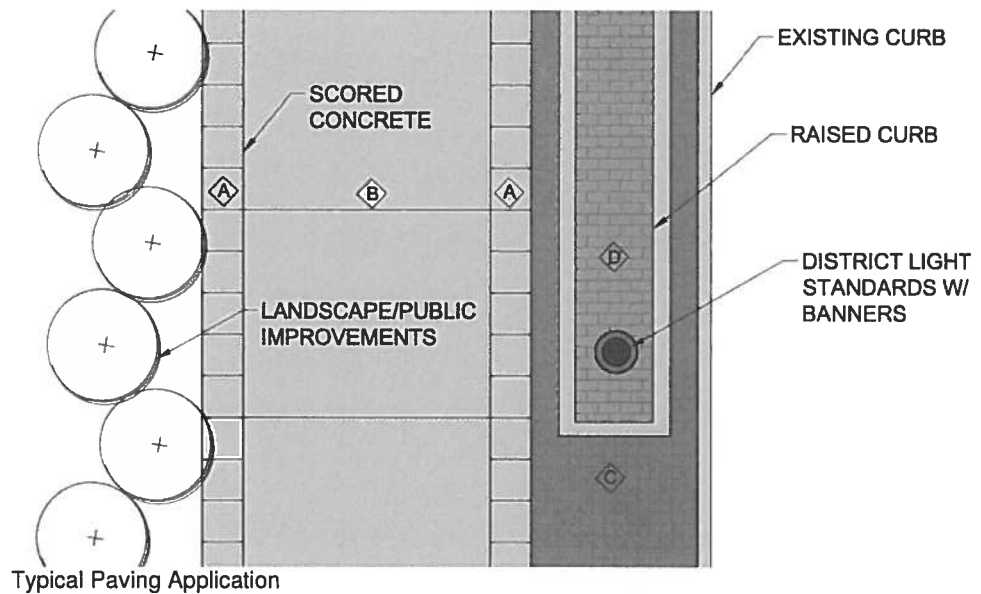

D. STREET SECTIONS:

The following sections and street right-of-way plans illustrate the typical design intent for the defined street corridors. Again the standards are intended to provide the basic framework for the streetscape sections and it is understood that much of the proposed improvements will not be implemented until major private or public renovations/projects are completed within the right-of-way. It is also understood that the full application of the design sections will be dependent upon various site conditions and constraints. Each section will be evaluated on a case by case basis through the development plan process and/or CSURA reviews.

One major planned utility improvement includes the west side of South Nevada Ave. The improvements plans will underground the existing large electrical lines. CSU has defined the proposed electrical conduit as a 36" wide concrete conduit under the proposed sidewalk. The work and final location with each site shall be coordinated and reviewed by Colorado Springs Utilities (CSU). It is agreed that the electrical conduit will be location approximately 17' on-center from back of existing curb. It is also understood that site conditions may still vary and these requirements may need to vary slightly to accommodate site conditions and surface improvement.

South Nevada Urban Renewal District Streetscape Design Standards

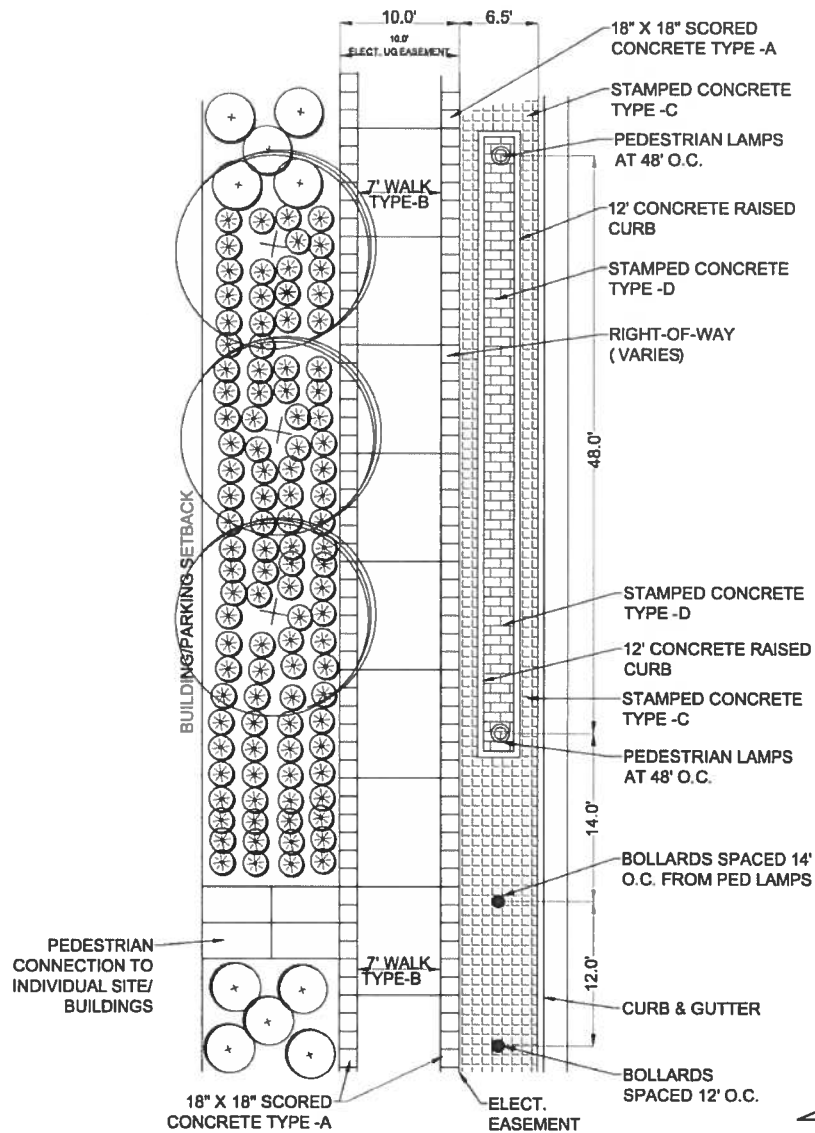
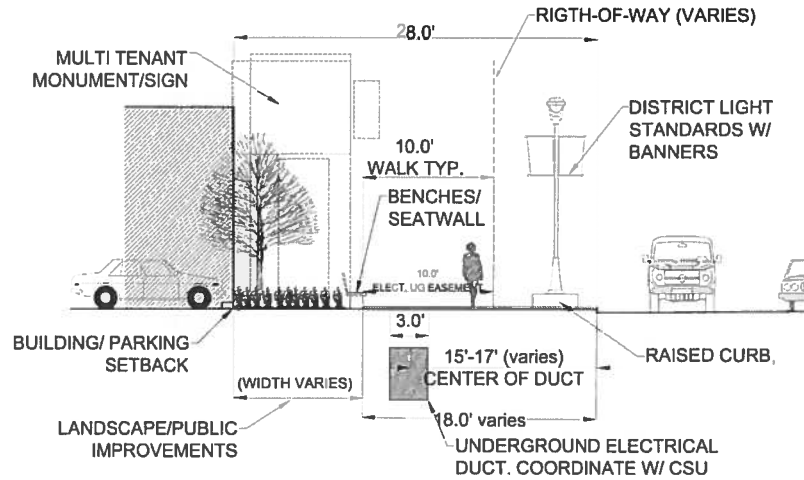

South Nevada Ave. West Section and Plan



South Nevada Urban Renewal District Streetscape Design Standards

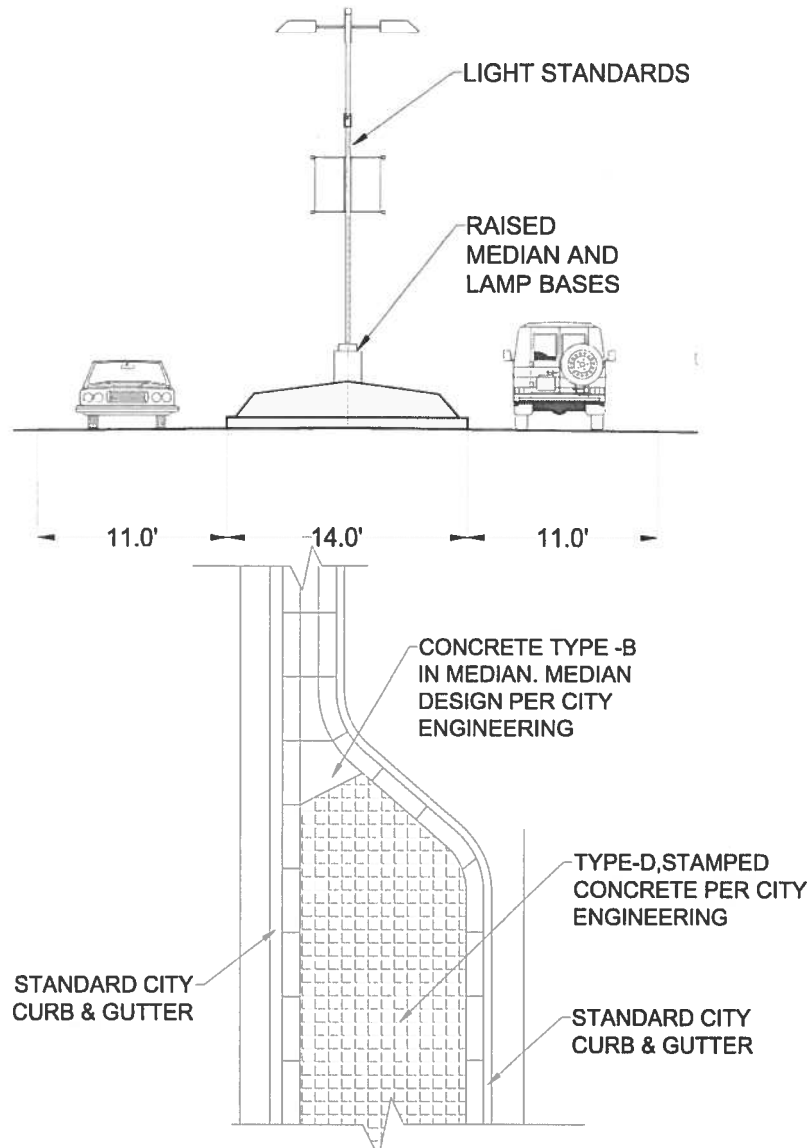

South Nevada Ave. Median Section and Plan

The medians will be finished to match the streetscape materials and colors as new sections are installed. Note the typical stamped and color descriptions above.

See Proposed Signalizations plan in the appendix (Exhibit A). In the case of intersection changes associated with proposed development, the medians will be designed and modified at the developer's expense. The resulting modifications will be built to the City Engineering and SNURD standards. If modifications are made by CDOT or the City, the SNURD standards shall be encouraged. It is understood that the City has agreed to replace all of the light fixtures in the median, at the City's expense at time of modifications.

South Nevada Urban Renewal District Streetscape Design Standards

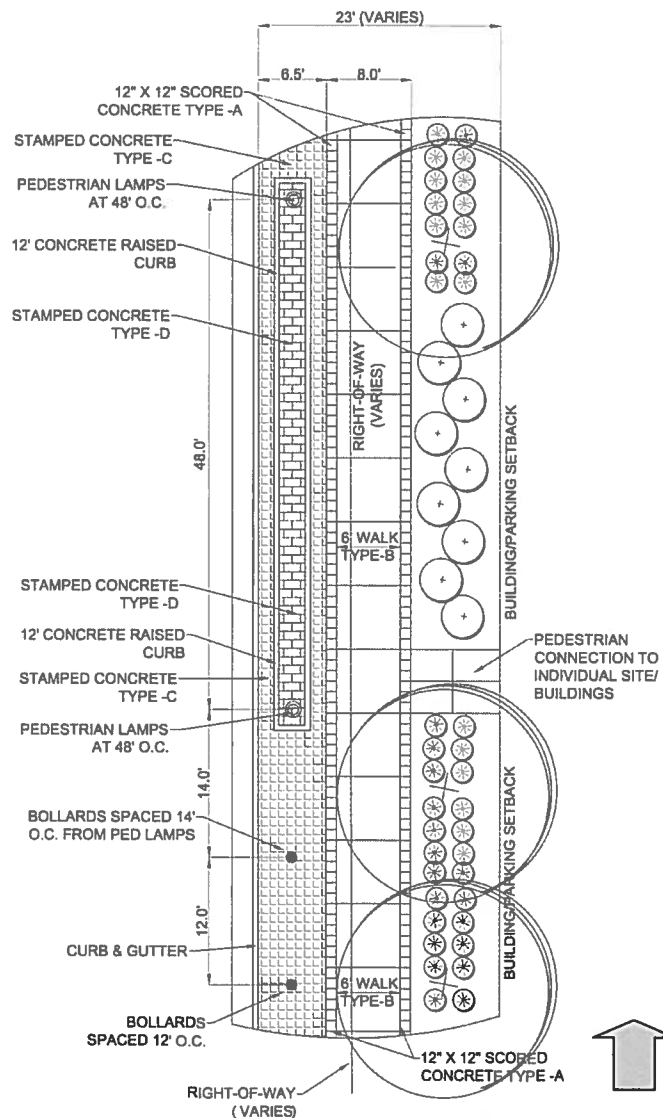
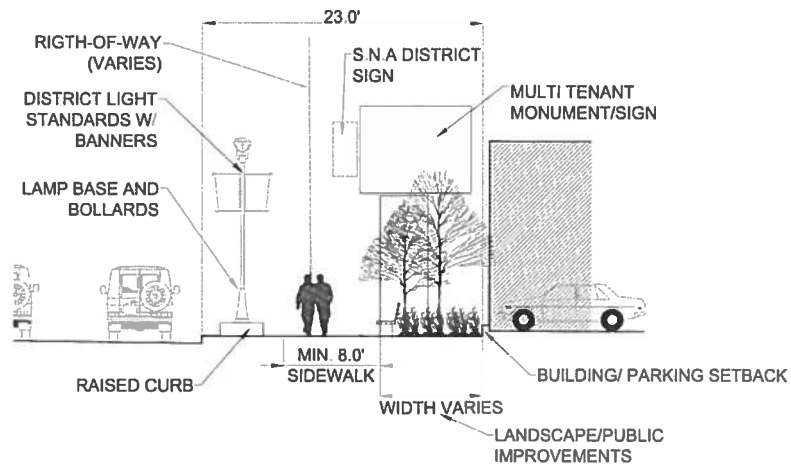

South Nevada Ave. East Side Section and Plan

South Nevada Urban Renewal District Streetscape Design Standards

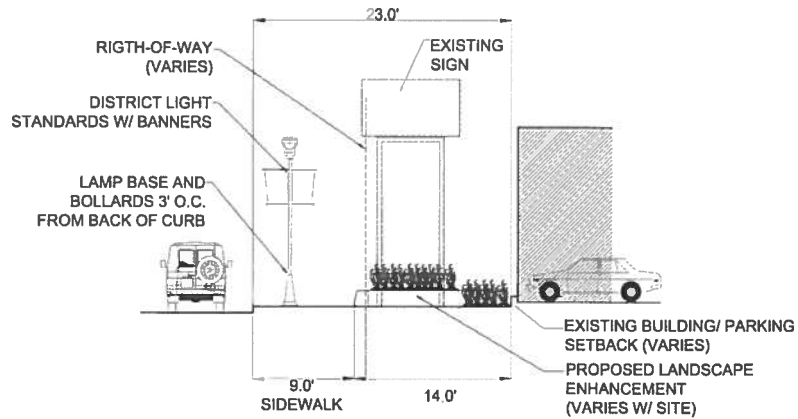

NEVADA AVE. SECTION VIEW (EXISTING CONDITIONS)

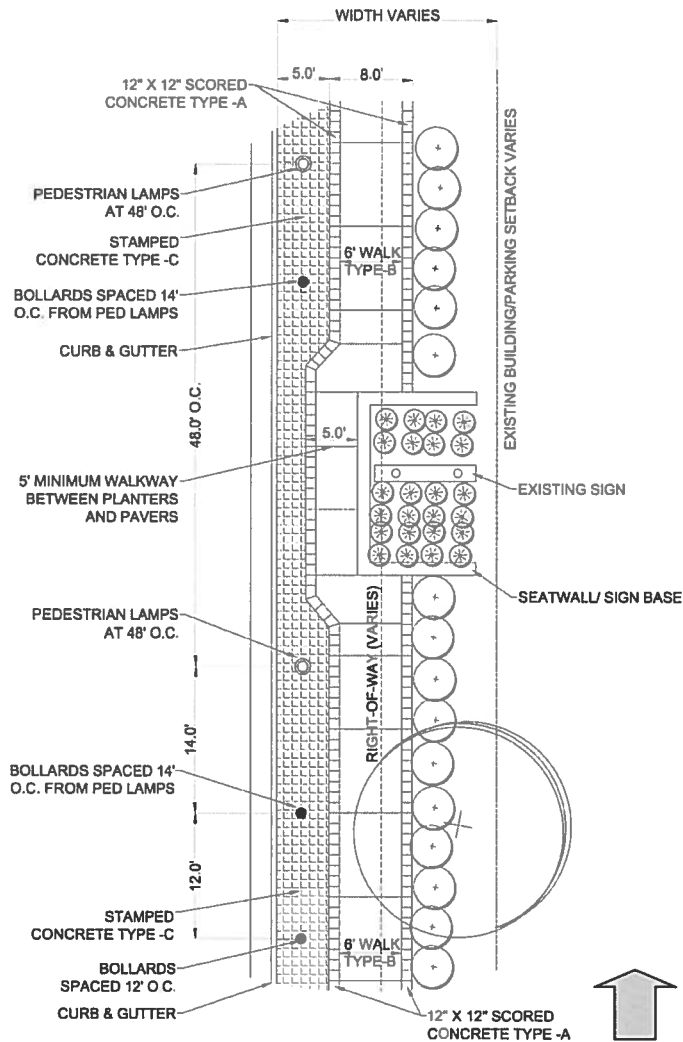

South Nevada East Side/ Existing Conditions Section and Plan Alternative

South Nevada Urban Renewal District Streetscape Design Standards

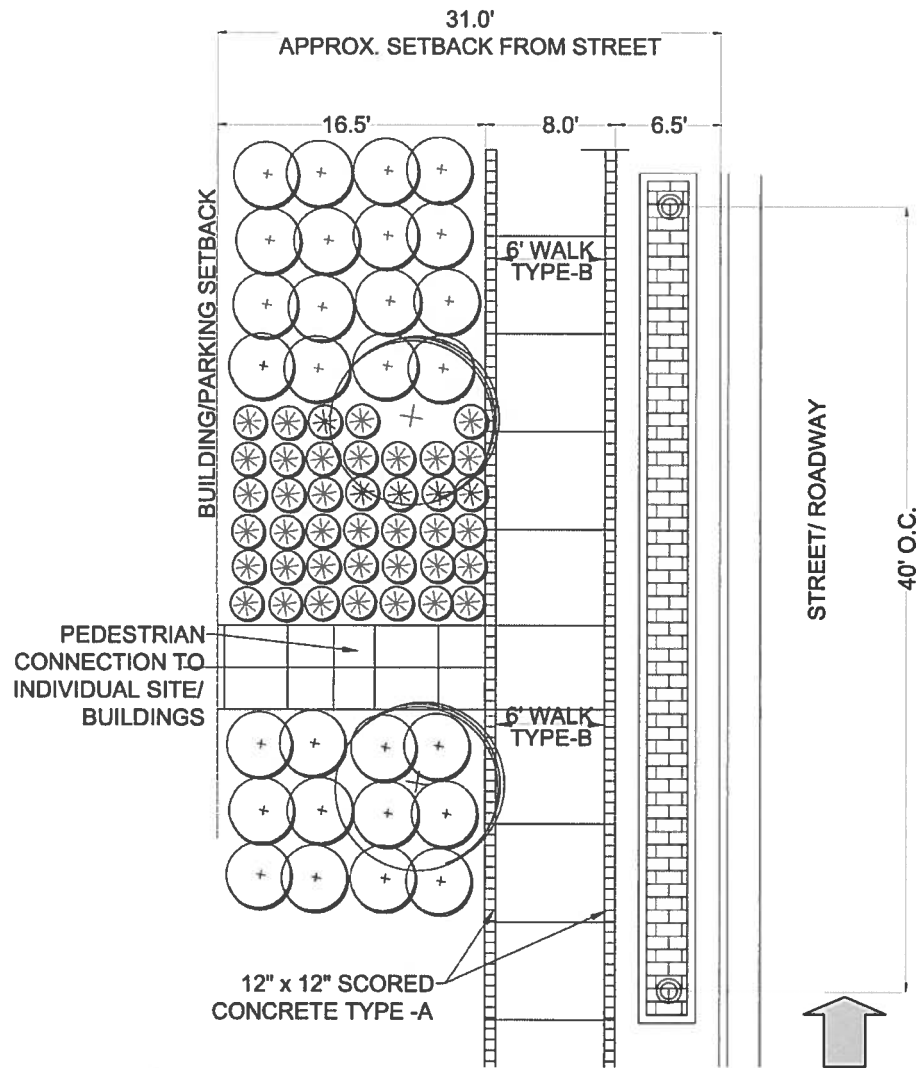
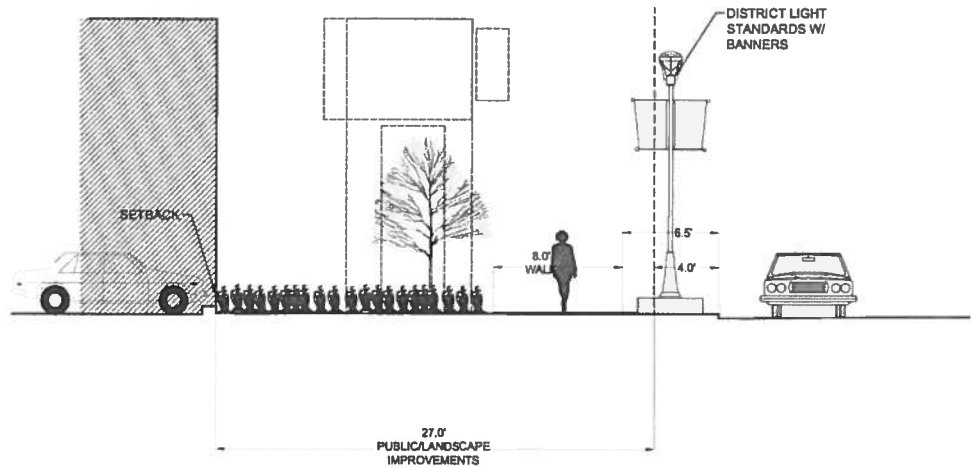

Cheyenne Road, North Side Section and Plan

South Nevada Urban Renewal District Streetscape Design Standards

The Raised Curb

The raised curb introduces additional vertical architectural character along the street, while providing a pedestrian buffer. Where right-of-way and existing site conditions allow, the South Nevada and Cheyenne road streetscape will introduce the raised curb element. Note the base material selections. The layout should be consistent with the street curb alignment in all applications. The raised curb should be limited or not be used if a clear 6' pathway cannot be maintained within existing site conditions.

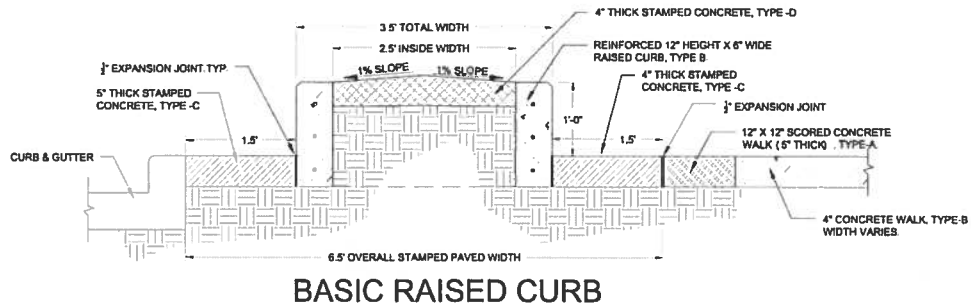

Pedestrian Light Fixtures



Lighting:

- FIXTURE MODEL: SRS SOLITAIRE PICOEMITTER LED
- POLE MODEL: 14' ROUND ALUMINIUM (NON-TAPERED)
- COLOR: Graphic Gray
- BANNERS: 18"X32" METAL

Light Spacing:

Street	Spacing	Comments
South Nevada	48' o.c.	*Provide Banners
Cheyenne Road	48' o.c.	*Provide Banners
Side Streets	60' o.c.	
South Nevada-Median	Replace Existing	*Double Arm 20' pole

*Every other pedestrian lamp poles on South Nevada and Cheyenne Rd shall receive banners. See banner section

(All fixtures are to be LED with 4000k color temperature lamps)

South Nevada Urban Renewal District Streetscape Design Standards

Median Light Fixtures

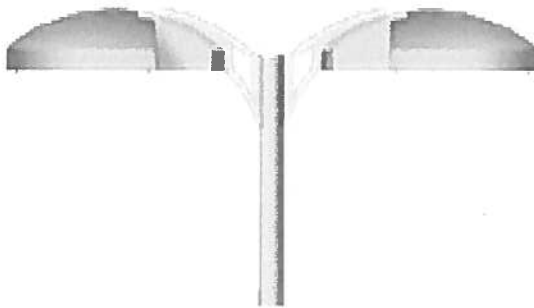

Lighting:

- FIXTURE MODEL: SRS SOLITAIRE PICOEMITTER LED
- DOUBLE ARM W/ FULL-CUT OFF
- POLE MODEL: 20' ROUND ALUMINIUM (TAPERED)
- COLOR: Graphic Gray
- BANNERS: 18"X32" METAL

(All fixtures are to be LED with 4000k color temperature lamps)

See notes related with Street Signalization below

Street Banners

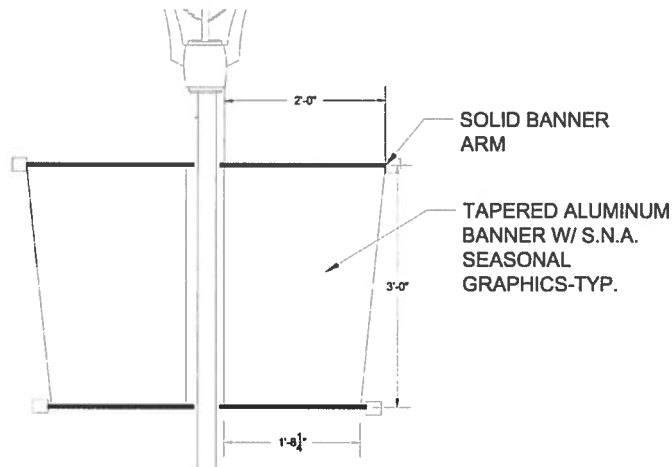

All banner arms for light poles will be aluminum from Valmont Structures. The banner arm selection is Burnville (breakaway) with stainless steel hardware. They will be painted Dark Gray to match lamp poles with round end cap

The proposed Business Improvement District (to be determined) and current property owners will be responsible for developing, managing and overseeing the banner program. The program will include specifying banner design and content for the District. No individual business will be allowed to advertise individual businesses within the banner program.

South Nevada Urban Renewal District Streetscape Design Standards

Seatwalls

The tapered concrete base seatwall is a key architectural element for unifying both new and existing developments into the new South Nevada Avenue corridor improvements and streetscape design. The developer should work closely with adjacent properties to incorporate the walls into the public improvement areas as noted within the right-of-way sections. The goal of the wall is to provide a foundation for the project signage, define pedestrian walkways, gateways and connections, and provide a balance of architecture along the street corridor. Each project should aim to provide walls along 20% to 40% of the development frontage on South Nevada Ave. and 20% of the frontage along Cheyenne Rd. No walls are required along the side streets, but they can be introduced in support of the overall district theme.

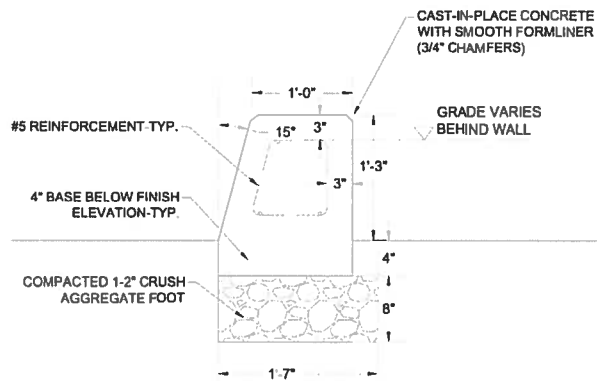
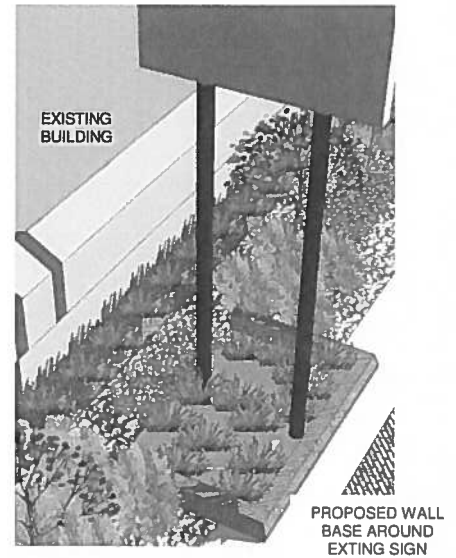

The reinforced seat walls will be poured in place on a compacted gravel base. The walls are to be poured with a standard gray concrete mix with a smooth form liner. Expansion and control joints will be provided 4' o.c. The joints should be tooled with a consistent 3/4" deep v-joint.

Street/Site Benches

The placement of benches are to be incorporated within the new and existing developments. The locations shall be in coordinate with the public improvement zones to introduce and maintain a balance of seating option for visitors. Two benches should be provided for every 100' of frontage. It is envisioned that the benches will be

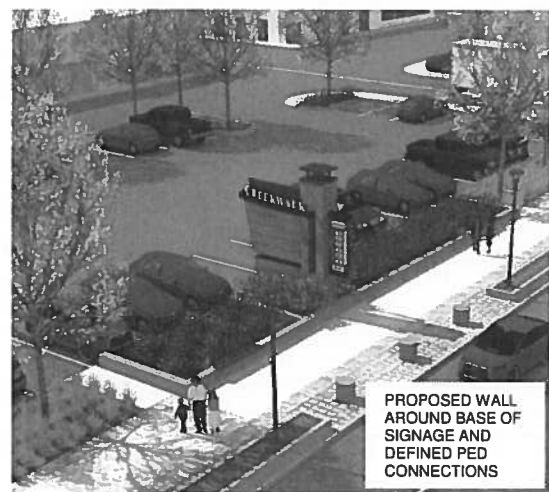

South Nevada Urban Renewal District Streetscape Design Standards

incorporated into the streetscape by either mounting them to the seat walls or on-grade along the walks. Care should be taken to assure that the bench location do not impede pedestrian circulation within the corridors. The benches can be included and counted for in the proposed bus stops found along the frontage.

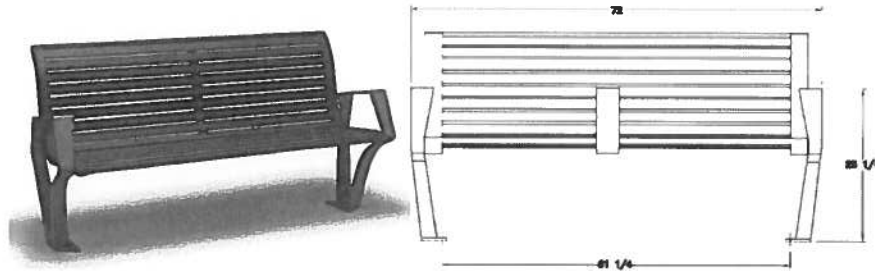

To be surface (special) mounted to the walls or on grade with the walk

Manufacture: Wabash Valley

Model: PL2M3 - Woodridge Collection 6' Bench with Back, with side and middle Arms

Color: Urbanscape Burst Rust powder-coat seat w/ Smoke Frame/legs

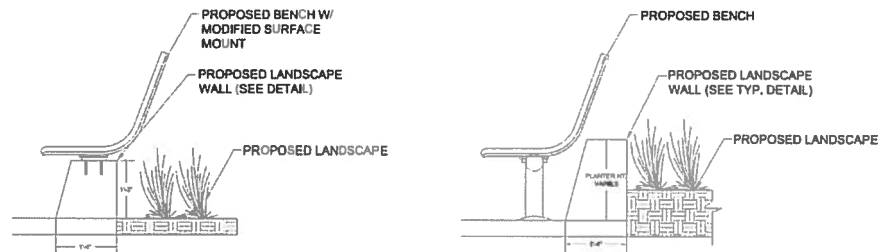

Bench mounting options:

Public Trash Receptacles

The receptacles provide an additional architecture/landscape element in the public improvement areas that help support the district theme, while helping to maintain a clean and trash free environment. The developer should coordinate the placement of trash receptacles with adjacent property owners to provide one (1) receptacle per 100' of frontage.



Manufacture: Wabash Valley

Model: PL2M3 - Woodridge Collection 32 gal. Receptacle w/ liner

Color: Urbanscape Burst Rust powder-coat Slats w/ Smoke Frame/top

South Nevada Urban Renewal District Streetscape Design Standards

Bollards



Precast reinforced concrete bollards
Models: Peterson Manufactured, UM24 24"x30"
Color: Etched, Dove Gray Etch
Spacing: 12' o.c.

E. Signage

The basic guideline for signage is to allow design flexibility within an overall framework, but perhaps more importantly, to establish a dialogue between representatives of the SNURD, existing stakeholders, City Planning and future developers in hopes of creating a more cohesive redevelopment district.

Wall Signage

Wall sign areas shall follow the regulations and development standards of the City Code with the exceptions and inclusions of the following Urban Renewal design criteria.

Wall signs should be located on the building façade as an integral part of the façade design, either centered within architectural elements or proportionally positioned as part of the overall façade design or located over a business's primary entrance/glass.

Wall sign locations shall be coordinated with approved freestanding sign locations. The overall layout should be coordinated to provide a balanced approach.

Wall signs that are located on adjacent and facing facades are discouraged.

Subject to City sign standards, secondary wall signs, blade, and projecting signs are encouraged to provide an additional layer of pedestrian connectivity to the development. Developers should familiarize themselves with adjacent properties sign locations, spacing, proportion and design configuration so as to best plan for their own sign program and its compatibility with neighboring sites. The overall layout should be coordinated to provide a balanced approach.

South Nevada Urban Renewal District Streetscape Design Standards

Freestanding Signs

Freestanding signs shall follow the regulations and development standards of the City Code in addition to the following Urban Renewal design guidelines:

Freestanding signs shall be uniformly spaced along the Nevada Avenue frontage as best possible. Developments should familiarize themselves with neighboring signage locations in planning their sign locations.

Freestanding signs shall incorporate the tapered South Nevada Ave. standard concrete seatwall base or planter seat walls into the design of any new freestanding sign. Existing freestanding signs shall add the SNA standard base/wall to their signs whenever possible. The tapered concrete base/wall is a key architectural element for unifying both new and existing developments into the new South Nevada Avenue corridor improvements (See Primary Sign Feature -D.)

Freestanding signs shall be located forward on the site adjacent to the Nevada Avenue and Cheyenne Road sidewalk setbacks. The pier, column or structural element for the sign shall be located on the street side of the sign cabinet (See Primary Sign Feature -A.). The primary tenant text panels shall be positioned to the building side of the sign's pier or column element (See Primary Sign Feature -B.).

The pier, column or structural element of the sign shall be externally illuminated to highlight the main architectural element and design character of the sign regardless of any tenant sign panel illumination. The column feature should consist of steel and or masonry materials that provide a strong connection to the individual project architecture.

For mixed use or multi-tenant developments, or developments requiring large signs, signage that recognizes or celebrates South Nevada Avenue as its destination or district is highly encouraged (See Primary Sign Feature - E.). Such signs can be located to the street side of the structural pier or column of the freestanding sign and may project a maximum of 2'-6" over the dedicated sidewalk easement. The overhanging side should provide a minimum 10' clearance over the sidewalk. These sign standards shall not reduce the size or height requirements/allowances as provided in the City Code.

South Nevada Urban Renewal District Streetscape Design Standards

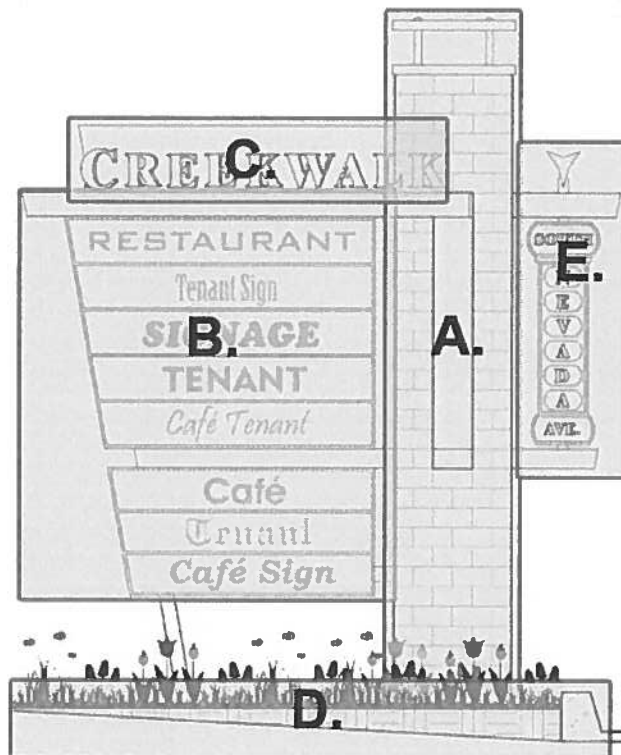

Primary Sign Features

Freestanding signs shall incorporate low plantings around the base of the sign in compliance with the South Nevada Ave. planting guidelines and associated seatwalls.

The positioning of the freestanding sign shall be coordinated with any pedestrian access points from the frontage sidewalk.

Signage that announces the name of the center or business as a place unto itself is encouraged to be different than that of the typical tenant signage. Special fonts, mounting, lighting and panel shapes should be considered to create variety and interest for the sign (See Primary Sign Feature -C.).

Tenant sign panels shall be constructed of aluminum panels with routed letters with acrylic or pushed acrylic text and graphics. Illuminated acrylic or plastic back panels are highly discouraged for any new development and/or replacement signage (See Primary Sign Feature-B.).

Electronic Message Centers (EMC's) signs are not allowed.

Sign Area and Sign Height

As defined by the City Sign Code

South Nevada Urban Renewal District Streetscape Design Standards

Building Design

Buildings are encouraged to be located forward on the site adjacent to the streetscape setback. Pedestrian amenities such as windows, patios, seating areas, planters and architectural elements that break down or reduce the visual scale of buildings are strongly encouraged.

Architectural elements that define pedestrian scale and activity such as awnings, sconces, windows, and architectural relief are encouraged with secondary signage integral and proportional in scale to these elements.

Building profiles shall be varied with architectural elements to break up the box-like forms.

Quality building materials are highly encouraged with accent materials such as brick, stone or metal strongly recommended.

Buildings should treat all facades that are visible to the public equally with variation, interest and detail.

F. Landscape

The landscape design intent supports the overall framework for the streetscape enhancing the pedestrian and business environment. The planting guidelines outline a planting scheme that groups planting types into larger blocks and masses to encourage a consistent and bold landscape pattern along the street. The planting design is also encouraged to embrace entry ways, sign placements and intersections. The landscape planting designs shall follow the regulations and development standards of the City Code with the exceptions and inclusions of the following Urban Renewal design criteria. The final landscape design shall be adaptable to commercial sightlines and view corridor.



Landscape massing and tree grouping

South Nevada Urban Renewal District Streetscape Design Standards

Recommended Trees

Tree shall be planted in groups of (3) three or more to reinforce the mass of the canopy along the street, while also providing openings and exposure for business frontages and signage.

- AUTUMN BLAZE PEAR (*Pyrus calleryana* 'Autumn Blaze') ,20' o.c, 2"cal
- SUNBURST HONEYLOCUST (*Gleditsia triacanthos* 'Sunburst'), 20' o.c, 2"cal
- LITTLELEAF LINDEN (*Tilia cordata*) 20' o.c.
- SPRING SNOW CRAB APPLE (*Malus x* 'Spring Snow'), 20' o.c, 2"cal

Recommended Shrubs

Individual shrub types are to be planted in groups of 5 or more to reinforce the landscape massing envisioned as part of the streetscape.

- BURGUNDY CAROUSEL BARBERRY (*Berberis thunbergii* 'Bailtwo'), 48" O.C. # 5 GAL
- GOLD FLAME SPIREA (*Spiraea x bumalda* 'Goldflame'), 36" O.C. # 5 GAL
- Anthony Waterer Spirea (*Spiraea japonica* 'Anthony Waterer') 36" O.C. #5 GAL.
- DWARF FRAGRANT SUMAC (*Rhus aromatica* 'Gro-Low') , 48" O.C. # 5 GAL
- BIRD'S NEST SPRUCE (*Picea abies* 'Nidiformis'), 36" O.C, #5 GAL (24"TO 42")
- Dwarf MUGO PINE (*Pinus mugo pumilio*), 30" O.C, #5 GAL (30"TO 48")
- Arcadia Juniper (*Juniper Sabina* 'Arcadia') 36" O.C. #5 GAL
- Broadmoor Juniper (*Juniper Sabina* 'Broadmoor') 36" O.C. #5 GAL

Recommended Ornamental Grasses

Individual Grass types are to be planted in groups of 10 or more to reinforce the landscape massing envisioned as part of the streetscape

- BLUE OAT GRASS (*Helictotrichon sempervirens*), 18" O.C, #1 GAL
- LITTLE BLUE STEM (*Schizachyrium scoparium*), 18" O.C, #1 GAL
- PURPLE FOUNTAIN GRASS (*Pennisetum setaceum* 'Rubrum'), 24" O.C, #1 GAL

South Nevada Urban Renewal District Streetscape Design Standards

Exhibit A: Proposed South Nevada Signalization Plan per City Traffic

