

TRAFFIC IMPACT STUDY

For

**Dream Centers Campus
Colorado Springs, Colorado**

February 2024
Revised: March 2024

Prepared for:

Dream Centers
11025 Voyager Parkway
Colorado Springs, Colorado 80921

Prepared by:



SM ROCHA, LLC
TRAFFIC AND TRANSPORTATION CONSULTANTS

8700 Turnpike Drive, Suite 240
Westminster, Colorado 80031
(303) 458-9798

6 South Tejon Street, Suite 618
Colorado Springs, Colorado 80903
(719) 203-6639

Project Manager:
Brandon Wilson, EIT
Project Engineer:
Megan Bock, EIT

Engineer in Responsible Charge:
Fred Lantz, PE



Table of Contents

I. Introduction 1

 Project Overview..... 1

 Study Area Boundaries 1

 Site Description..... 1

 Existing and Committed Surface Transportation Network..... 5

II. Existing Traffic Conditions 7

 Peak Hour Intersection Levels of Service – Existing Traffic..... 10

 Existing Traffic Analysis Results 11

III. Future Traffic Conditions Without Proposed Development..... 12

 Peak Hour Intersection Levels of Service – Background Traffic 17

 Background Traffic Analysis Results – Year 2026 17

 Background Traffic Analysis Results – Year 2044 18

IV. Proposed Project Traffic 19

 Trip Generation..... 19

 Adjustments to Trip Generation Rates 20

 Trip Distribution..... 21

 Trip Assignment..... 21

V. Future Traffic Conditions With Proposed Developments 24

VI. Project Impacts 29

 Peak Hour Intersection Levels of Service – Total Traffic 29

 Total Traffic Analysis Results Upon Development Build-Out 32

 Queue Length Analysis..... 33

 Recommended Improvements 33

VII. Conclusion 34

List of Figures

Figure 1 – Location.....3
 Figure 2 – Land Use Plan.....4
 Figure 3 – Existing Traffic Volumes.....8
 Figure 4 – Existing Traffic Intersection Geometry.....9
 Figure 5 – Background Traffic Volumes – Year 2026.....13
 Figure 6 – Background Traffic Intersection Geometry – Year 2026.....14
 Figure 7 – Background Traffic Volumes – Year 2044.....15
 Figure 8 – Background Traffic Intersection Geometry – Year 2044.....16
 Figure 9 – Distribution and Site-Generated Assignment – Phase One.....22
 Figure 10 – Distribution and Site-Generated Assignment – Build-Out.....23
 Figure 11 – Total Traffic Volumes – Year 2026.....25
 Figure 12 – Total Traffic Intersection Geometry – Year 2026.....26
 Figure 13 – Total Traffic Volumes– Year 2044.....27
 Figure 14 – Total Traffic Intersection Geometry – Year 2044.....28

List of Tables

Table 1 – Intersection Capacity Analysis Summary – Existing Traffic.....11
 Table 2 – Intersection Capacity Analysis Summary – Background Traffic – Year 2026.....17
 Table 3 – Intersection Capacity Analysis Summary – Background Traffic – Year 2044.....18
 Table 4 – Trip Generation Rates.....19
 Table 5 – Trip Generation Summary.....20
 Table 6 – Trip Generation Summary with Reductions.....21
 Table 7 – Intersection Capacity Analysis Summary – Total Traffic – Year 2026.....30
 Table 8 – Intersection Capacity Analysis Summary – Total Traffic – Year 2044.....31

Appendices

APPENDIX A TRAFFIC COUNT DATA
 APPENDIX B SIGNAL TIMING INFORMATION
 APPENDIX C INTERNAL CAPTURE WORKSHEETS
 APPENDIX D LEVEL OF SERVICE DEFINITIONS
 APPENDIX E CAPACITY WORKSHEETS

I. Introduction

Project Overview

This traffic impact study is provided as a planning document and addresses the capacity, geometric, and control requirements associated with the development entitled Dream Centers Campus.

This traffic impact study has been revised to address City review comments dated 03/21/2024 regarding discrepancy between long-term background and total traffic intersection operations.

This proposed mixed-use development consists of multifamily housing, an office building, general retail space, and a sit-down restaurant. The development is located on the southeast corner of S Union Boulevard and Airport Road in Colorado Springs, Colorado.

Study Area Boundaries

The study area to be examined in this analysis encompasses the area bounded by S Union Boulevard, Airport Road, and Eastlake Boulevard, and includes the proposed site access drives.

Figure 1 illustrates location of the development site and study area.

Site Description

Land for the development is currently occupied by a mix of land uses including a liquor store, a charter school, an outdoor playground, and office space, and is surrounded by a mix of residential and recreational land uses.

The proposed development is conceptual and no specific land uses and densities have been determined. However, for purposes of this analysis, there is assumed to be construction for approximately 103 multifamily dwelling units, 134 multifamily dwelling units with ground floor commercial, approximately 20,000 square feet of office, 18,000 square feet of retail, and an approximate 12,000 square-foot sit-down restaurant, all within three zoning areas of the site.

Existing access to the development is provided via one full-movement access onto Eastlake Boulevard (referred to as Access A). New site access drives are being proposed at the following locations: one full-movement access onto S Union Boulevard (referred to as Access B), one right-in / right-out access onto Airport Road (referred to as Access C), two full-movement accesses onto Airport Road (referred to as Access D and Access E), and one right-in / right-out access onto Eastlake Boulevard (referred to as Access F).

For purposes of this study, it is anticipated that development construction would be phased. Phase One is understood to consist of partial build-out of Area 2 supporting 73 multifamily dwelling units with construction to be completed by Year 2026, and Phase Two will consist of total development build-out for Areas 1, 2, and 3.

General site and access locations are shown on Figure 1. A land use plan, as prepared by Echo Architecture + Interiors, is shown on Figure 2. This plan is provided for illustrative purposes only.



Figure 1
SITE LOCATION

March 2024
Page 3

DREAM CENTERS CAMPUS
Traffic Impact Study

SM ROCHA, LLC
Traffic and Transportation Consultants



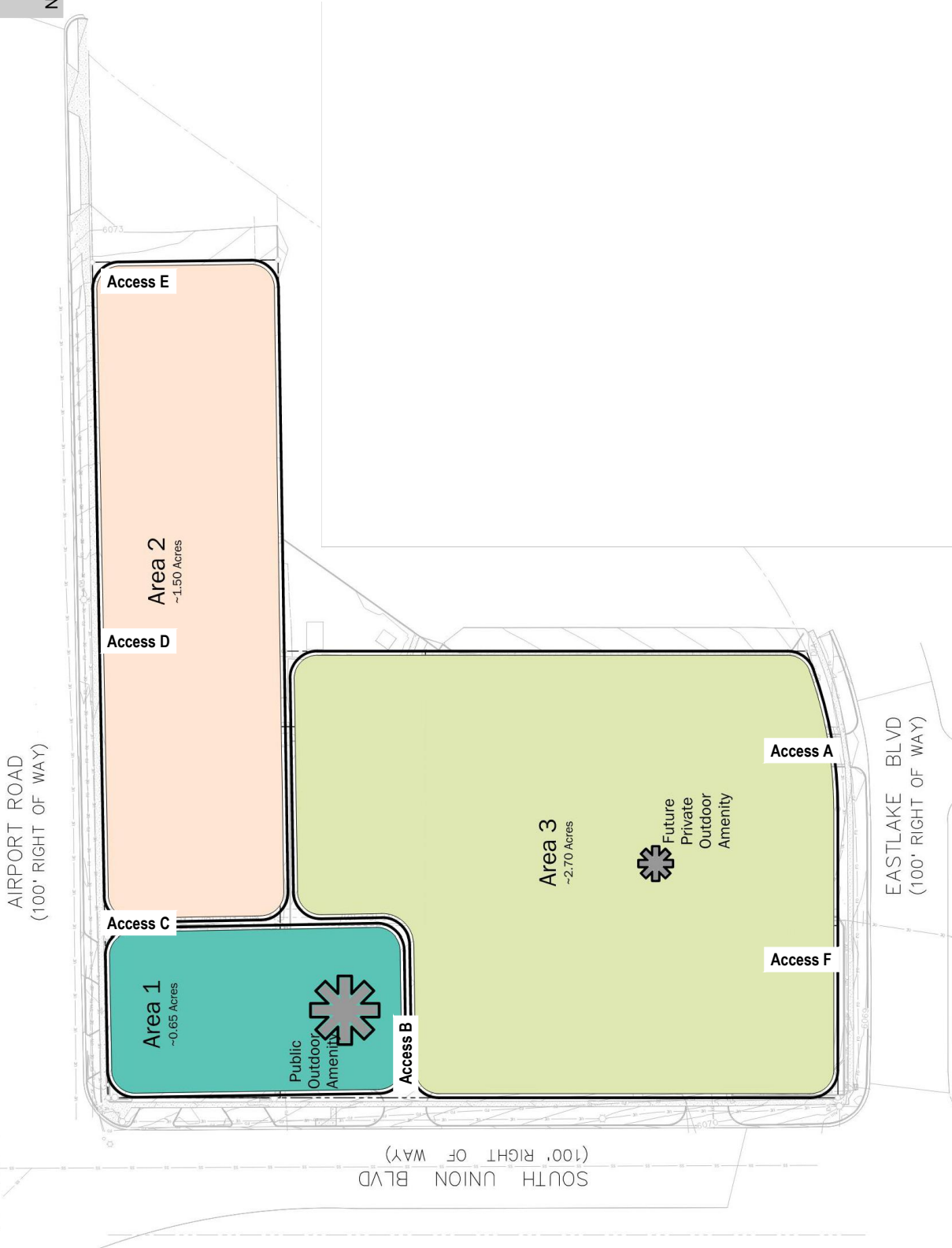

Existing and Committed Surface Transportation Network

Within the study area, S Union Boulevard is the primary roadway that will accommodate traffic to and from the proposed development. The secondary roadways include Airport Road, Eastlake Boulevard, Manitoba Drive, Erie Road, Huron Road, and Salt Drive. A brief description of each roadway, based on the City's Major Thoroughfare Plan (MTP)¹ and Traffic Criteria Manual², is provided below:

S Union Boulevard is a north-south principal arterial roadway supporting a five-lane cross-section (two through lanes in each direction with a center two-way left-turn lane) with a combination of shared and exclusive turn lanes at the intersections within the study area. S Union Boulevard provides a posted speed limit of 35 MPH.

Airport Road is an east-west minor arterial roadway supporting a three-lane cross-section (one through lane in each direction with a center two-way left-turn lane) with a combination of shared and exclusive turn lanes at the intersections within the study area. Airport Road provides a posted speed limit of 40 MPH.

Eastlake Boulevard is a generally northeast-southwest roadway supporting a three-lane cross-section (one through lane in each direction with a center two-way left-turn lane) with a combination of shared and exclusive turn lanes at the intersections within the study area. Eastlake Boulevard is unclassified in the City's MTP. However, per Sections 15.0 and 16.0 of the City's Traffic Criteria Manual, and the roadway's estimated right-of-way (ROW) width, Eastlake Boulevard is assumed to be classified as a collector roadway and provides a posted speed limit of 30 MPH.

Manitoba Drive is a north-south roadway having two through lanes (one lane in each direction) with shared turn lanes at the intersection within the study area. Manitoba Drive is unclassified in the City's MTP. However, per Sections 15.0 and 16.0 of the City's Traffic Criteria Manual, and the roadway's estimated ROW width, Manitoba Drive is assumed to be classified as a local residential roadway with an assumed speed limit of 25 MPH.

Erie Road is a north-south roadway having two through lanes (one lane in each direction) with shared turn lanes at the intersection within the study area. Erie Road is unclassified in the City's MTP. However, per Sections 15.0 and 16.0 of the City's Traffic Criteria Manual, and the roadway's estimated ROW width, Erie Road is assumed to be classified as a local residential roadway with an assumed speed limit of 25 MPH.

¹ City of Colorado Springs Major Thoroughfare Plan, City of Colorado Springs, Department of Public Works, June 2, 2022.

² Engineering Criteria Manual, Section III: Traffic Criteria Manual, City of Colorado Springs City Engineering, July 2010.

Huron Road is a north-south roadway having two through lanes (one lane in each direction) with shared turn lanes at the intersection within the study area. Huron Road is unclassified in the City's MTP. However, per Sections 15.0 and 16.0 of the City's Traffic Criteria Manual, and the roadway's estimated ROW width, Huron Road is assumed to be classified as a local residential roadway with an assumed speed limit of 25 MPH.

Salt Drive is an east-west roadway having two through lanes (one lane in each direction) with shared turn lanes at the intersection within the study area. Salt Drive is unclassified in the City's MTP. However, per Sections 15.0 and 16.0 of the City's Traffic Criteria Manual, and the roadway's estimated ROW width, Salt Drive is assumed to be classified as a local residential roadway with an assumed speed limit of 25 MPH.

The study intersection of S Union Boulevard and Eastlake Boulevard is signalized. All other study intersections operate under a stop-controlled condition. A stop-controlled intersection is defined as a roadway intersection where vehicle rights-of-way are controlled by one or more "STOP" signs.

No regional or specific improvements for the above-described roadways are known to be planned or committed at this time. The study area roadways appear to be built to their ultimate cross-sections.

II. Existing Traffic Conditions

Morning (AM) and afternoon (PM) peak hour traffic counts were collected at the Airport Road intersections with S Union Boulevard and Eastlake Boulevard, and the Eastlake Boulevard intersections with S Union Boulevard, Manitoba Drive, Erie Road, Huron Road, and Salt Drive. Average daily traffic (ADT) volumes were collected over a 24-hour period on Eastlake Boulevard. Counts were collected on Thursday, January 11, 2024, with AM peak hour counts being collected during the period of 7:00 a.m. to 9:00 a.m. and PM peak hour counts being collected during the period of 4:00 p.m. to 6:00 p.m.

Newly collected counts representing existing traffic volumes are shown on Figure 3. Existing intersection geometry is shown on Figure 4. Traffic count data is included for reference in Appendix A.

Existing signal timing parameters for S Union Boulevard and Eastlake Boulevard were obtained from the City and used throughout this study to the best extent possible in order to remain consistent with existing signal coordination plans. City signal timing information received is included for reference in Appendix B.



Not to Scale

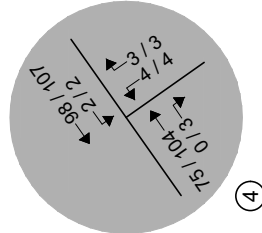
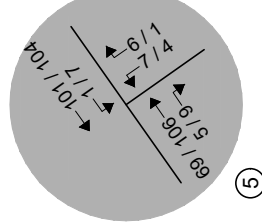
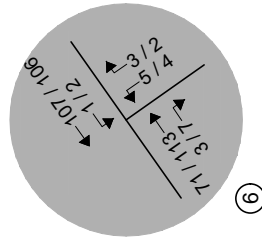
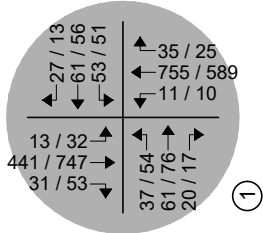
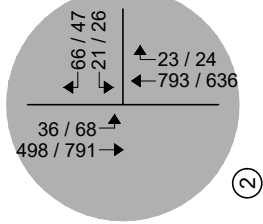
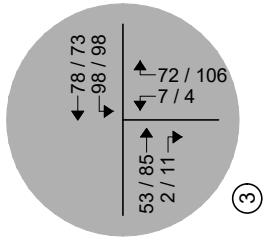
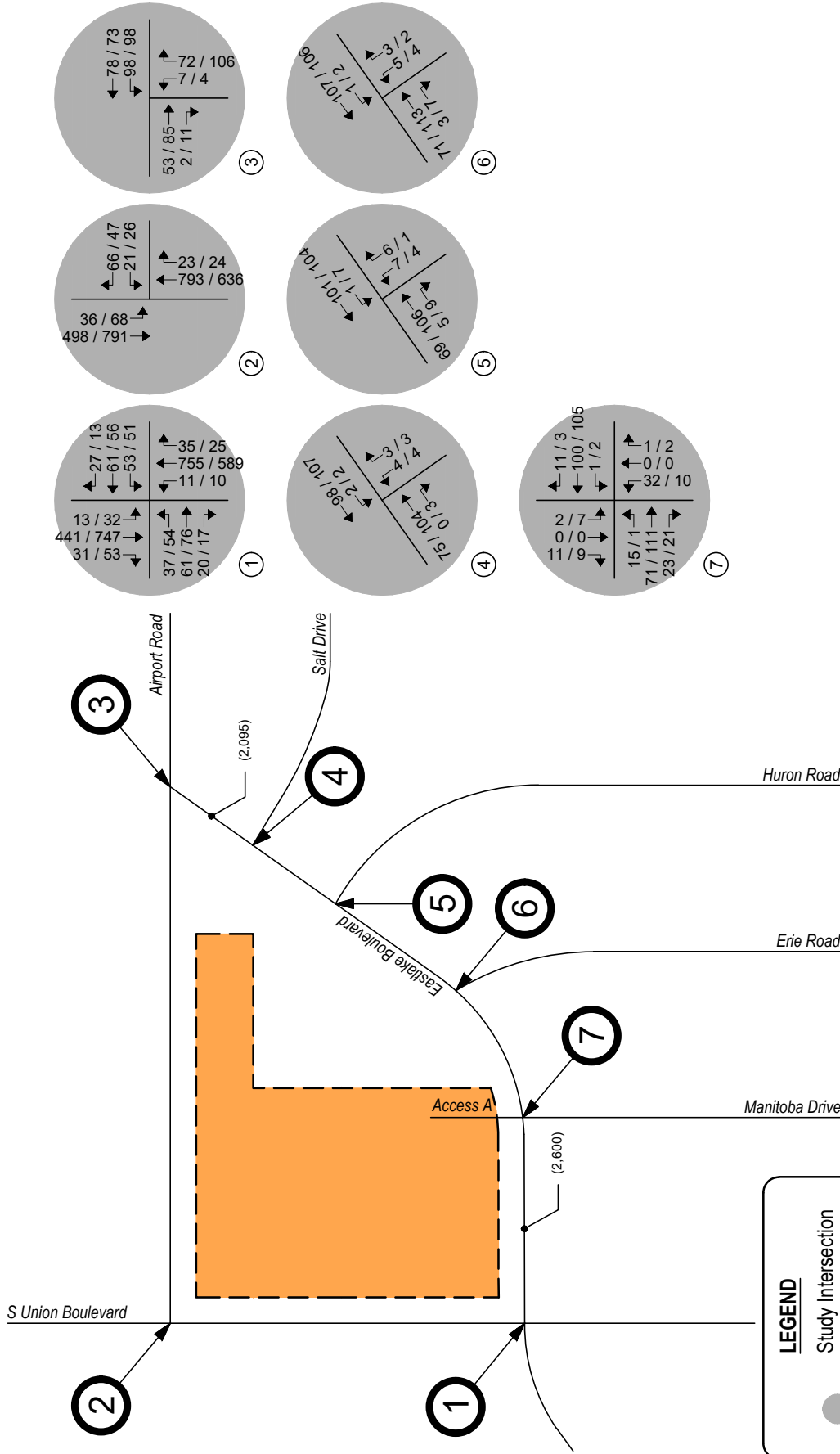

Figure 3
EXISTING TRAFFIC
 Volumes
 AM / PM Peak Hour
 (ADT) : Average Daily Traffic





North

Not to Scale

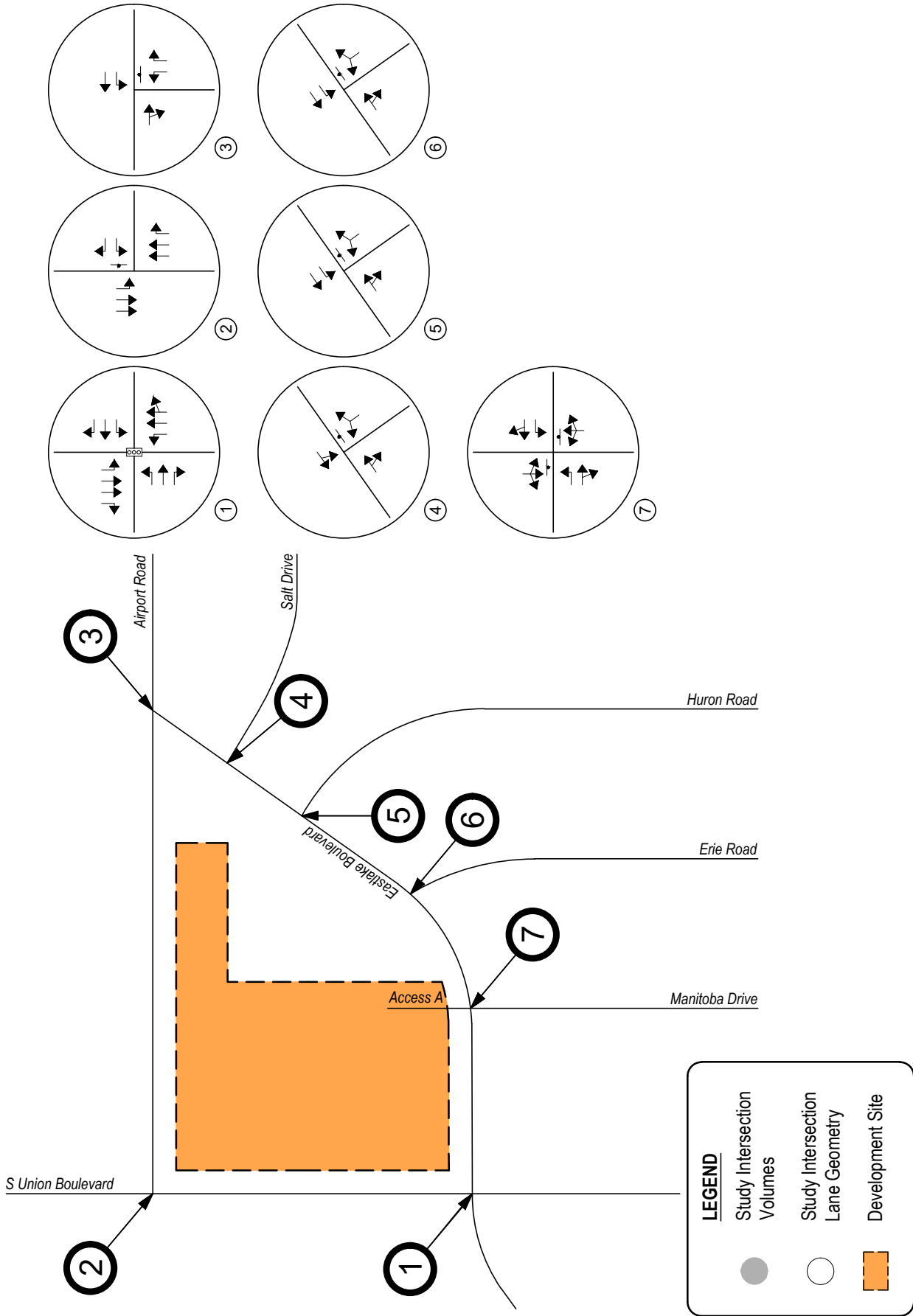

Figure 4
EXISTING TRAFFIC
Intersection Geometry



Peak Hour Intersection Levels of Service – Existing Traffic

The Signalized and Unsignalized Intersection Analysis techniques, as published in the Highway Capacity Manual (HCM), 6th Edition, by the Transportation Research Board and as incorporated into the SYNCHRO computer program, were used to analyze the study intersections for existing and future traffic conditions. These nationally accepted techniques allow for the determination of intersection level of service (LOS) based on the congestion and delay of each traffic movement.

Level of service is a method of measurement used by transportation professionals to quantify a driver's perception of travel conditions that include travel time, number of stops, and total amount of stopped delay experienced on a roadway network. The HCM categorizes level of service into a range from "A" which indicates little, if any, vehicle delay, to "F" which indicates a level of operation considered unacceptable to most drivers. These levels of service grades with brief descriptions of the operating condition, for unsignalized and signalized intersections, are included for reference in Appendix D and have been used throughout this study.

The level of service analyses results for existing conditions are summarized in Table 1.

Intersection capacity worksheets developed for this study are provided in Appendix E.

Table 1 – Intersection Capacity Analysis Summary – Existing Traffic

INTERSECTION LANE GROUPS	LEVEL OF SERVICE	
	AM PEAK HOUR	PM PEAK HOUR
S Union Boulevard / Eastlake Boulevard (Signalized)	A (7.2)	A (7.3)
S Union Boulevard / Airport Road (Stop-Controlled)		
Westbound Left	B	C
Westbound Right	B	A
Southbound Left	A	A
Airport Road / Eastlake Boulevard (Stop-Controlled)		
Westbound Left	A	A
Northbound Left	B	B
Northbound Right	A	A
Eastlake Boulevard / Salt Drive (Stop-Controlled)		
Southwestbound Left and Through	A	A
Northwestbound Left and Right	A	A
Eastlake Boulevard / Huron Road (Stop-Controlled)		
Southwestbound Left	A	A
Northwestbound Left and Right	A	A
Eastlake Boulevard / Erie Road (Stop-Controlled)		
Southwestbound Left	A	A
Northwestbound Left and Right	A	A
Eastlake Boulevard / Manitoba Drive (Stop-Controlled)		
Eastbound Left	A	A
Westbound Left	A	A
Northbound Left, Through, and Right	B	B
Southbound Left, Through, and Right	A	A

Key: Signalized Intersection: Level of Service (Control Delay in sec/v eh)
 Stop-Controlled Intersection: Level of Service

Existing Traffic Analysis Results

Under existing conditions, operational analysis shows that the signalized intersection of S Union Boulevard with Eastlake Boulevard has overall operations at LOS A during the morning and afternoon peak traffic hours.

The stop-controlled intersection of S Union Boulevard with Airport Road has turn movement operations at or better than LOS B during the morning peak traffic hour and LOS C or better during the afternoon peak traffic hour.

The stop-controlled intersections of Eastlake Boulevard with Airport Road and Manitoba Drive have turn movement operations at or better than LOS B during both peak traffic hours.

All other stop-controlled study intersections along Eastlake Boulevard have turn movement operations at LOS A during both peak traffic hours.

III. Future Traffic Conditions Without Proposed Development

Background traffic is the traffic projected to be on area roadways without consideration of the proposed development. Background traffic includes traffic generated by development of vacant parcels in the area.

To account for projected increases in background traffic for Years 2026 and 2044, a compounded annual growth rate was determined using historical traffic data for the surrounding area provided by the Colorado Department of Transportation's (CDOT) Online Transportation Information System (OTIS), which anticipates a 20-year growth rate between one and two percent. Therefore, in order to provide for a conservative analysis, a growth rate of two percent was applied to existing traffic volumes. This annual growth rate is also consistent with regional growth projections and the level of in-fill development expected within the area.

Pursuant to the non-committed area roadway improvements discussed in Section I, Year 2026 and Year 2044 background traffic conditions assume no roadway improvements to accommodate regional transportation demands. This assumption provides for a conservative analysis. Year 2044 assumes existing signal timing parameters for S Union Boulevard and Eastlake Boulevard with optimized intersection splits in effort to better long-term intersection performance.

Projected background traffic volumes and intersection geometry for Year 2026 are shown on Figure 5 and Figure 6, respectively.

Projected background traffic volumes and intersection geometry for Year 2044 are shown on Figure 7 and Figure 8, respectively.



Not to Scale

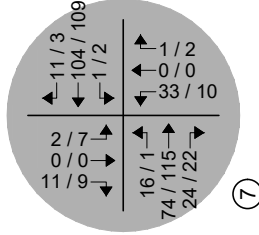
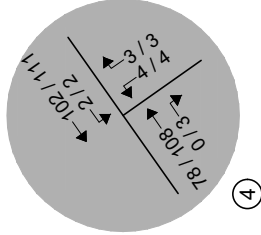
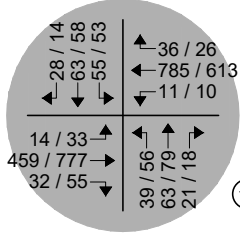
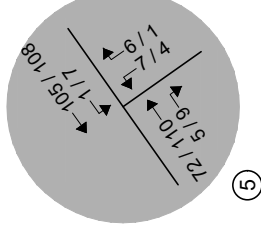
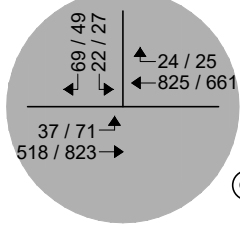
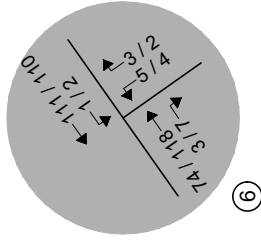
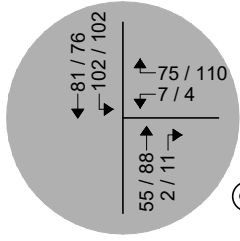
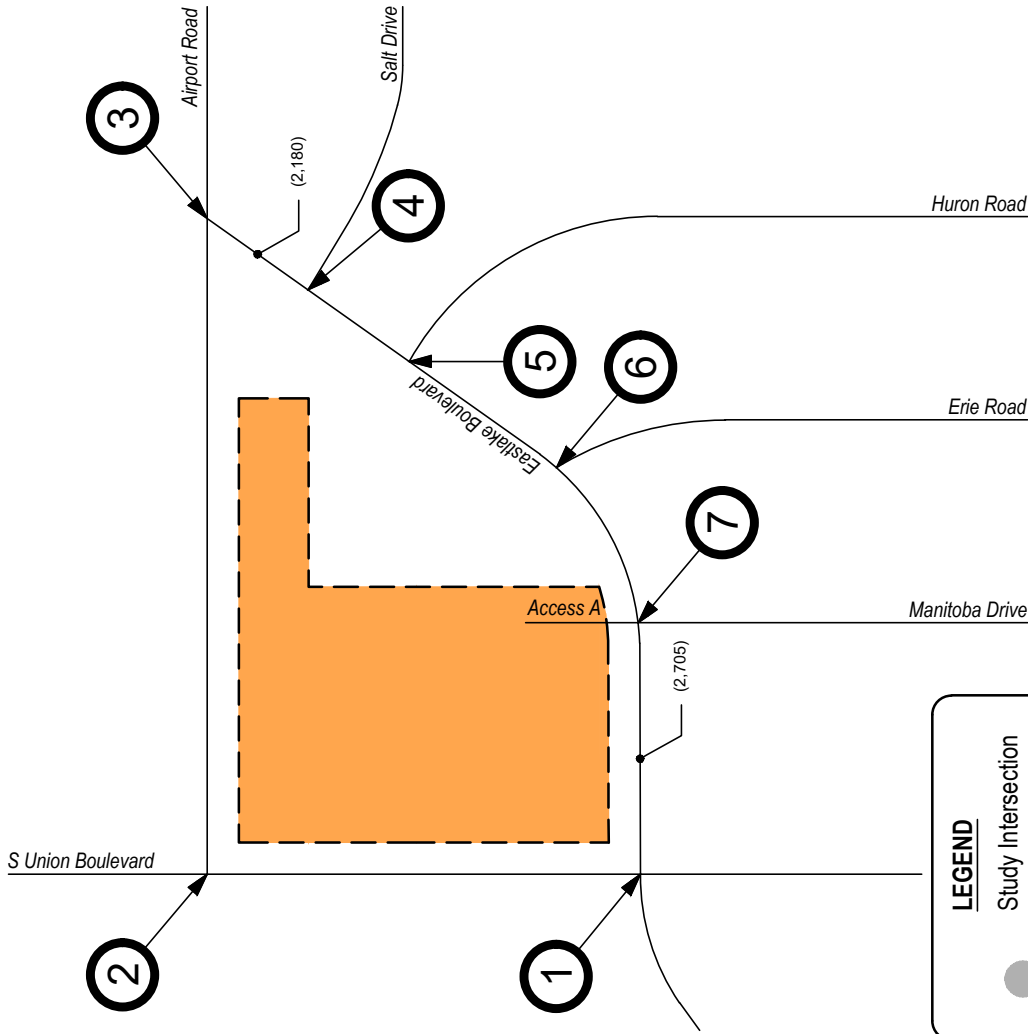

LEGEND

- Study Intersection Volumes
- Study Intersection Lane Geometry
- Development Site

Figure 5
BACKGROUND TRAFFIC - YEAR 2026
Volumes

AM / PM Peak Hour
(ADT) : Average Daily Traffic





North

Not to Scale

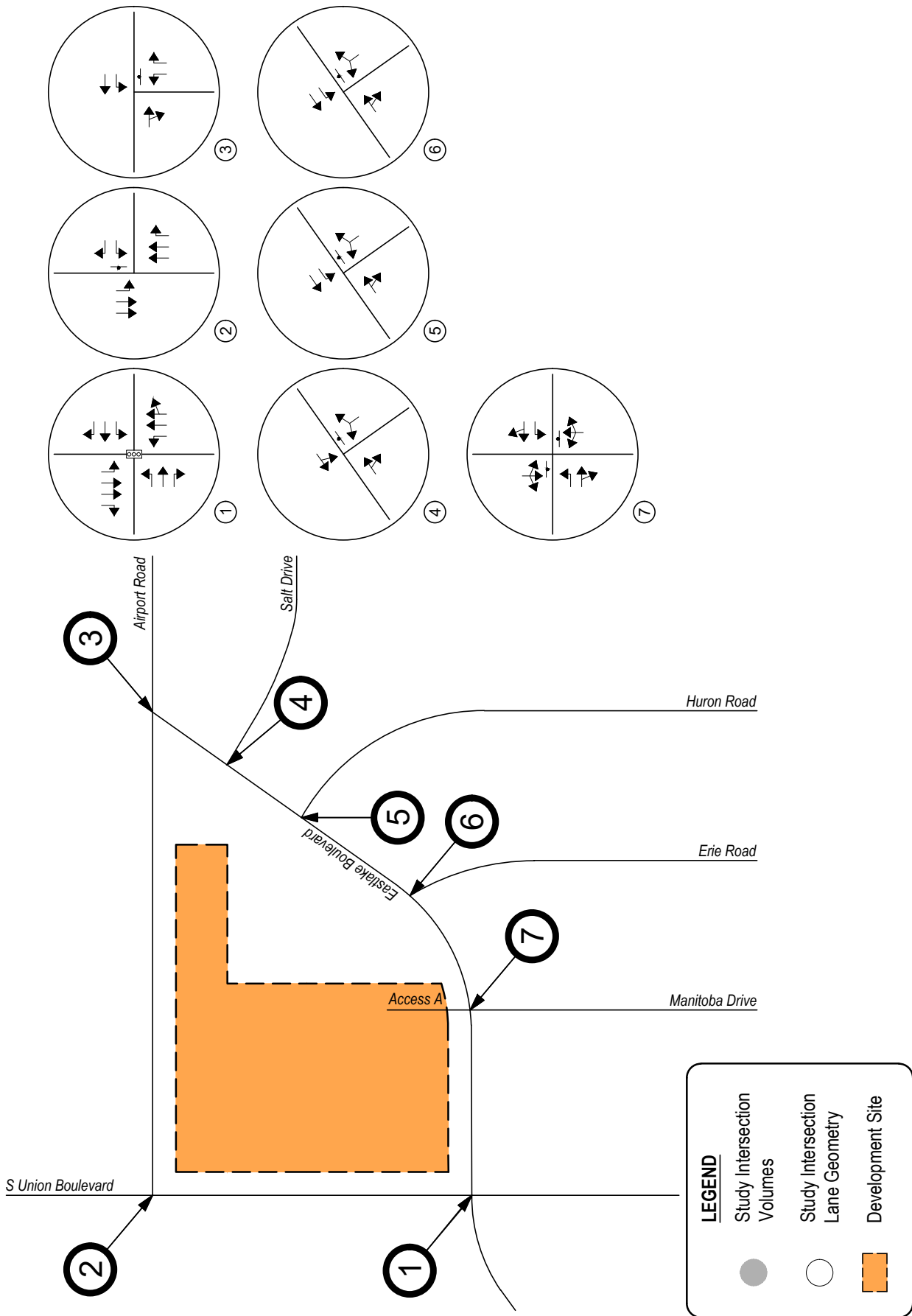

Figure 6
BACKGROUND TRAFFIC - YEAR 2026
Intersection Geometry





Not to Scale

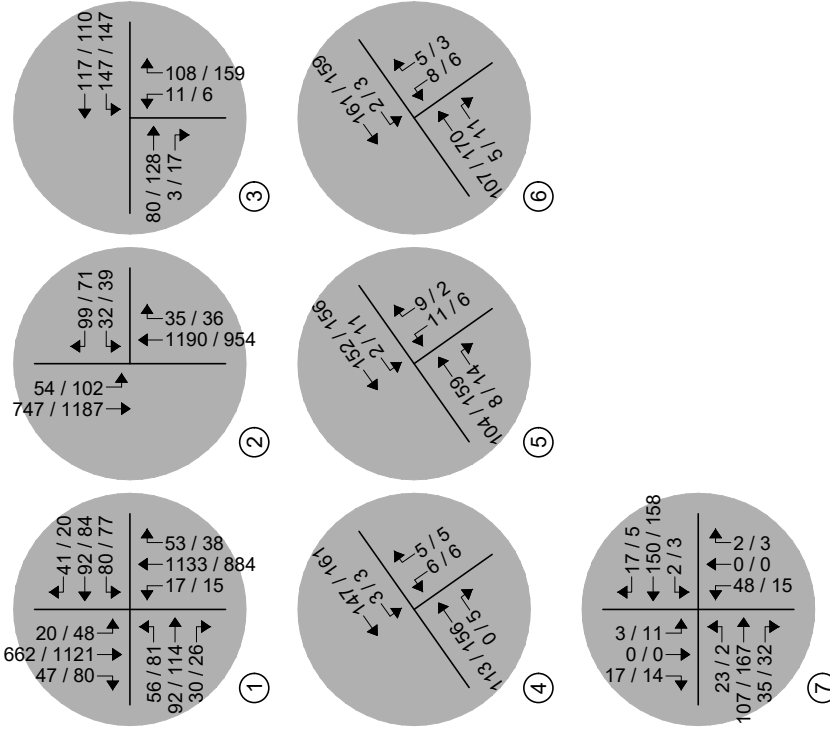
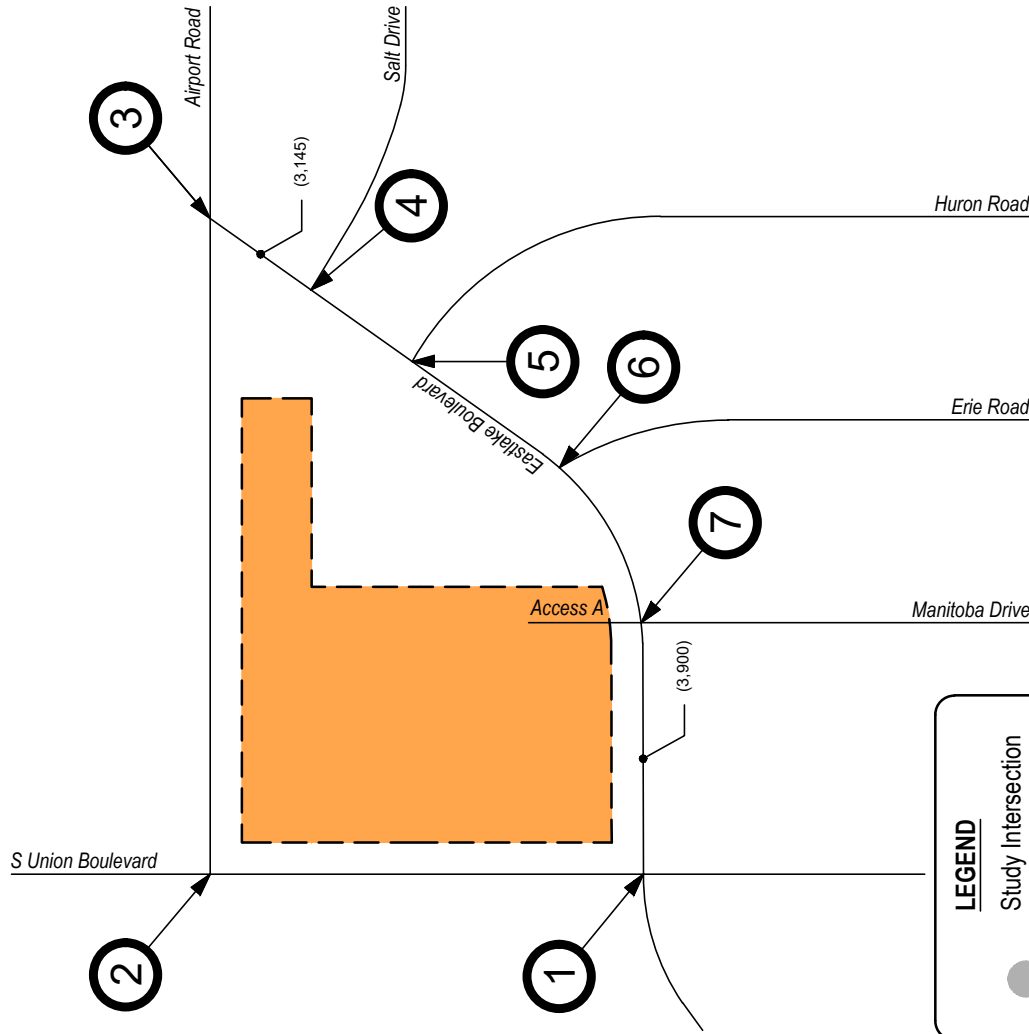

Figure 7
BACKGROUND TRAFFIC - YEAR 2044
 Volumes

AM / PM Peak Hour
 (ADT) : Average Daily Traffic

LEGEND

- Study Intersection Volumes
- Study Intersection Lane Geometry
- Development Site

DREAM CENTERS CAMPUS
 Traffic Impact Study



SM ROCHA, LLC
 Traffic and Transportation Consultants



North

Not to Scale

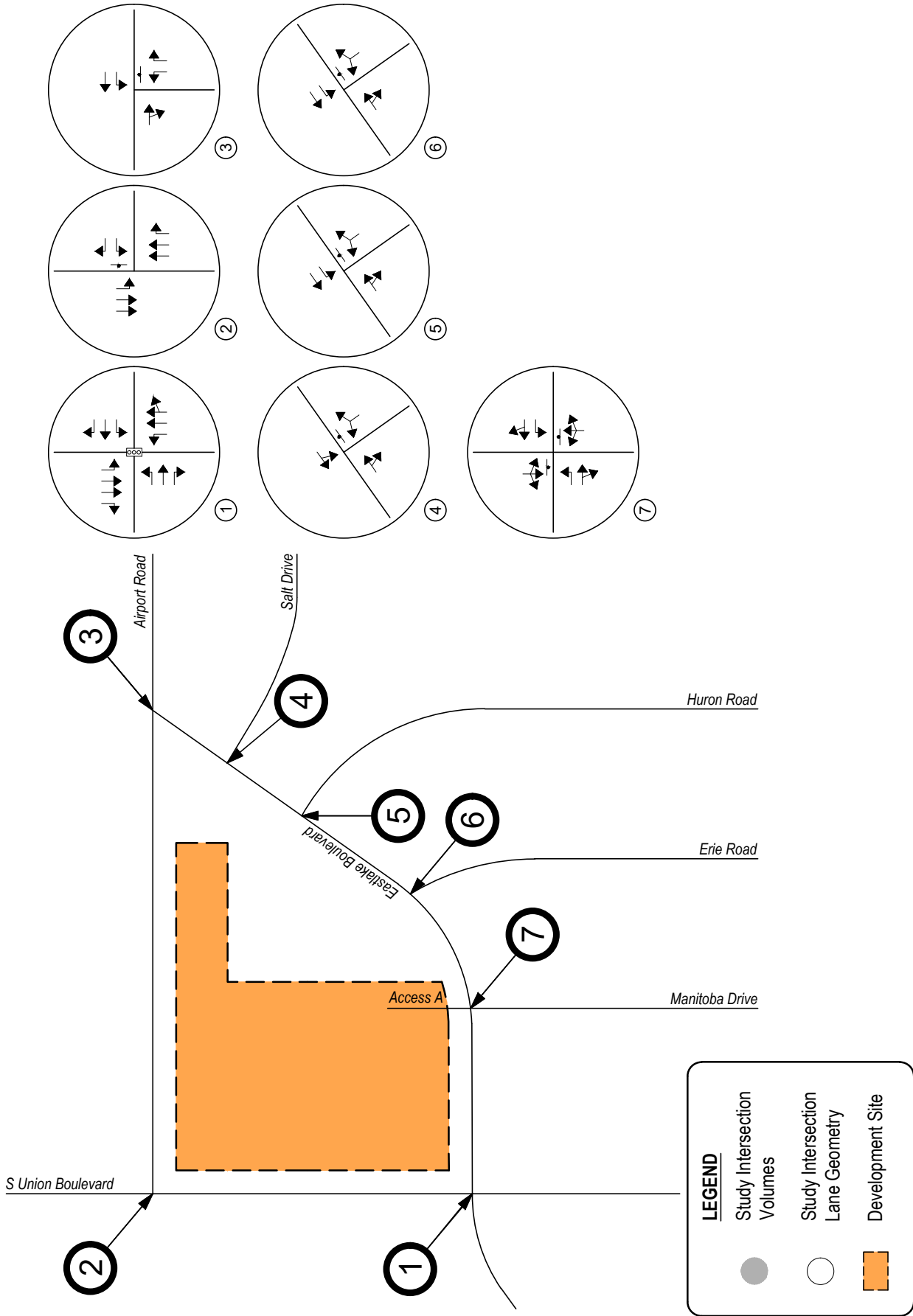

Figure 8
BACKGROUND TRAFFIC - YEAR 2044
Intersection Geometry



Peak Hour Intersection Levels of Service – Background Traffic

As with existing traffic conditions, the operations of study intersections were analyzed under background conditions, without the proposed development, using the SYNCHRO computer program.

Background traffic level of service analysis results for Year 2026 are listed in Table 2. Year 2044 operational results are summarized in Table 3. Definitions of levels of service are given in Appendix D. Intersection capacity worksheets are provided in Appendix E.

Table 2 – Intersection Capacity Analysis Summary – Background Traffic – Year 2026

INTERSECTION LANE GROUPS	LEVEL OF SERVICE	
	AM PEAK HOUR	PM PEAK HOUR
S Union Boulevard / Eastlake Boulevard (Signalized)	A (7.3)	A (7.4)
S Union Boulevard / Airport Road (Stop-Controlled)		
Westbound Left	B	C
Westbound Right	B	A
Southbound Left	A	A
Airport Road / Eastlake Boulevard (Stop-Controlled)		
Westbound Left	A	A
Northbound Left	B	B
Northbound Right	A	A
Eastlake Boulevard / Salt Drive (Stop-Controlled)		
Southwestbound Left and Through	A	A
Northwestbound Left and Right	A	A
Eastlake Boulevard / Huron Road (Stop-Controlled)		
Southwestbound Left	A	A
Northwestbound Left and Right	A	A
Eastlake Boulevard / Erie Road (Stop-Controlled)		
Southwestbound Left	A	A
Northwestbound Left and Right	A	A
Eastlake Boulevard / Manitoba Drive (Stop-Controlled)		
Eastbound Left	A	A
Westbound Left	A	A
Northbound Left, Through, and Right	B	B
Southbound Left, Through, and Right	A	A

Key: Signalized Intersection: Level of Service (Control Delay in sec/v eh)
 Stop-Controlled Intersection: Level of Service

Background Traffic Analysis Results – Year 2026

Year 2026 background traffic analysis indicates that the signalized intersection of S Union Boulevard with Eastlake Boulevard has overall operations at LOS A during the AM and PM peak traffic hours.

All stop-controlled intersections within the study area project turning movement operations at or better than LOS B during the AM peak traffic hour and LOS C or better during the PM peak traffic hour.

Table 3 – Intersection Capacity Analysis Summary – Background Traffic – Year 2044

INTERSECTION LANE GROUPS	LEVEL OF SERVICE	
	AM PEAK HOUR	PM PEAK HOUR
S Union Boulevard / Eastlake Boulevard (Signalized)	A (8.6)	A (8.6)
S Union Boulevard / Airport Road (Stop-Controlled)		
Westbound Left	C	C
Westbound Right	B	B
Southbound Left	A	A
Airport Road / Eastlake Boulevard (Stop-Controlled)		
Westbound Left	A	A
Northbound Left	B	B
Northbound Right	A	B
Eastlake Boulevard / Salt Drive (Stop-Controlled)		
Southwestbound Left and Through	A	A
Northwestbound Left and Right	A	A
Eastlake Boulevard / Huron Road (Stop-Controlled)		
Southwestbound Left	A	A
Northwestbound Left and Right	A	B
Eastlake Boulevard / Erie Road (Stop-Controlled)		
Southwestbound Left	A	A
Northwestbound Left and Right	A	B
Eastlake Boulevard / Manitoba Drive (Stop-Controlled)		
Eastbound Left	A	A
Westbound Left	A	A
Northbound Left, Through, and Right	B	B
Southbound Left, Through, and Right	A	B

Key: Signalized Intersection: Level of Service (Control Delay in sec/veh)
 Stop-Controlled Intersection: Level of Service

Background Traffic Analysis Results – Year 2044

By Year 2044 and without the proposed development, the signalized intersection of S Union Boulevard with Eastlake Boulevard continues to project overall operations at LOS A during the morning and afternoon peak traffic hours.

All stop-controlled intersections within the study area anticipate turning movement operations at or better than LOS C during both peak traffic hours.

IV. Proposed Project Traffic

Trip Generation

Standard traffic generation characteristics compiled by the Institute of Transportation Engineers (ITE) in their report entitled Trip Generation Manual, 11th Edition, were applied to the assumed proposed land uses in order to estimate average daily traffic (ADT), AM Peak Hour, and PM Peak Hour vehicle trips. A vehicle trip is defined as a one-way vehicle movement from a point of origin to a point of destination.

The ITE land use codes 221 (Multifamily Housing (Mid-Rise)), 231 (Mid-Rise Residential with Ground Floor Commercial), 710 (General Office Building), 822 (Strip Retail Plaza (<40k)), and 932 (High-Turnover (Sit-Down) Restaurant) were used for estimating trip generation because of their conservative rates and best fit to the proposed land use descriptions.

It is emphasized that as actual land uses, densities, or site plans within the development area become defined over time, it is expected that traffic generation characteristics considered within this study may need to be updated by more specific traffic analyses or studies to help assess if transportation improvements are needed to mitigate potential traffic impacts.

Trip generation rates used in this study are presented in Table 4.

Table 4 – Trip Generation Rates

ITE CODE	LAND USE	UNIT	TRIP GENERATION RATES								
			24 HOUR	AM PEAK HOUR			PM PEAK HOUR				
				ENTER	EXIT	TOTAL	ENTER	EXIT	TOTAL		
221	Multifamily Housing (Mid-Rise)	DU	4.54	0.09	0.28	0.37	0.24	0.15	0.39		
231	Mid-Rise Residential w/ Ground Floor Commercial	DU	1.70	0.05	0.17	0.22	0.10	0.07	0.17		
710	General Office Building	KSF	10.84	1.34	0.18	1.52	0.24	1.20	1.44		
822	Strip Retail Plaza (<40k)	KSF	54.45	1.42	0.94	2.36	3.30	3.30	6.59		
932	High-Turnover (Sit-Down) Restaurant	KSF	107.20	5.26	4.31	9.57	5.52	3.53	9.05		

Key: DU = Dwelling Unit. KSF = Thousand Square Feet Gross Floor Area.
 Note: All data and calculations above are subject to being rounded to nearest value.

Table 5 illustrates projected ADT, AM Peak Hour, and PM Peak Hour traffic volumes likely generated by the proposed development upon build-out.

Table 5 – Trip Generation Summary

ITE CODE	LAND USE	SIZE	TOTAL TRIPS GENERATED							
			24 HOUR	AM PEAK HOUR			PM PEAK HOUR			
				ENTER	EXIT	TOTAL	ENTER	EXIT	TOTAL	
<u>Site Development - Phase One</u>										
221	Multifamily Housing (Mid-Rise)	73 DU	331	6	21	27	17	11	28	
<i>Phase One Total:</i>			331	6	21	27	17	11	28	
<u>Site Development - Build-Out</u>										
221	Multifamily Housing (Mid-Rise)	30 DU	136	3	9	11	7	5	12	
231	Mid-Rise Residential w/ Ground Floor Commercial	134 DU	228	7	23	29	14	9	23	
710	General Office Building	20.0 KSF	217	27	4	30	5	24	29	
822	Strip Retail Plaza (<40k)	18.0 KSF	980	25	17	42	59	59	119	
932	High-Turnover (Sit-Down) Restaurant	12.0 KSF	1,286	63	52	115	66	42	109	
<i>Build-Out Total:</i>			3,179	131	124	255	169	150	319	

Key: DU = Dwelling Unit, KSF = Thousand Square Feet Gross Floor Area.
 Note: All data and calculations above are subject to being rounded to nearest value.

Upon build-out, Table 5 illustrates that the proposed development has the potential to generate approximately 3,179 daily vehicle trips with 255 of those occurring during the morning peak hour and 319 during the afternoon peak hour.

Adjustments to Trip Generation Rates

It is considered likely that a mixed-use development of this type will attract trips from within area land uses. Utilizing research obtained by the National Cooperative Highway Research Program (NCHRP), ITE created an estimation tool³ for determining internal capture for mixed-use developments. Using NCHRP Report 684 methodology, it was determined that the proposed land uses have various internal capture percentages ranging from 5 to 75 percent. Applying vehicle occupancy estimates from ITE’s Trip Generation Handbook, 3rd Edition, it is determined that overall averages of approximately 21% of total AM peak hour trips and approximately 47% of total PM peak hour trips will be captured internally.

ITE’s internal capture spreadsheets are provided for reference in Appendix C.

Table 6 illustrates projected ADT, AM Peak Hour, and PM Peak Hour traffic volumes likely generated by the proposed development upon build-out with reductions applied due to internal capture.

³ NCHRP Report 684: Enhancing Internal Trip Capture Estimation for Mixed-Use Developments, National Cooperative Highway Research Program, October 2010.

Table 6 – Trip Generation Summary with Reductions

ITE CODE	LAND USE	SIZE	TOTAL NEW TRIPS GENERATED							
			24 HOUR	AM PEAK HOUR			PM PEAK HOUR			
				ENTER	EXIT	TOTAL	ENTER	EXIT	TOTAL	
<u>Site Development - Phase One</u>										
<i>Internal Capture Trip Reduction:</i>			0%	0%	0%	0%	0%	0%	0%	0%
221	Multifamily Housing (Mid-Rise)	73 DU	331	6	21	27	17	11	28	
<i>Phase One Reduced Total:</i>			331	6	21	27	17	11	28	
<u>Site Development - Build-Out</u>										
<i>Internal Capture Trip Reduction:</i>			31%	5%	23%	14%	50%	45%	48%	
221	Multifamily Housing (Mid-Rise)	30 DU	94	2	7	10	4	3	6	
<i>Internal Capture Trip Reduction:</i>			31%	5%	23%	14%	50%	45%	48%	
231	Mid-Rise Residential w/ Ground Floor Commercial	134 DU	158	6	17	25	7	5	12	
<i>Internal Capture Trip Reduction:</i>			43%	20%	75%	48%	50%	26%	38%	
710	General Office Building	20.0 KSF	124	21	1	16	2	18	18	
<i>Internal Capture Trip Reduction:</i>			34%	16%	18%	17%	47%	56%	52%	
822	Strip Retail Plaza (<40k)	18.0 KSF	644	21	14	35	31	26	58	
<i>Internal Capture Trip Reduction:</i>			34%	25%	13%	19%	38%	60%	49%	
932	High-Turnover (Sit-Down) Restaurant	12.0 KSF	849	47	45	93	41	17	55	
<i>Build-Out Reduced Total:</i>			2,201	105	105	210	103	79	182	

Key: DU = Dwelling Unit, KSF = Thousand Square Feet Gross Floor Area.
 Note: All data and calculations above are subject to being rounded to nearest value.

Upon build-out and with consideration for internal capture trip reductions, Table 6 illustrates that the proposed development has the potential to generate approximately 2,201 daily trips with 210 of those occurring during the morning peak hour and 182 during the afternoon peak hour.

Trip Distribution

The overall directional distribution of site-generated traffic was determined based on the location of development site within the City, proposed and existing area land uses, allowed turning movements, available roadway network, and in reference to historical traffic count data provided by CDOT’s Traffic Count Database System (TCDS)⁴.

Overall trip distribution patterns for development Phase One and upon build-out of the development are shown on Figure 9 and Figure 10, respectively.

Trip Assignment

Traffic assignment is how generated and distributed vehicle trips are expected to be loaded onto the available roadway network.

Applying trip distribution patterns to site-generated traffic provides the overall site-generated trip assignments for Phase One and development build-out on Figure 9 and Figure 10, respectively.

⁴ Transportation Data Management System, MS2, 2022.



North

Not to Scale

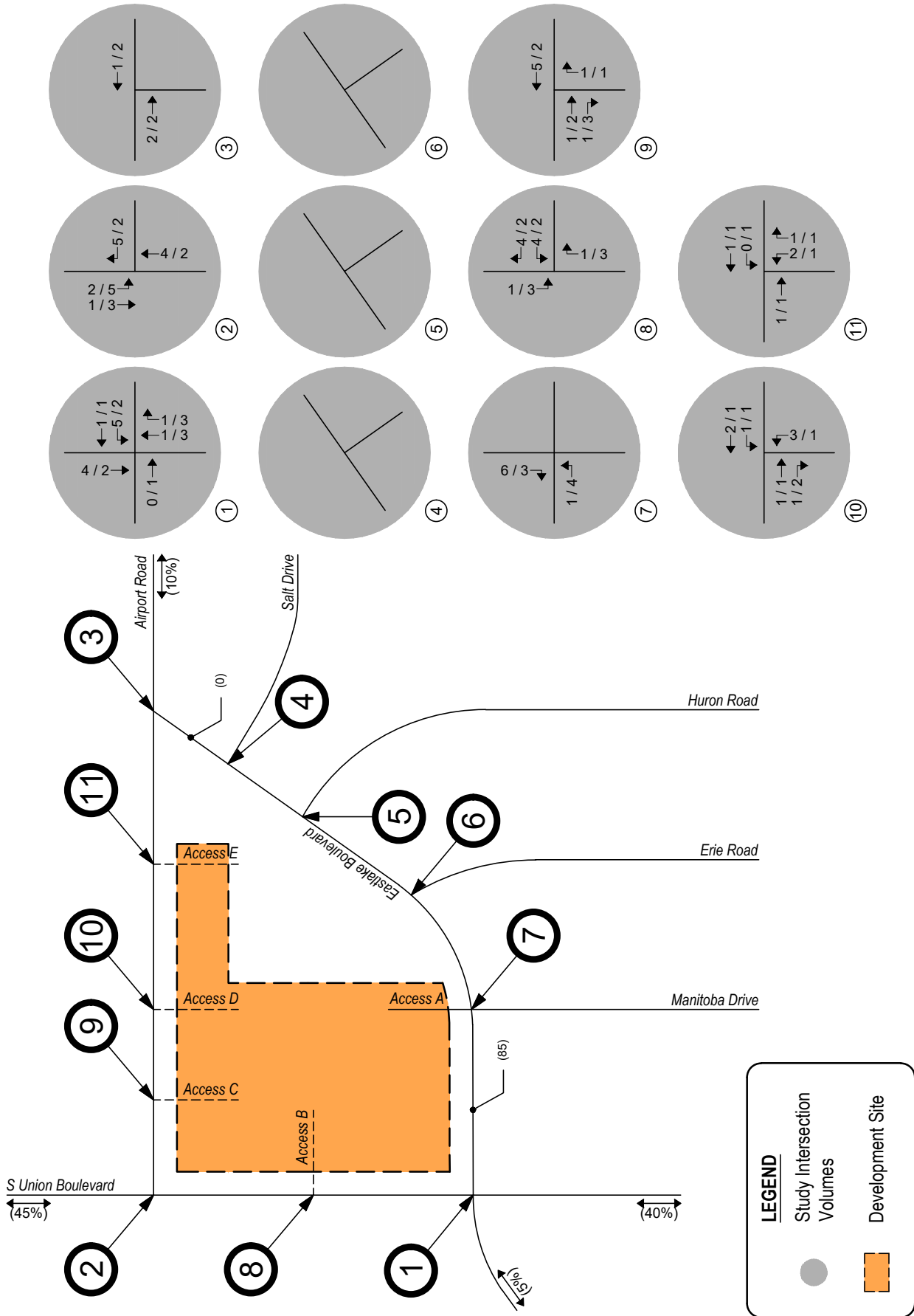

Figure 9
SITE DEVELOPMENT DISTRIBUTION - PHASE ONE
 (%): Overall
SITE-GENERATED TRIPS
 AM / PM Peak Hour

DREAM CENTERS CAMPUS
 Traffic Impact Study

SM ROCHA, LLC
 Traffic and Transportation Consultants





North

Not to Scale

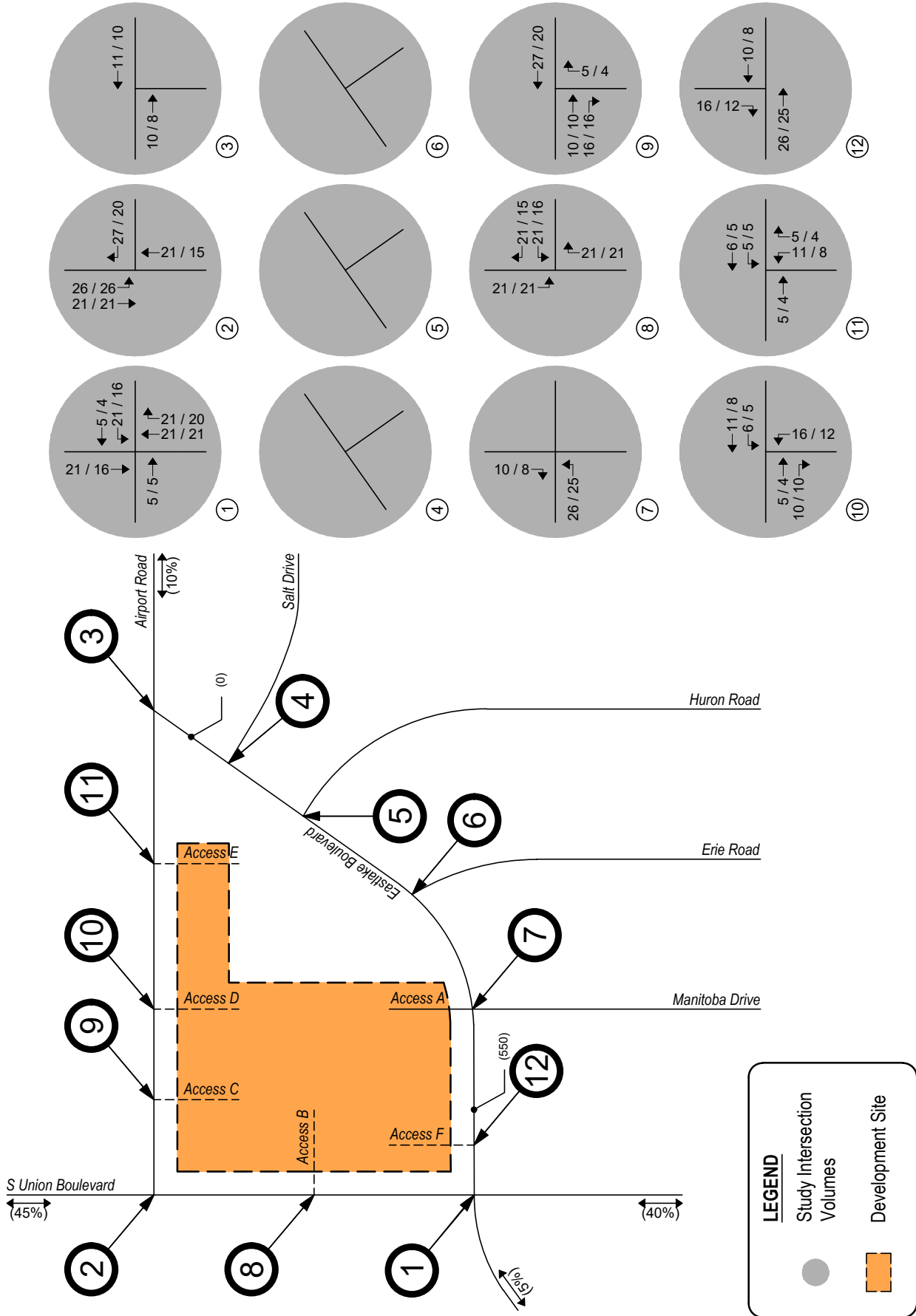

Figure 10
SITE DEVELOPMENT DISTRIBUTION - BUILD-OUT
 (%): Overall
SITE-GENERATED TRIPS
 AM / PM Peak Hour



V. Future Traffic Conditions With Proposed Developments

Total traffic is the traffic projected to be on area roadways with consideration of the proposed development. Total traffic includes background traffic projections for Years 2026 and 2044 with consideration of site-generated traffic. For analysis purposes, it was assumed that development construction would be phased. Phase One is understood to be completed by Year 2026, while Phase Two (build-out) is assumed to be completed by Year 2044.

Pursuant to area roadway improvement discussions provided in Section III, Year 2026 and Year 2044 total traffic conditions assume no roadway improvements to accommodate regional transportation demands. Roadway improvements associated with site development are expected to be limited to site access and frontage as required by the governing agency.

Projected Year 2026 total traffic volumes and intersection geometry are shown in Figure 11 and Figure 12, respectively.

Figure 13 and Figure 14 shows projected total traffic volumes and intersection geometry for Year 2044, respectively.



Not to Scale

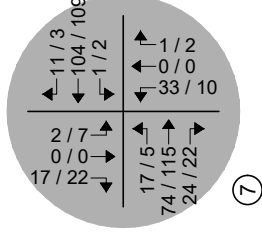
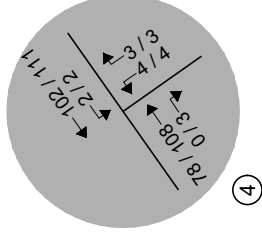
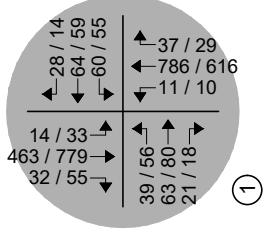
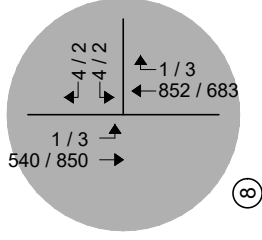
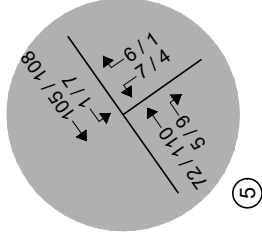
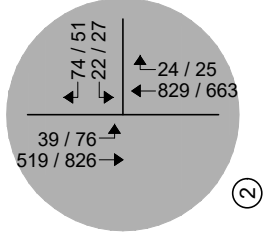
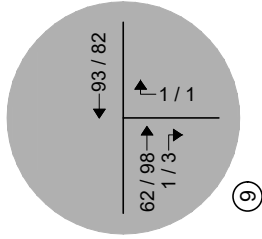
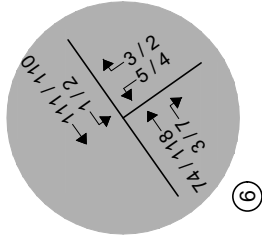
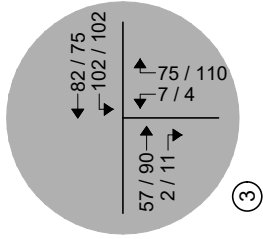
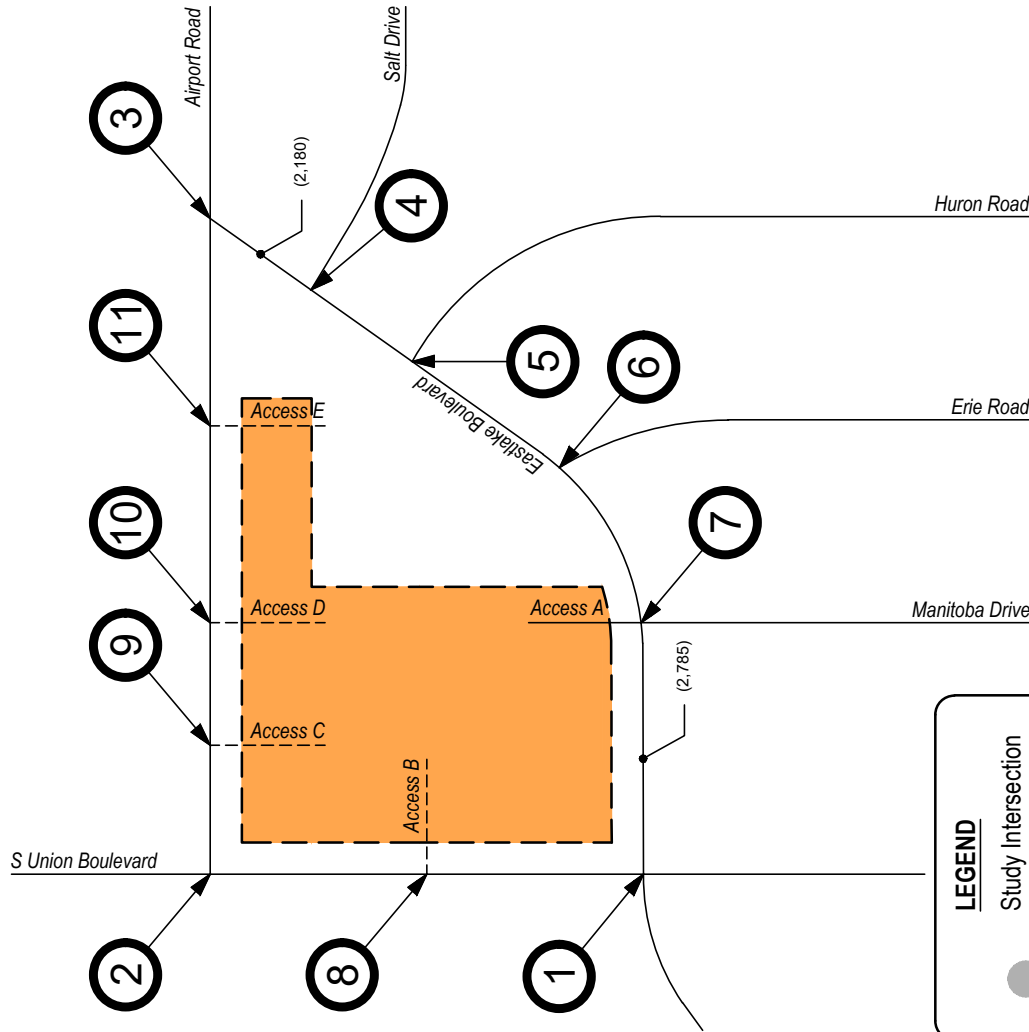

LEGEND

- Study Intersection Volumes
- Study Intersection Lane Geometry
- Development Site

Figure 11
TOTAL TRAFFIC - YEAR 2026
 Volumes
 AM / PM Peak Hour
 (ADT) : Average Daily Traffic

DREAM CENTERS CAMPUS
 Traffic Impact Study



SM ROCHA, LLC
 Traffic and Transportation Consultants

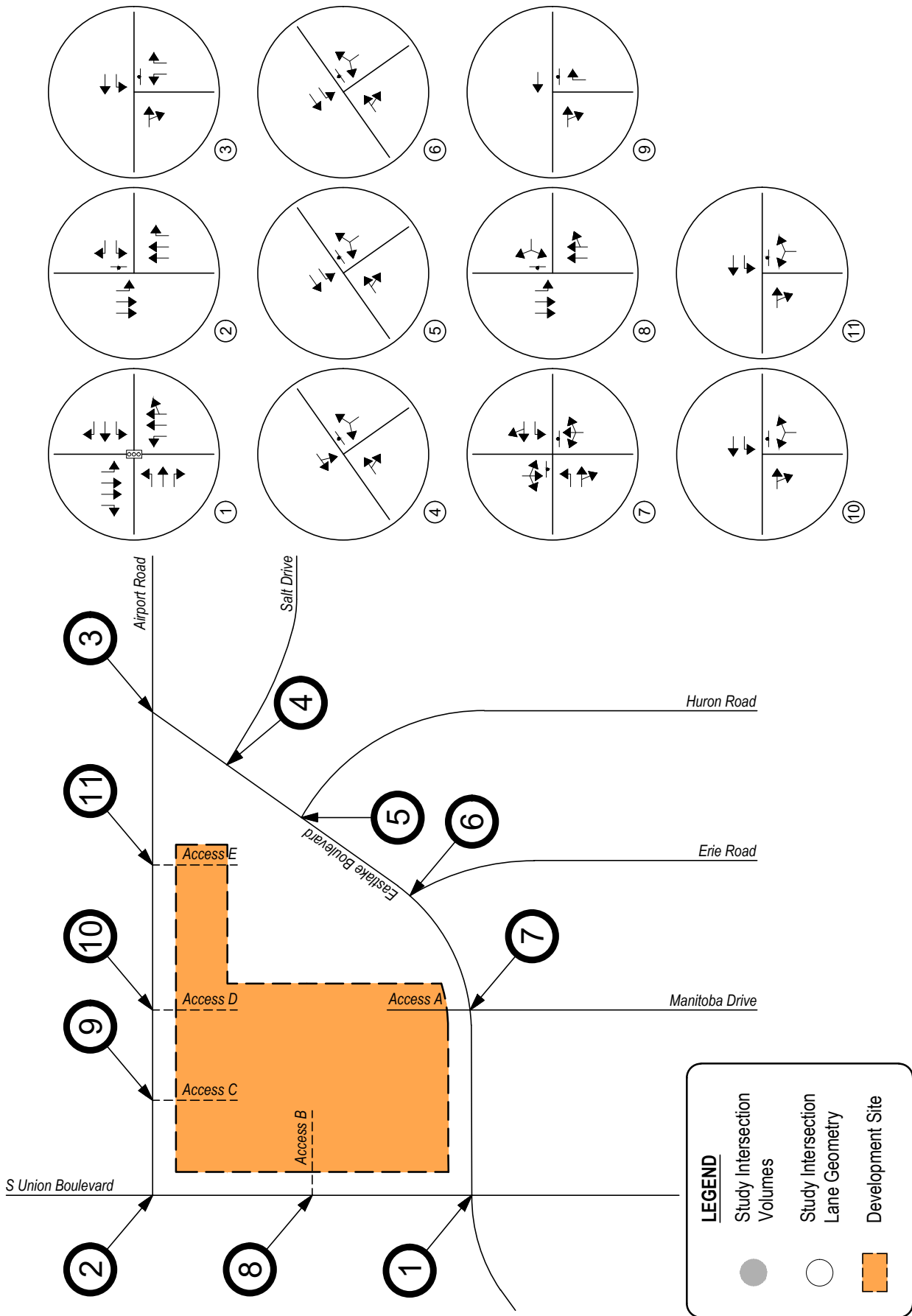
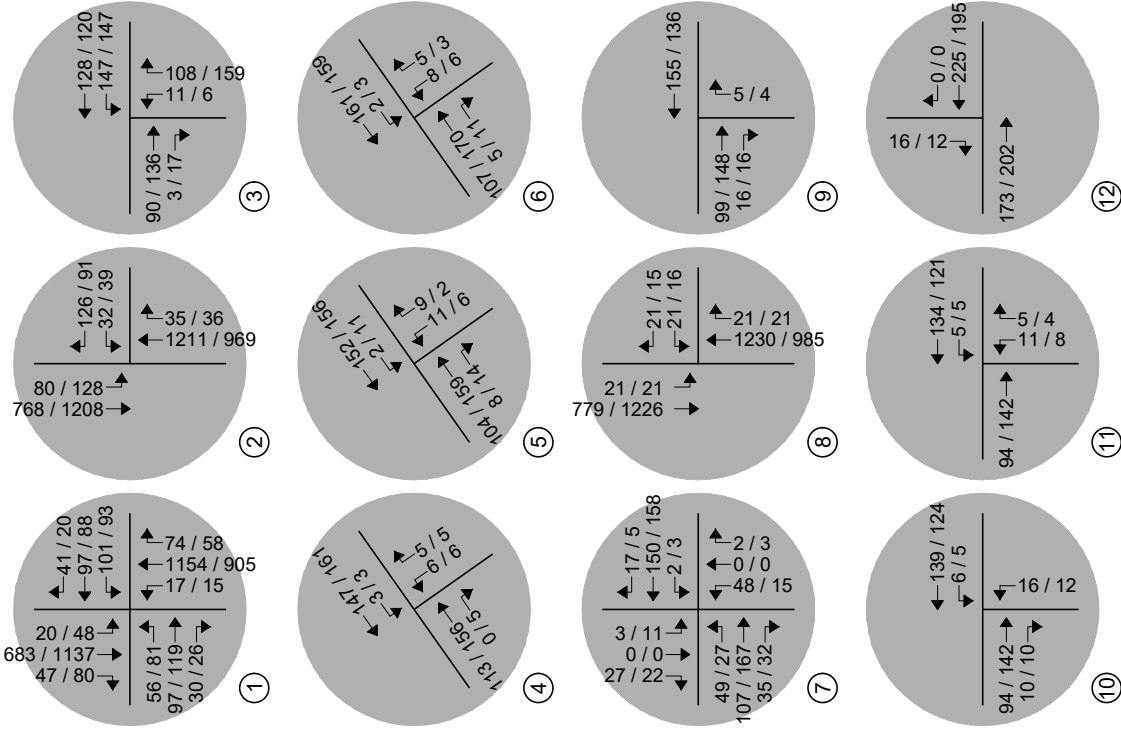
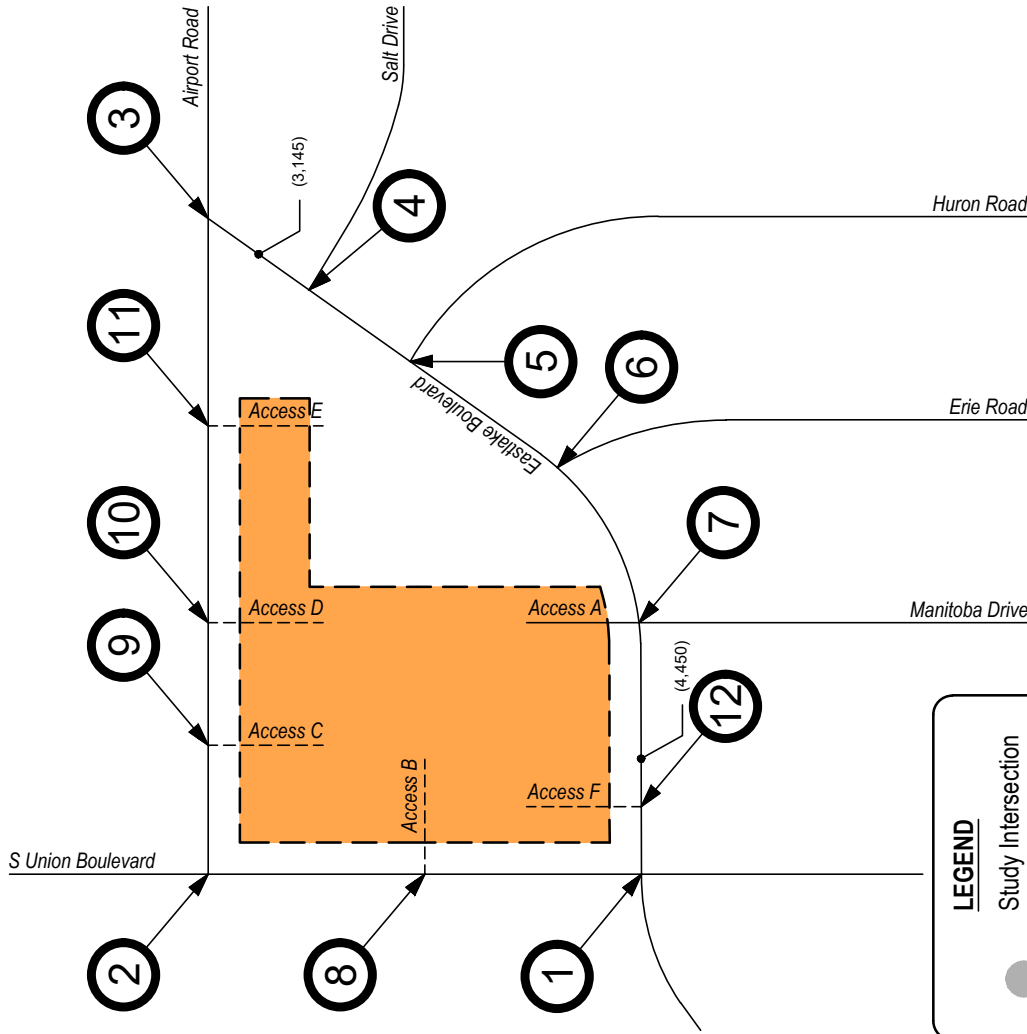

Figure 12
TOTAL TRAFFIC - YEAR 2026
Intersection Geometry



Not to Scale



LEGEND

- Study Intersection
- Volumes
- Study Intersection Lane Geometry
- Development Site

Figure 13
TOTAL TRAFFIC - YEAR 2044
 Volumes
 AM / PM Peak Hour
 (ADT) : Average Daily Traffic

DREAM CENTERS CAMPUS
 Traffic Impact Study

SM ROCHA, LLC
 Traffic and Transportation Consultants



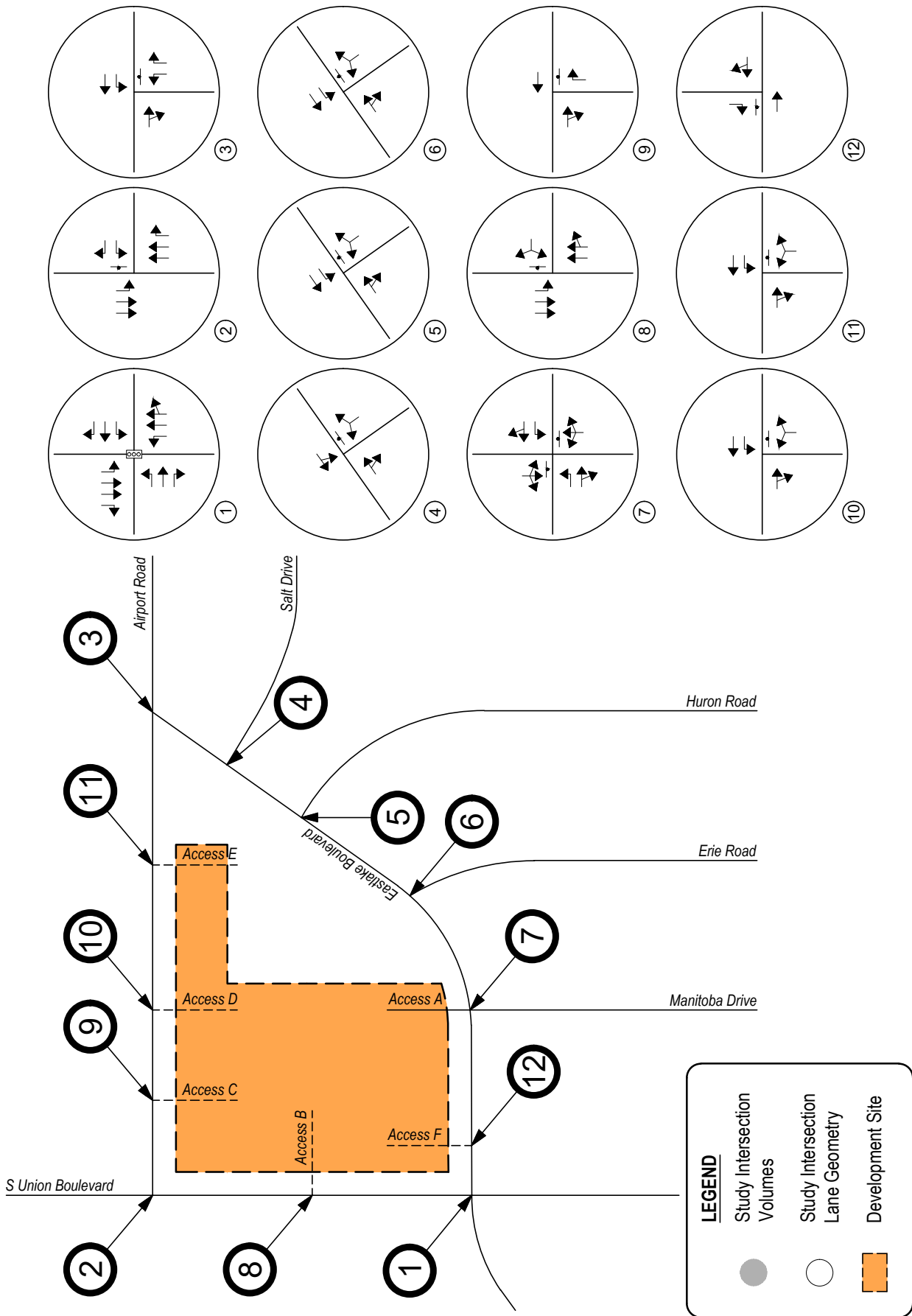

Figure 14
TOTAL TRAFFIC - YEAR 2044
Intersection Geometry



VI. Project Impacts

The analyses and procedures described in this study were performed in accordance with the latest HCM and are based upon the worst-case conditions that occur during a typical weekday upon build-out of site development and analyzed land uses. Therefore, study intersections are likely to operate with traffic conditions better than those described within this study, which represent the peak hours of weekday operations only.

Peak Hour Intersection Levels of Service – Total Traffic

As with background traffic, the operations of the study intersections were analyzed under projected total traffic conditions using the SYNCHRO computer program. Total traffic level of service analysis results for Years 2026 and 2044 are summarized in Table 7 and Table 8, respectively.

Definitions of levels of service are given in Appendix D. Intersection capacity worksheets are provided in Appendix E.

Table 7 – Intersection Capacity Analysis Summary – Total Traffic – Year 2026

INTERSECTION LANE GROUPS	LEVEL OF SERVICE	
	AM PEAK HOUR	PM PEAK HOUR
S Union Boulevard / Eastlake Boulevard (Signalized)	A (7.4)	A (7.4)
S Union Boulevard / Airport Road (Stop-Controlled)		
Westbound Left	B	C
Westbound Right	B	A
Southbound Left	A	A
Airport Road / Eastlake Boulevard (Stop-Controlled)		
Westbound Left	A	A
Northbound Left	B	B
Northbound Right	A	A
Eastlake Boulevard / Salt Drive (Stop-Controlled)		
Southwestbound Left and Through	A	A
Northwestbound Left and Right	A	A
Eastlake Boulevard / Huron Road (Stop-Controlled)		
Southwestbound Left	A	A
Northwestbound Left and Right	A	A
Eastlake Boulevard / Erie Road (Stop-Controlled)		
Southwestbound Left	A	A
Northwestbound Left and Right	A	A
Eastlake Boulevard / Manitoba Drive / Access A (Stop-Controlled)		
Eastbound Left	A	A
Westbound Left	A	A
Northbound Left, Through, and Right	B	B
Southbound Left, Through, and Right	A	A
Access B / S Union Boulevard (Stop-Controlled)		
Westbound Left and Right	C	B
Southbound Left	A	A
Access C / Airport Road (Stop-Controlled)		
Northbound Right	A	A
Access D / Airport Road (Stop-Controlled)		
Westbound Left	A	A
Northbound Left and Right	A	A
Access E / Airport Road (Stop-Controlled)		
Westbound Left	A	A
Northbound Left and Right	A	A

Key: Signalized Intersection: Level of Service (Control Delay in sec/veh)
 Stop-Controlled Intersection: Level of Service

Table 8 – Intersection Capacity Analysis Summary – Total Traffic – Year 2044

INTERSECTION LANE GROUPS	LEVEL OF SERVICE	
	AM PEAK HOUR	PM PEAK HOUR
S Union Boulevard / Eastlake Boulevard (Signalized)	A (9.2)	A (9.0)
S Union Boulevard / Airport Road (Stop-Controlled)		
Westbound Left	C	D
Westbound Right	B	B
Southbound Left	A	A
Airport Road / Eastlake Boulevard (Stop-Controlled)		
Westbound Left	A	A
Northbound Left	B	B
Northbound Right	A	B
Eastlake Boulevard / Salt Drive (Stop-Controlled)		
Southwestbound Left and Through	A	A
Northwestbound Left and Right	A	A
Eastlake Boulevard / Huron Road (Stop-Controlled)		
Southwestbound Left	A	A
Northwestbound Left and Right	A	B
Eastlake Boulevard / Erie Road (Stop-Controlled)		
Southwestbound Left	A	A
Northwestbound Left and Right	A	B
Eastlake Boulevard / Manitoba Drive / Access A (Stop-Controlled)		
Eastbound Left	A	A
Westbound Left	A	A
Northbound Left, Through, and Right	B	B
Southbound Left, Through, and Right	A	B
Access B / S Union Boulevard (Stop-Controlled)		
Westbound Left and Right	C	C
Southbound Left	B	B
Access C / Airport Road (Stop-Controlled)		
Northbound Right	A	A
Access D / Airport Road (Stop-Controlled)		
Westbound Left	A	A
Northbound Left and Right	B	B
Access E / Airport Road (Stop-Controlled)		
Westbound Left	A	A
Northbound Left and Right	A	A
Access F / Eastlake Boulevard (Stop-Controlled)		
Southbound Right	A	A

Key: Signalized Intersection: Level of Service (Control Delay in sec/veh)
 Stop-Controlled Intersection: Level of Service

Total Traffic Analysis Results Upon Development Build-Out

Table 8 illustrates how, by Year 2044 and upon development build-out, the signalized intersection of S Union Boulevard with Eastlake Boulevard continues to project overall operations at LOS A during the morning and afternoon peak traffic hours.

The stop-controlled intersection of S Union Boulevard with Airport Road has turn movement operations at or better than LOS C during the morning peak traffic hour and LOS D or better during the afternoon peak traffic hour.

The stop-controlled intersection of Eastlake Boulevard with Airport Road expects turn movement operations at or better than LOS B during both peak traffic hours.

The stop-controlled intersection of Eastlake Boulevard with Salt Drive expects turn movement operations at LOS A during both peak traffic hours.

The stop-controlled intersection of Eastlake Boulevard with Huron Road expects turn movement operations at LOS A during the AM peak traffic hour and LOS B or better during the PM peak traffic hour.

The stop-controlled intersection of Eastlake Boulevard with Erie Road expects turn movement operations at LOS A during the AM peak traffic hour and LOS B or better during the PM peak traffic hour.

The stop-controlled intersection of Eastlake Boulevard with Manitoba Drive and Access A expects turn movement operations at or better than LOS B during both peak traffic hours.

The stop-controlled intersection of Access B with S Union Boulevard expects turn movement operations at or better than LOS C during both peak traffic hours.

The stop-controlled intersection of Access C with Airport Road expects turn movement operations at or LOS A during both peak traffic hours.

The stop-controlled intersection of Access D with Airport Road expects turn movement operations at LOS B or better during both peak traffic hours.

The stop-controlled intersection of Access E with Airport Road expects turn movement operations at LOS A during both peak traffic hours.

The stop-controlled intersection of Access F with Eastlake Boulevard expects turn movement operations at LOS A during both peak traffic hours.

Compared to the background traffic analysis, the traffic generated by the proposed development is not expected to significantly change the operations of the study intersections. These intersection operations are similar to background conditions.

Queue Length Analysis

Queue lengths for the study intersections were analyzed using Year 2044 total traffic conditions. The analysis yields estimate of 95th percentile queue lengths, which have only a five percent probability of being exceeded during the analysis time period. Queue lengths were modeled and are included with the Synchro worksheets in Appendix E.

No significant queues at the study intersections were indicated. The greatest queue length anticipated at S Union Boulevard and Eastlake Boulevard occurs during the morning peak hour. The queue length is approximately three to four vehicles for the westbound left turn movement. No significant queues are anticipated at the other study intersections.

Recommended Improvements

Roadway and intersection improvement recommendations were assessed pursuant to roadway descriptions discussed in Section I, projected peak hour traffic volumes, level of service results, projected 95th percentile queue lengths, and per requirements defined within the City's Traffic Criteria Manual.

Per the analysis performed within this study, it is concluded that no improvements to the study intersections nor the existing or future roadway network are recommended upon build-out of this development.

VII. Conclusion

This traffic impact study addressed the capacity, geometric, and control requirements associated with the development entitled Dream Centers Campus. This proposed mixed-use development consists of multifamily housing, an office building, general retail space, and a sit-down restaurant. The development is located on the southeast corner of S Union Boulevard and Airport Road in Colorado Springs, Colorado.

The study area to be examined in this analysis encompasses the area bounded by S Union Boulevard, Airport Road, and Eastlake Boulevard, and includes the proposed site access drives.

Analysis was conducted for critical AM Peak Hour and PM Peak Hour traffic operations for existing traffic conditions, Year 2026 and Year 2044 background traffic conditions, and Year 2026 and Year 2044 total traffic conditions.

Analysis of existing traffic conditions indicates that the signalized intersection of S Union Boulevard with Eastlake Boulevard has overall operations at LOS A during the morning and afternoon peak traffic hours. All stop-controlled intersections within the study area have turning movement operations at or better than LOS B during the morning peak traffic hour and LOS C or better during the afternoon peak traffic hour.

Without the proposed development, Year 2026 background operational analysis shows that the signalized intersection of S Union Boulevard with Eastlake Boulevard continues to have overall operations at LOS A during the morning and afternoon peak traffic hours. All stop-controlled intersections within the study area continue to have turning movement operations at or better than LOS B during the morning peak traffic hour and LOS C or better during the afternoon peak traffic hour.

By Year 2044 and without the proposed development, the signalized intersection of S Union Boulevard with Eastlake Boulevard continues to project overall operations at LOS A during the morning and afternoon peak traffic hours. All stop-controlled intersections within the study area anticipate turning movement operations at or better than LOS C during both the morning and afternoon peak traffic hours.

Analysis of future traffic conditions indicates that the addition of site-generated traffic is expected to create no negative impact to traffic operations for the existing and surrounding roadway system upon roadway and intersection control improvements assumed within this analysis. With all conservative assumptions defined in this analysis, the study intersections are projected to operate at future levels of service comparable to Year 2044 background traffic conditions. Proposed site accesses have long-term operations at LOS C or better during peak traffic periods and upon build-out.

APPENDIX A

Traffic Count Data

Location: 1 UNION BLVD & AIRPORT ROAD AM

Date: Thursday, January 11, 2024

Peak Hour: 07:30 AM - 08:30 AM

Peak 15-Minutes: 07:45 AM - 08:00 AM

Peak Hour - Motorized Vehicles

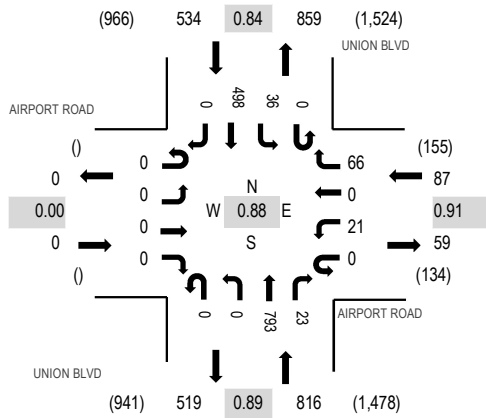

Peak Hour - Bicycles

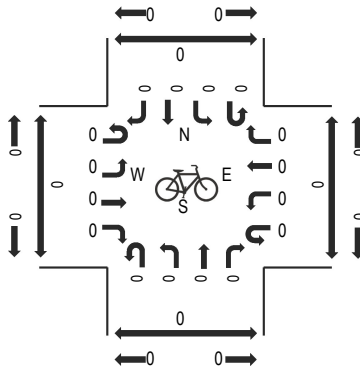

Peak Hour - Pedestrians

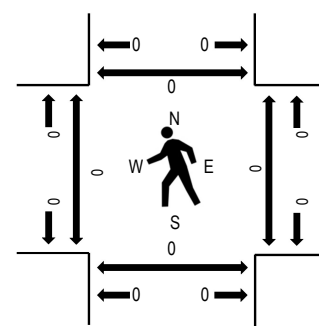

Note: Total study counts contained in parentheses.

Traffic Counts - Motorized Vehicles

Interval Start Time	AIRPORT ROAD Eastbound				AIRPORT ROAD Westbound				UNION BLVD Northbound				UNION BLVD Southbound				Total	Rolling Hour	Pedestrian Crossings			
	U-Turn	Left	Thru	Right	U-Turn	Left	Thru	Right	U-Turn	Left	Thru	Right	U-Turn	Left	Thru	Right			West	East	South	North
7:00 AM	0	0	0	0	0	4	0	13	0	0	125	9	0	7	102	0	260	1,353	1	0	0	0
7:15 AM	0	0	0	0	0	7	0	13	0	0	183	15	0	7	88	0	313	1,408	0	0	0	0
7:30 AM	0	0	0	0	0	5	0	19	0	0	205	7	0	14	123	0	373	1,437	0	0	0	0
7:45 AM	0	0	0	0	0	5	0	13	0	0	222	9	0	10	148	0	407	1,380	0	0	0	0
8:00 AM	0	0	0	0	0	5	0	17	0	0	177	5	0	8	103	0	315	1,246	0	0	0	0
8:15 AM	0	0	0	0	0	6	0	17	0	0	189	2	0	4	124	0	342		0	0	0	0
8:30 AM	0	0	0	0	0	4	0	10	0	0	164	12	0	7	119	0	316		0	0	0	0
8:45 AM	0	0	0	0	0	4	0	13	0	0	144	10	0	8	94	0	273		0	0	0	0
Count Total	0	0	0	0	0	40	0	115	0	0	1,409	69	0	65	901	0	2,599		1	0	0	0
Peak Hour	0	0	0	0	0	21	0	66	0	0	793	23	0	36	498	0	1,437		0	0	0	0

Location: 1 UNION BLVD & AIRPORT ROAD PM

Date: Thursday, January 11, 2024

Peak Hour: 04:00 PM - 05:00 PM

Peak 15-Minutes: 04:00 PM - 04:15 PM

Peak Hour - Motorized Vehicles

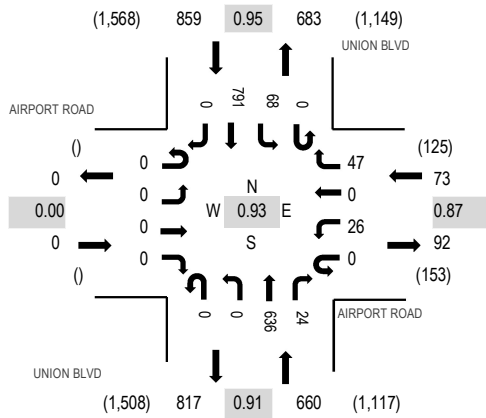

Peak Hour - Bicycles

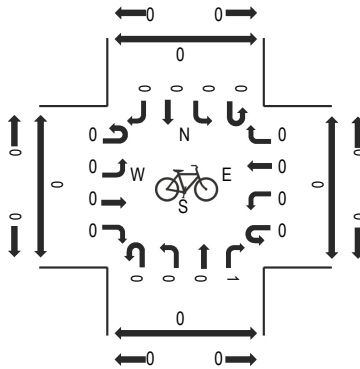

Peak Hour - Pedestrians

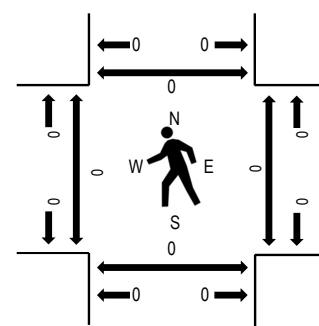

Note: Total study counts contained in parentheses.

Traffic Counts - Motorized Vehicles

Interval Start Time	AIRPORT ROAD Eastbound				AIRPORT ROAD Westbound				UNION BLVD Northbound				UNION BLVD Southbound				Total	Rolling Hour	Pedestrian Crossings			
	U-Turn	Left	Thru	Right	U-Turn	Left	Thru	Right	U-Turn	Left	Thru	Right	U-Turn	Left	Thru	Right			West	East	South	North
4:00 PM	0	0	0	0	0	6	0	15	0	0	174	7	0	27	199	0	428	1,592	0	0	0	0
4:15 PM	0	0	0	0	0	8	0	8	0	0	165	10	0	15	207	0	413	1,536	0	0	0	0
4:30 PM	0	0	0	0	0	9	0	10	0	0	167	4	0	13	189	0	392	1,466	0	0	0	0
4:45 PM	0	0	0	0	0	3	0	14	0	0	130	3	0	13	196	0	359	1,346	0	0	0	0
5:00 PM	0	0	0	0	0	6	0	8	0	0	126	6	0	11	215	0	372	1,218	0	0	0	0
5:15 PM	0	0	0	0	0	5	0	10	0	0	122	5	0	11	190	0	343		0	2	0	0
5:30 PM	0	0	0	0	0	2	0	8	0	0	97	10	1	9	145	0	272		0	0	0	0
5:45 PM	0	0	0	0	0	6	0	7	0	0	87	4	0	5	122	0	231		0	0	0	0
Count Total	0	0	0	0	0	45	0	80	0	0	1,068	49	1	104	1,463	0	2,810		0	2	0	0
Peak Hour	0	0	0	0	0	26	0	47	0	0	636	24	0	68	791	0	1,592		0	0	0	0

Location: 2 UNION BLVD & EASTLAKE BLVD AM

Date: Thursday, January 11, 2024

Peak Hour: 07:15 AM - 08:15 AM

Peak 15-Minutes: 07:45 AM - 08:00 AM

Peak Hour - Motorized Vehicles

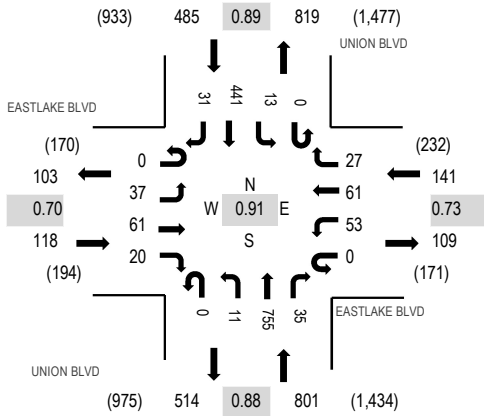

Peak Hour - Bicycles

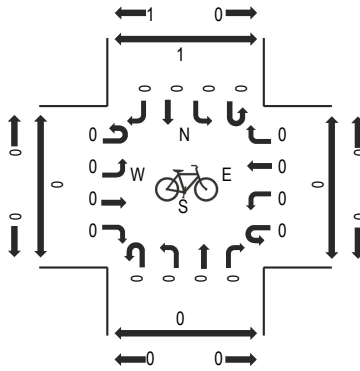

Peak Hour - Pedestrians

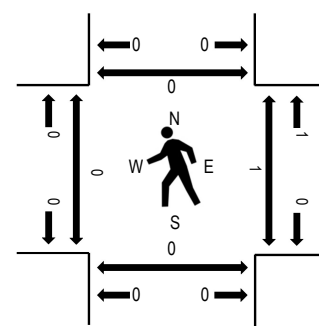

Note: Total study counts contained in parentheses.

Traffic Counts - Motorized Vehicles

Interval Start Time	EASTLAKE BLVD Eastbound				EASTLAKE BLVD Westbound				UNION BLVD Northbound				UNION BLVD Southbound				Total	Rolling Hour	Pedestrian Crossings			
	U-Turn	Left	Thru	Right	U-Turn	Left	Thru	Right	U-Turn	Left	Thru	Right	U-Turn	Left	Thru	Right			West	East	South	North
7:00 AM	0	6	8	2	0	13	10	0	0	0	128	3	0	2	98	6	276	1,472	0	0	0	0
7:15 AM	0	9	17	7	0	12	15	6	0	1	184	7	0	1	89	6	354	1,545	0	0	0	0
7:30 AM	0	8	25	9	0	18	21	9	0	4	193	4	0	2	120	5	418	1,545	0	0	0	0
7:45 AM	0	11	11	2	0	9	16	3	0	1	213	13	0	6	125	14	424	1,460	0	0	0	0
8:00 AM	0	9	8	2	0	14	9	9	0	5	165	11	0	4	107	6	349	1,321	0	1	0	0
8:15 AM	0	10	7	1	0	9	9	4	0	4	180	5	0	5	112	8	354		0	0	0	0
8:30 AM	0	14	4	0	0	16	7	3	0	1	157	3	0	4	112	12	333		0	0	0	0
8:45 AM	0	8	11	5	0	12	6	2	0	0	146	6	0	4	81	4	285		0	0	0	0
Count Total	0	75	91	28	0	103	93	36	0	16	1,366	52	0	28	844	61	2,793		0	1	0	0
Peak Hour	0	37	61	20	0	53	61	27	0	11	755	35	0	13	441	31	1,545		0	1	0	0

Peak Hour - Motorized Vehicles

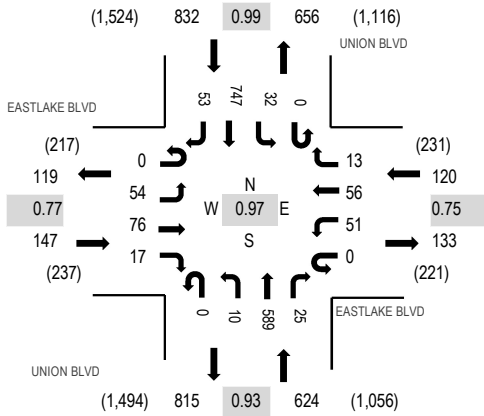

Peak Hour - Bicycles

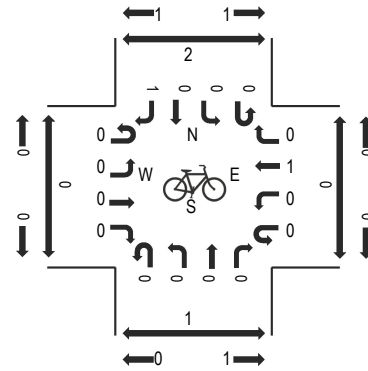

Peak Hour - Pedestrians

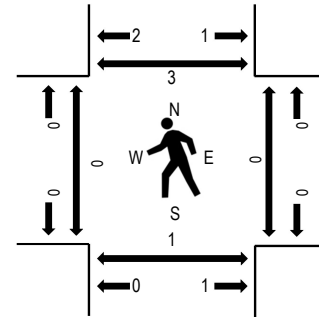

Note: Total study counts contained in parentheses.

Traffic Counts - Motorized Vehicles

Interval Start Time	EASTLAKE BLVD Eastbound				EASTLAKE BLVD Westbound				UNION BLVD Northbound				UNION BLVD Southbound				Total	Rolling Hour	Pedestrian Crossings			
	U-Turn	Left	Thru	Right	U-Turn	Left	Thru	Right	U-Turn	Left	Thru	Right	U-Turn	Left	Thru	Right			West	East	South	North
4:00 PM	0	20	23	5	0	10	10	5	0	4	153	6	0	9	185	15	445	1,723	0	0	0	1
4:15 PM	0	12	17	5	0	8	13	4	0	2	158	7	0	8	187	15	436	1,685	0	0	1	1
4:30 PM	0	11	17	2	0	22	18	4	0	2	157	9	0	6	185	13	446	1,617	0	0	0	0
4:45 PM	0	11	19	5	0	11	15	0	0	2	121	3	0	9	190	10	396	1,454	0	0	0	1
5:00 PM	0	11	17	3	0	17	16	4	0	2	119	8	0	6	191	13	407	1,325	0	0	0	0
5:15 PM	0	10	13	3	0	6	12	3	0	0	115	3	0	7	180	16	368		0	0	0	0
5:30 PM	0	4	8	2	0	3	13	6	0	0	96	2	0	4	136	9	283		0	0	0	0
5:45 PM	0	4	9	6	0	11	14	6	0	0	82	5	0	6	121	3	267		0	0	0	0
Count Total	0	83	123	31	0	88	111	32	0	12	1,001	43	0	55	1,375	94	3,048		0	0	1	3
Peak Hour	0	54	76	17	0	51	56	13	0	10	589	25	0	32	747	53	1,723		0	0	1	3

Location: 3 EASTLAKE BLVD & AIRPORT RD AM

Date: Thursday, January 11, 2024

Peak Hour: 07:15 AM - 08:15 AM

Peak 15-Minutes: 07:30 AM - 07:45 AM

Peak Hour - Motorized Vehicles

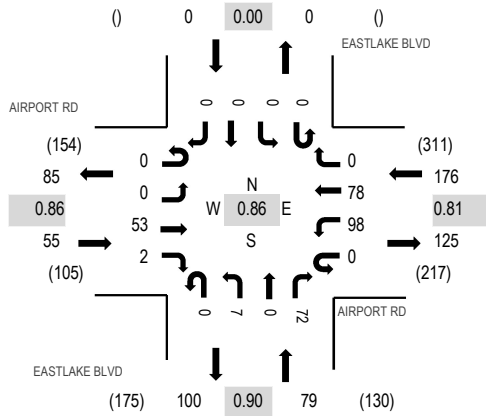

Peak Hour - Bicycles

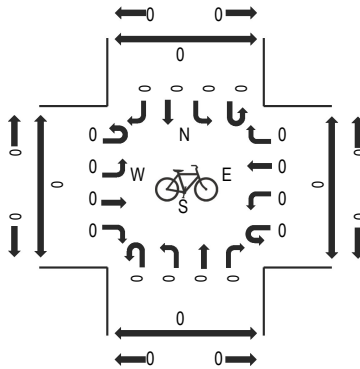

Peak Hour - Pedestrians

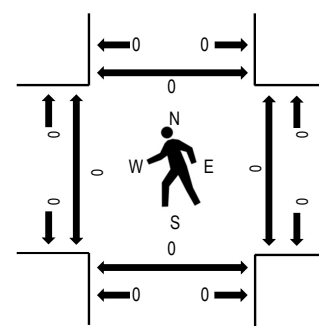

Note: Total study counts contained in parentheses.

Traffic Counts - Motorized Vehicles

Interval Start Time	AIRPORT RD Eastbound				AIRPORT RD Westbound				EASTLAKE BLVD Northbound				EASTLAKE BLVD Southbound				Total	Rolling Hour	Pedestrian Crossings			
	U-Turn	Left	Thru	Right	U-Turn	Left	Thru	Right	U-Turn	Left	Thru	Right	U-Turn	Left	Thru	Right			West	East	South	North
7:00 AM	0	0	8	2	0	19	19	0	0	0	0	11	0	0	0	0	59	295	0	0	0	1
7:15 AM	0	0	11	0	0	24	22	0	0	1	0	19	0	0	0	0	77	310	0	0	0	0
7:30 AM	0	0	15	0	0	28	26	0	0	2	0	19	0	0	0	0	90	284	0	0	0	0
7:45 AM	0	0	16	0	0	24	13	0	0	0	0	16	0	0	0	0	69	258	0	0	0	0
8:00 AM	0	0	11	2	0	22	17	0	0	4	0	18	0	0	0	0	74	251	0	0	0	0
8:15 AM	0	0	6	0	0	14	19	0	0	1	0	11	0	0	0	0	51		0	0	0	0
8:30 AM	0	0	14	3	0	20	17	0	0	0	0	10	0	0	0	0	64		0	0	0	0
8:45 AM	1	0	15	1	0	16	11	0	0	1	0	17	0	0	0	0	62		0	0	0	0
Count Total	1	0	96	8	0	167	144	0	0	9	0	121	0	0	0	0	546		0	0	0	1
Peak Hour	0	0	53	2	0	98	78	0	0	7	0	72	0	0	0	0	310		0	0	0	0

Location: 3 EASTLAKE BLVD & AIRPORT RD PM

Date: Thursday, January 11, 2024

Peak Hour: 04:00 PM - 05:00 PM

Peak 15-Minutes: 04:00 PM - 04:15 PM

Peak Hour - Motorized Vehicles

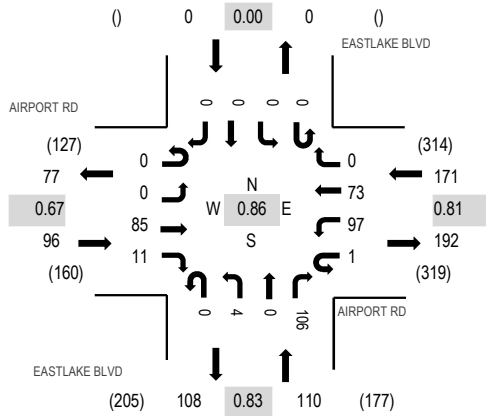

Peak Hour - Bicycles

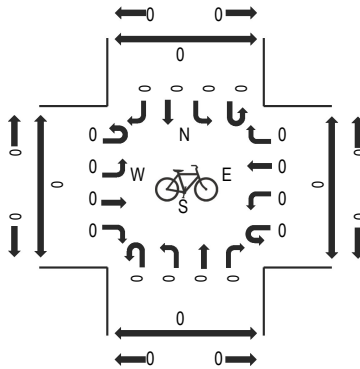

Peak Hour - Pedestrians

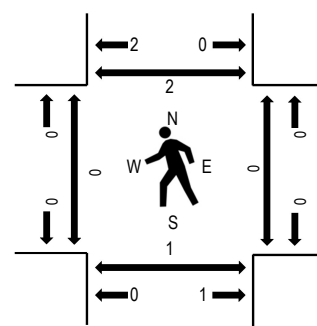

Note: Total study counts contained in parentheses.

Traffic Counts - Motorized Vehicles

Interval Start Time	AIRPORT RD Eastbound				AIRPORT RD Westbound				EASTLAKE BLVD Northbound				EASTLAKE BLVD Southbound				Total	Rolling Hour	Pedestrian Crossings			
	U-Turn	Left	Thru	Right	U-Turn	Left	Thru	Right	U-Turn	Left	Thru	Right	U-Turn	Left	Thru	Right			West	East	South	North
4:00 PM	0	0	35	1	0	23	17	0	0	2	0	31	0	0	0	0	109	377	0	0	0	0
4:15 PM	0	0	20	1	0	24	13	0	0	2	0	20	0	0	0	0	80	351	0	0	0	0
4:30 PM	0	0	16	8	0	28	26	0	0	0	0	27	0	0	0	0	105	344	0	0	1	0
4:45 PM	0	0	14	1	1	22	17	0	0	0	0	28	0	0	0	0	83	295	0	0	0	2
5:00 PM	0	0	16	0	0	33	12	0	0	1	0	21	0	0	0	0	83	274	0	0	0	0
5:15 PM	0	0	19	1	0	19	14	0	0	1	0	19	0	0	0	0	73		0	0	0	0
5:30 PM	0	0	18	0	0	18	9	0	0	0	0	11	0	0	0	0	56		0	0	0	0
5:45 PM	0	0	9	1	0	25	13	0	0	0	0	14	0	0	0	0	62		0	0	0	0
Count Total	0	0	147	13	1	192	121	0	0	6	0	171	0	0	0	0	651		0	0	1	2
Peak Hour	0	0	85	11	1	97	73	0	0	4	0	106	0	0	0	0	377		0	0	1	2

Peak Hour - Motorized Vehicles

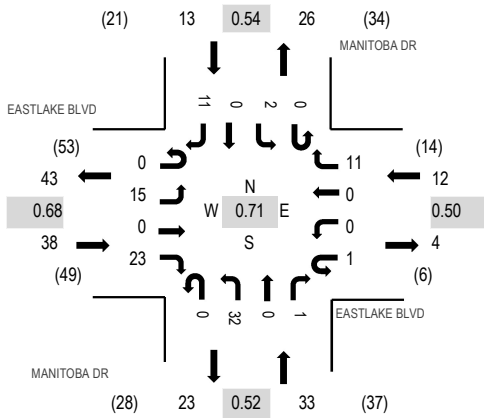

Peak Hour - Bicycles

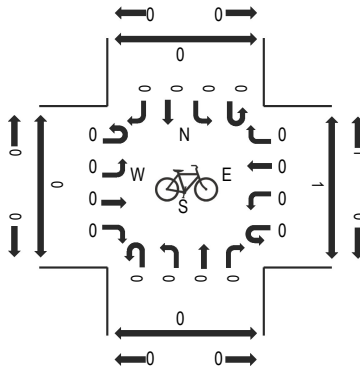

Peak Hour - Pedestrians

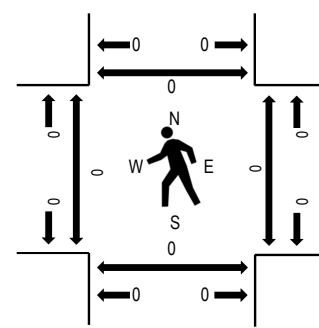

Note: Total study counts contained in parentheses.

Traffic Counts - Motorized Vehicles

Interval Start Time	EASTLAKE BLVD Eastbound				EASTLAKE BLVD Westbound				MANITOBA DR Northbound				MANITOBA DR Southbound				Total	Rolling Hour	Pedestrian Crossings			
	U-Turn	Left	Thru	Right	U-Turn	Left	Thru	Right	U-Turn	Left	Thru	Right	U-Turn	Left	Thru	Right			West	East	South	North
7:00 AM	0	0	0	2	0	0	0	1	0	1	0	0	0	0	0	0	4	73	0	0	0	0
7:15 AM	0	2	0	5	0	0	0	1	0	9	0	0	0	0	0	2	19	96	0	0	0	0
7:30 AM	0	1	0	13	0	0	0	2	0	15	0	1	0	0	0	2	34	86	0	0	0	0
7:45 AM	0	4	0	3	0	0	0	3	0	4	0	0	0	1	0	1	16	57	0	0	0	0
8:00 AM	0	8	0	2	1	0	0	5	0	4	0	0	0	1	0	6	27	48	0	0	0	0
8:15 AM	0	3	0	2	0	0	0	0	0	0	0	0	0	0	0	4	9		0	0	0	1
8:30 AM	0	1	0	1	0	0	0	0	0	2	0	0	0	0	0	1	5		0	0	0	0
8:45 AM	0	2	0	0	0	0	0	1	0	1	0	0	0	2	0	1	7		0	0	0	0
Count Total	0	21	0	28	1	0	0	13	0	36	0	1	0	4	0	17	121		0	0	0	1
Peak Hour	0	15	0	23	1	0	0	11	0	32	0	1	0	2	0	11	96		0	0	0	0

Location: 4 MANITOBA DR & EASTLAKE BLVD PM

Date: Thursday, January 11, 2024

Peak Hour: 04:00 PM - 05:00 PM

Peak 15-Minutes: 04:30 PM - 04:45 PM

Peak Hour - Motorized Vehicles

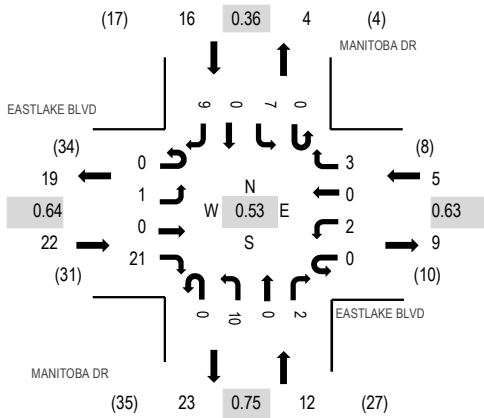

Peak Hour - Bicycles

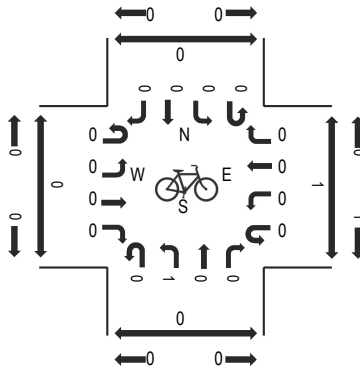

Peak Hour - Pedestrians

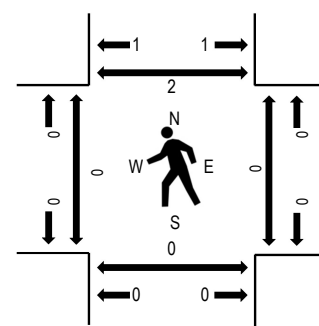

Note: Total study counts contained in parentheses.

Traffic Counts - Motorized Vehicles

Interval Start Time	EASTLAKE BLVD Eastbound				EASTLAKE BLVD Westbound				MANITOBA DR Northbound				MANITOBA DR Southbound				Total	Rolling Hour	Pedestrian Crossings			
	U-Turn	Left	Thru	Right	U-Turn	Left	Thru	Right	U-Turn	Left	Thru	Right	U-Turn	Left	Thru	Right			West	East	South	North
4:00 PM	0	1	0	3	0	0	0	2	0	2	0	0	0	1	0	3	12	55	0	0	0	0
4:15 PM	0	0	0	7	0	1	0	0	0	2	0	0	0	0	0	0	10	52	0	0	0	1
4:30 PM	0	0	0	9	0	1	0	0	0	4	0	1	0	6	0	5	26	46	0	0	0	0
4:45 PM	0	0	0	2	0	0	0	1	0	2	0	1	0	0	0	1	7	28	0	0	0	1
5:00 PM	0	0	0	5	0	1	0	0	0	3	0	0	0	0	0	0	9	28	0	0	0	0
5:15 PM	0	0	0	0	0	1	0	0	0	3	0	0	0	0	0	0	4		0	0	0	2
5:30 PM	0	0	0	2	0	1	0	0	0	4	0	0	0	1	0	0	8		0	0	0	0
5:45 PM	0	0	0	2	0	0	0	0	0	5	0	0	0	0	0	0	7		0	0	0	0
Count Total	0	1	0	30	0	5	0	3	0	25	0	2	0	8	0	9	83		0	0	0	4
Peak Hour	0	1	0	21	0	2	0	3	0	10	0	2	0	7	0	9	55		0	0	0	2

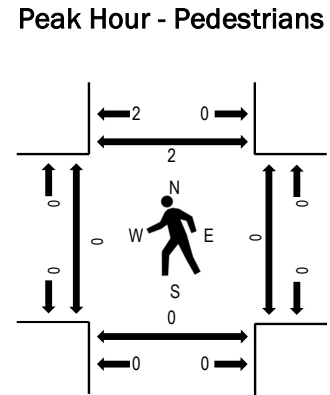
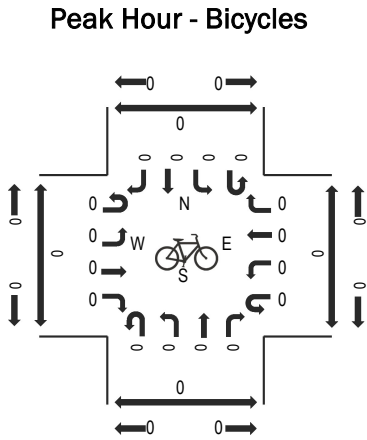
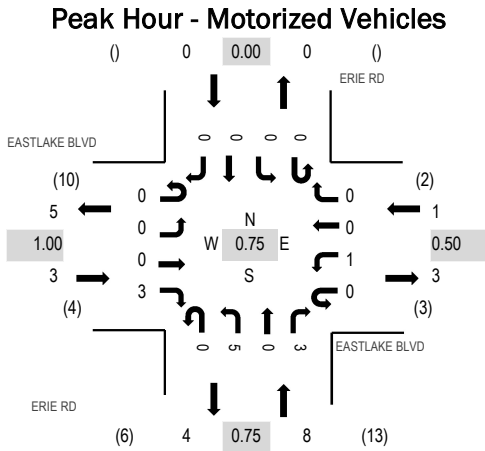

Note: Total study counts contained in parentheses.

Traffic Counts - Motorized Vehicles

Interval Start Time	EASTLAKE BLVD Eastbound				EASTLAKE BLVD Westbound				ERIE RD Northbound				ERIE RD Southbound				Total	Rolling Hour	Pedestrian Crossings			
	U-Turn	Left	Thru	Right	U-Turn	Left	Thru	Right	U-Turn	Left	Thru	Right	U-Turn	Left	Thru	Right			West	East	South	North
7:00 AM	0	0	0	0	0	0	0	0	0	2	0	0	0	0	0	0	2	11	0	0	0	0
7:15 AM	0	0	0	0	0	0	0	0	0	2	0	0	0	0	0	0	2	12	0	0	0	1
7:30 AM	0	0	0	1	0	0	0	0	0	0	0	3	0	0	0	0	4	12	0	0	0	1
7:45 AM	0	0	0	1	0	0	0	0	0	2	0	0	0	0	0	0	3	10	0	0	0	0
8:00 AM	0	0	0	1	0	1	0	0	0	1	0	0	0	0	0	0	3	8	0	0	0	0
8:15 AM	0	0	0	1	0	0	0	0	0	1	0	0	0	0	0	0	2		1	1	1	2
8:30 AM	0	0	0	0	0	1	0	0	0	1	0	0	0	0	0	0	2		0	0	0	0
8:45 AM	0	0	0	0	0	0	0	0	0	1	0	0	0	0	0	0	1		0	1	0	0
Count Total	0	0	0	4	0	2	0	0	0	10	0	3	0	0	0	0	19		1	2	1	4
Peak Hour	0	0	0	3	0	1	0	0	0	5	0	3	0	0	0	0	12		0	0	0	2

Peak Hour - Motorized Vehicles

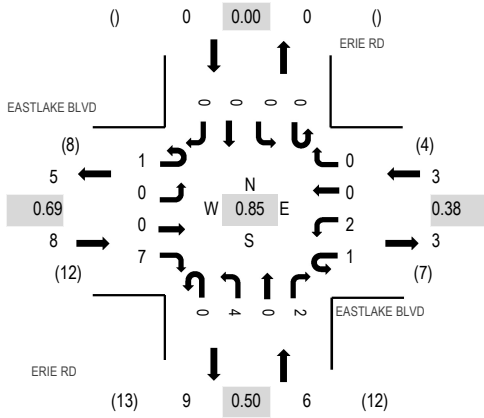

Peak Hour - Bicycles

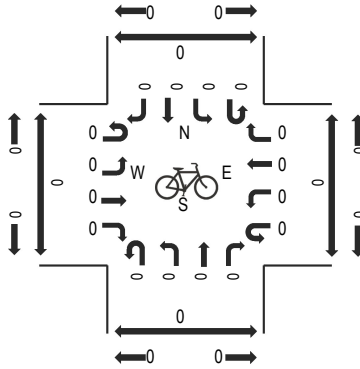

Peak Hour - Pedestrians

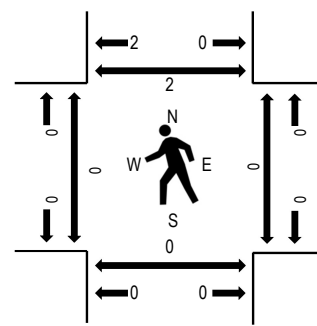

Note: Total study counts contained in parentheses.

Traffic Counts - Motorized Vehicles

Interval Start Time	EASTLAKE BLVD Eastbound				EASTLAKE BLVD Westbound				ERIE RD Northbound				ERIE RD Southbound				Total	Rolling Hour	Pedestrian Crossings			
	U-Turn	Left	Thru	Right	U-Turn	Left	Thru	Right	U-Turn	Left	Thru	Right	U-Turn	Left	Thru	Right			West	East	South	North
4:00 PM	0	0	0	0	0	0	0	0	0	1	0	2	0	0	0	0	3	13	0	1	0	1
4:15 PM	0	0	0	0	1	0	0	0	0	1	0	0	0	0	0	0	2	15	1	1	1	2
4:30 PM	0	0	0	3	0	0	0	0	0	0	0	0	0	0	0	0	3	15	0	0	0	0
4:45 PM	1	0	0	1	1	0	0	0	0	0	0	2	0	0	0	0	5	17	0	0	0	1
5:00 PM	0	0	0	4	0	0	0	0	0	1	0	0	0	0	0	0	5	15	0	0	0	0
5:15 PM	0	0	0	2	0	0	0	0	0	0	0	0	0	0	0	0	2		0	0	0	1
5:30 PM	0	0	0	0	0	2	0	0	0	3	0	0	0	0	0	0	5		0	0	0	0
5:45 PM	0	0	0	1	0	0	0	0	0	1	0	1	0	0	0	0	3		0	0	0	0
Count Total	1	0	0	11	2	2	0	0	0	7	0	5	0	0	0	0	28		1	2	1	5
Peak Hour	1	0	0	7	1	2	0	0	0	4	0	2	0	0	0	0	17		0	0	0	2

Peak Hour - Motorized Vehicles

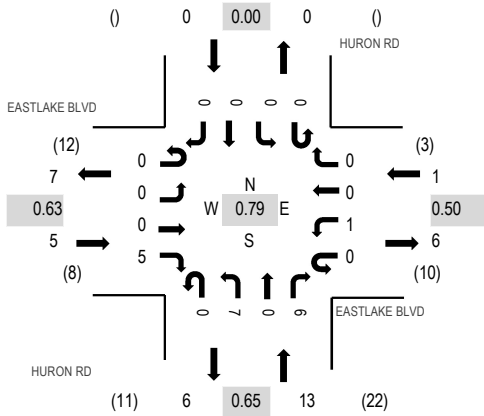

Peak Hour - Bicycles

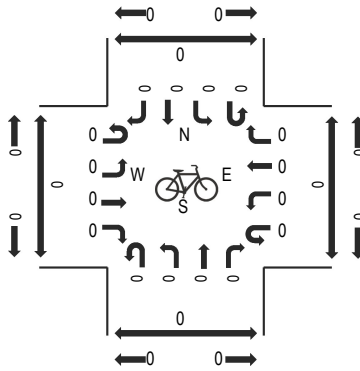

Peak Hour - Pedestrians

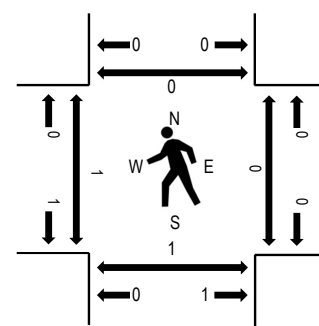

Note: Total study counts contained in parentheses.

Traffic Counts - Motorized Vehicles

Interval Start Time	EASTLAKE BLVD Eastbound				EASTLAKE BLVD Westbound				HURON RD Northbound				HURON RD Southbound				Total	Rolling Hour	Pedestrian Crossings			
	U-Turn	Left	Thru	Right	U-Turn	Left	Thru	Right	U-Turn	Left	Thru	Right	U-Turn	Left	Thru	Right			West	East	South	North
7:00 AM	0	0	0	1	0	1	0	0	0	1	0	1	0	0	0	0	4	14	0	0	0	0
7:15 AM	0	0	0	1	0	0	0	0	0	1	0	2	0	0	0	0	4	16	1	0	0	0
7:30 AM	0	0	0	0	0	0	0	0	0	1	0	1	0	0	0	0	2	17	0	0	0	0
7:45 AM	0	0	0	1	0	1	0	0	0	1	0	1	0	0	0	0	4	19	0	0	0	0
8:00 AM	0	0	0	1	0	0	0	0	0	2	0	3	0	0	0	0	6	19	0	0	0	0
8:15 AM	0	0	0	2	0	0	0	0	0	2	0	1	0	0	0	0	5		0	0	0	0
8:30 AM	0	0	0	1	0	0	0	0	0	2	0	1	0	0	0	0	4		1	0	1	0
8:45 AM	0	0	0	1	0	1	0	0	0	2	0	0	0	0	0	0	4		1	0	0	0
Count Total	0	0	0	8	0	3	0	0	0	12	0	10	0	0	0	0	33		3	0	1	0
Peak Hour	0	0	0	5	0	1	0	0	0	7	0	6	0	0	0	0	19		1	0	1	0

Location: 6 HURON RD & EASTLAKE BLVD PM

Date: Thursday, January 11, 2024

Peak Hour: 04:00 PM - 05:00 PM

Peak 15-Minutes: 04:00 PM - 04:15 PM

Peak Hour - Motorized Vehicles

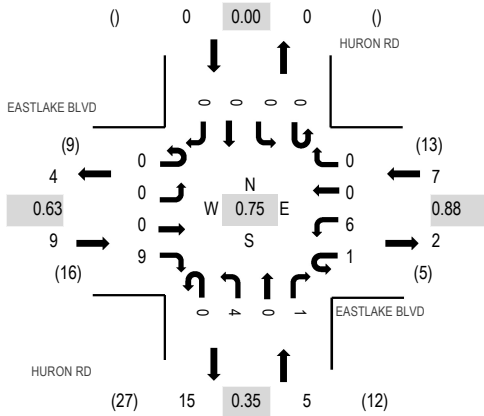

Peak Hour - Bicycles

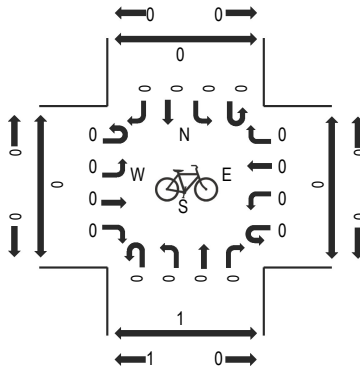

Peak Hour - Pedestrians

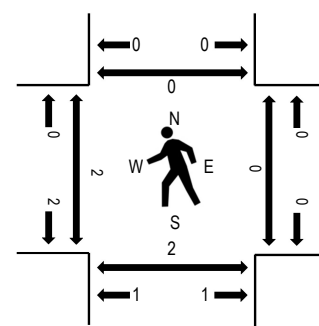

Note: Total study counts contained in parentheses.

Traffic Counts - Motorized Vehicles

Interval Start Time	EASTLAKE BLVD Eastbound				EASTLAKE BLVD Westbound				HURON RD Northbound				HURON RD Southbound				Total	Rolling Hour	Pedestrian Crossings			
	U-Turn	Left	Thru	Right	U-Turn	Left	Thru	Right	U-Turn	Left	Thru	Right	U-Turn	Left	Thru	Right			West	East	South	North
4:00 PM	0	0	0	3	0	2	0	0	0	2	0	0	0	0	0	0	7	21	0	0	0	0
4:15 PM	0	0	0	1	0	2	0	0	0	0	0	0	0	0	0	0	3	17	0	0	0	0
4:30 PM	0	0	0	3	1	1	0	0	0	1	0	0	0	0	0	0	6	20	1	0	1	0
4:45 PM	0	0	0	2	0	1	0	0	0	1	0	1	0	0	0	0	5	21	1	0	1	0
5:00 PM	0	0	0	1	0	2	0	0	0	0	0	0	0	0	0	0	3	20	0	0	0	0
5:15 PM	1	0	0	3	0	2	0	0	0	0	0	0	0	0	0	0	6		0	0	1	0
5:30 PM	0	0	0	1	0	1	0	0	0	3	0	2	0	0	0	0	7		0	0	1	0
5:45 PM	0	0	0	1	0	1	0	0	0	1	0	1	0	0	0	0	4		0	0	0	0
Count Total	1	0	0	15	1	12	0	0	0	8	0	4	0	0	0	0	41		2	0	4	0
Peak Hour	0	0	0	9	1	6	0	0	0	4	0	1	0	0	0	0	21		2	0	2	0

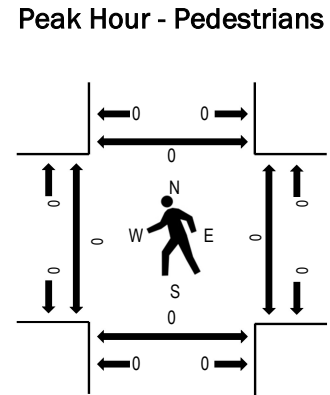
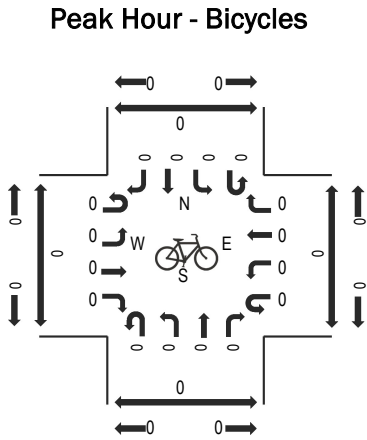
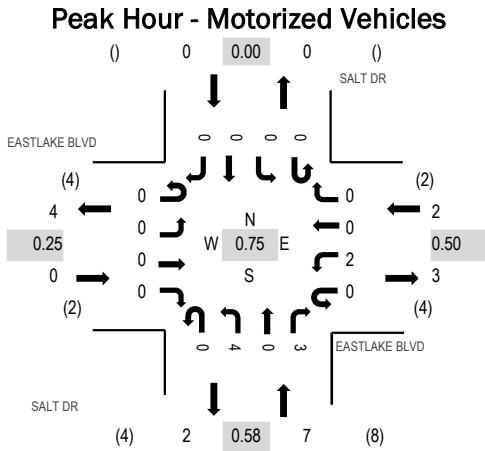

Note: Total study counts contained in parentheses.

Traffic Counts - Motorized Vehicles

Interval Start Time	EASTLAKE BLVD Eastbound				EASTLAKE BLVD Westbound				SALT DR Northbound				SALT DR Southbound				Total	Rolling Hour	Pedestrian Crossings			
	U-Turn	Left	Thru	Right	U-Turn	Left	Thru	Right	U-Turn	Left	Thru	Right	U-Turn	Left	Thru	Right			West	East	South	North
7:00 AM	0	0	0	1	0	0	0	0	0	0	0	0	0	0	0	0	1	7	0	0	0	0
7:15 AM	0	0	0	0	0	1	0	0	0	0	0	1	0	0	0	0	2	9	0	0	0	0
7:30 AM	0	0	0	0	0	0	0	0	0	2	0	1	0	0	0	0	3	8	0	0	0	0
7:45 AM	0	0	0	0	0	0	0	0	0	1	0	0	0	0	0	0	1	5	0	0	0	0
8:00 AM	0	0	0	0	0	1	0	0	0	1	0	1	0	0	0	0	3	5	0	0	0	0
8:15 AM	0	0	0	0	0	0	0	0	0	0	0	1	0	0	0	0	1	0	0	0	0	0
8:30 AM	0	0	0	0	0	0	0	0	0	0	0	0	0	0	0	0	0	0	0	0	0	0
8:45 AM	0	0	0	1	0	0	0	0	0	0	0	0	0	0	0	0	1	0	0	0	0	0
Count Total	0	0	0	2	0	2	0	0	0	4	0	4	0	0	0	0	12	0	0	0	0	0
Peak Hour	0	0	0	0	0	2	0	0	0	4	0	3	0	0	0	0	9	0	0	0	0	0

Peak Hour - Motorized Vehicles

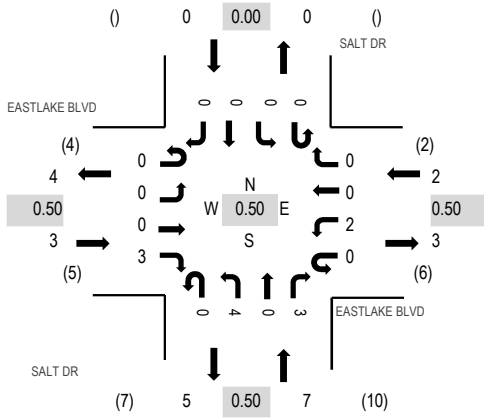

Peak Hour - Bicycles

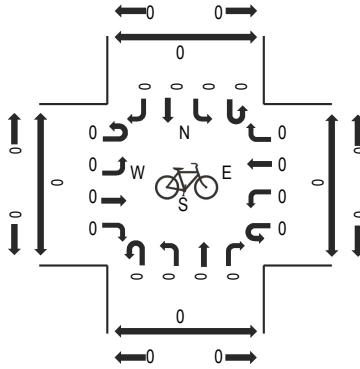

Peak Hour - Pedestrians

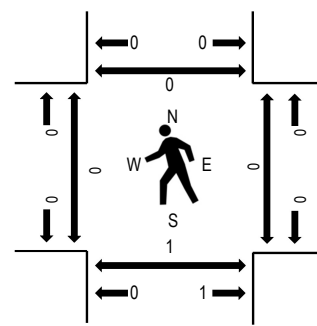

Note: Total study counts contained in parentheses.

Traffic Counts - Motorized Vehicles

Interval Start Time	EASTLAKE BLVD Eastbound				EASTLAKE BLVD Westbound				SALT DR Northbound			SALT DR Southbound				Total	Rolling Hour	Pedestrian Crossings				
	U-Turn	Left	Thru	Right	U-Turn	Left	Thru	Right	U-Turn	Left	Thru	Right	U-Turn	Left	Thru			Right	West	East	South	North
4:00 PM	0	0	0	1	0	0	0	0	0	0	0	2	0	0	0	0	3	11	0	0	0	0
4:15 PM	0	0	0	0	0	0	0	0	0	0	0	2	0	0	0	0	2	12	0	0	0	0
4:30 PM	0	0	0	1	0	1	0	0	0	3	0	1	0	0	0	0	6	11	0	0	0	0
4:45 PM	0	0	0	0	0	0	0	0	0	0	0	0	0	0	0	0	0	6	0	0	1	0
5:00 PM	0	0	0	2	0	1	0	0	0	1	0	0	0	0	0	0	4	6	0	0	0	0
5:15 PM	0	0	0	1	0	0	0	0	0	0	0	0	0	0	0	0	1		0	0	0	0
5:30 PM	0	0	0	0	0	0	0	0	0	0	0	1	0	0	0	0	1		0	0	0	0
5:45 PM	0	0	0	0	0	0	0	0	0	0	0	0	0	0	0	0	0		0	0	0	0
Count Total	0	0	0	5	0	2	0	0	0	4	0	6	0	0	0	0	17		0	0	1	0
Peak Hour	0	0	0	3	0	2	0	0	0	4	0	3	0	0	0	0	12		0	0	1	0

All Traffic Data Services

9660 W 44th Ave
Wheat Ridge, CO 80033

Site Code: 9
Station ID: 9
EASTLAKE BLVD S.O. AIRPORT RD

Start Time	11-Jan-24 Thu	NB	SB	Total
12:00 AM		2	3	5
01:00		4	5	9
02:00		6	2	8
03:00		3	3	6
04:00		2	7	9
05:00		10	16	26
06:00		31	44	75
07:00		68	97	165
08:00		62	78	140
09:00		52	62	114
10:00		60	52	112
11:00		72	81	153
12:00 PM		75	77	152
01:00		68	61	129
02:00		64	88	152
03:00		86	88	174
04:00		110	108	218
05:00		67	97	164
06:00		49	46	95
07:00		35	36	71
08:00		21	22	43
09:00		17	18	35
10:00		17	13	30
11:00		4	6	10
Total		985	1110	2095
Percent		47.0%	53.0%	
AM Peak	-	11:00	07:00	-
Vol.	-	72	97	-
PM Peak	-	16:00	16:00	-
Vol.	-	110	108	-
Grand Total		985	1110	2095
Percent		47.0%	53.0%	
ADT		ADT 2,095	AADT 2,095	

All Traffic Data Services

9660 W 44th Ave
Wheat Ridge, CO 80033

Site Code: 8
Station ID: 8
EASTLAKE BLVD E.O. UNION BLVD

Start Time	11-Jan-24 Thu	EB	WB	Total
12:00 AM		6	7	13
01:00		6	8	14
02:00		6	3	9
03:00		3	3	6
04:00		4	6	10
05:00		9	23	32
06:00		26	61	87
07:00		99	132	231
08:00		72	100	172
09:00		58	73	131
10:00		67	68	135
11:00		79	99	178
12:00 PM		102	98	200
01:00		84	82	166
02:00		99	92	191
03:00		108	106	214
04:00		133	120	253
05:00		88	111	199
06:00		55	55	110
07:00		48	35	83
08:00		33	31	64
09:00		24	18	42
10:00		24	15	39
11:00		10	9	19
Total		1243	1355	2598
Percent		47.8%	52.2%	
AM Peak	-	07:00	07:00	-
Vol.	-	99	132	-
PM Peak	-	16:00	16:00	-
Vol.	-	133	120	-
Grand Total		1243	1355	2598
Percent		47.8%	52.2%	
ADT		ADT 2,598	ADT 2,598	AADT 2,598

APPENDIX B

Signal Timing Information

Intersection 490 at Lake Blvd East and Union Blvd - Timing table, page 1

Page 1	Phases											
	1	2	3	4	5	6	7	8	9	10	11	12
Min Green	0	4	0	4	0	4	0	4	0	0	0	0
Passage Time I	0.0	3.0	0.0	2.0	0.0	3.0	0.0	2.0	0.0	0.0	0.0	0.0
Passage Time II	0.0	0.0	0.0	0.0	0.0	0.0	0.0	0.0	0.0	0.0	0.0	0.0
Max Green I	0	35	0	25	0	35	0	25	0	0	0	0
Max Green II	0	0	0	0	0	0	0	0	0	0	0	0
Yellow Clearance	0.0	3.5	0.0	4.0	0.0	3.5	0.0	4.0	0.0	0.0	0.0	0.0
Red Clearance	0.0	2.0	0.0	2.0	0.0	2.0	0.0	2.0	0.0	0.0	0.0	0.0
Added Initial	0.0	0.0	0.0	0.0	0.0	0.0	0.0	0.0	0.0	0.0	0.0	0.0
Max Added Initial	0	0	0	0	0	0	0	0	0	0	0	0
Time Before Reduction	0	0	0	0	0	0	0	0	0	0	0	0
Cars Before Reduction	0	0	0	0	0	0	0	0	0	0	0	0
Time To Reduce	0	0	0	0	0	0	0	0	0	0	0	0
Min Passage	0.0	0.0	0.0	0.0	0.0	0.0	0.0	0.0	0.0	0.0	0.0	0.0
Recall Green Time	0	0	0	0	0	0	0	0	0	0	0	0
Red Revert Time	0.0	0.0	0.0	0.0	0.0	0.0	0.0	0.0	0.0	0.0	0.0	0.0
Advance Walk Time	0	0	0	0	0	0	0	0	0	0	0	0
Walk Time	0	7	0	7	0	7	0	7	0	0	0	0
Pedestrian Clearance	0	22	0	28	0	22	0	28	0	0	0	0
Handicap Walk	0	0	0	0	0	0	0	0	0	0	0	0
Handicap Ped Clearance	0	0	0	0	0	0	0	0	0	0	0	0
Lake Blvd East				X				X				
Union Blvd		X				X						
Compass Direction		N		E		S		W				
Through, Turn or XPed		Thru		Thru		Thru		Thru				

Intersection 490 at Lake Blvd East and Union Blvd - Sequence table, page 1

Page 1	Ring 1 Phases			Ring 2 Phases			Ring 3 Phases					
	1	2	3	4	5	6	7	8	9	10	11	12
State 1		V & P				V & P						
Barrier 1	XXXXXXXXXXXXXXXXXXXX	XXXXXXXXXXXXXXXXXXXX	XXXXXXXXXXXXXXXXXXXX	XXXXXXXXXXXXXXXXXXXX	XXXXXXXXXXXXXXXXXXXX	XXXXXXXXXXXXXXXXXXXX	XXXXXXXXXXXXXXXXXXXX	XXXXXXXXXXXXXXXXXXXX				
State 2				V & P				V & P				
Barrier 2	XXXXXXXXXXXXXXXXXXXX	XXXXXXXXXXXXXXXXXXXX	XXXXXXXXXXXXXXXXXXXX	XXXXXXXXXXXXXXXXXXXX	XXXXXXXXXXXXXXXXXXXX	XXXXXXXXXXXXXXXXXXXX	XXXXXXXXXXXXXXXXXXXX	XXXXXXXXXXXXXXXXXXXX				
State 3												
Barrier 3												
State 4												
Barrier 4												
State 5												
Barrier 5												
State 6												
Barrier 6												
State 7												
Barrier 7												
State 8												
Barrier 8												
State 9												
Barrier 9												
State 10												
Barrier 10												
State 11												
Barrier 11												
State 12												
Barrier 12												

Intersection 490 at Lake Blvd East and Union Blvd - Phases control table, page 1

Page 1	Vehicle Phases	Ped Phases
	111 123456789012	111 123456789012
Min Recalls		Ped Recalls
Max Recalls	2 6	Handicap Ped Recalls
Recall If Maxed		Soft Ped Recalls
Dual Entry	4 8	Do Not Recall Ped
Do Not Skip		2 4 6 8
Simultaneous Gap Out		Allow Walk Reduction
Restricted Phases		Hold In Walk
Sequential Initial Timing		Allow Ped Re-service
Max Timer Starts For Call		2 6
Reduction Starts For Call		Rest In Walk
Red To Avoid Left Turn Trap		No
Rest In Red	No	

APPENDIX C

Internal Capture Worksheets

NCHRP 684 Internal Trip Capture Estimation Tool					
Project Name:	Dream Centers Campus	Organization:	SM ROCHA, LLC		
Project Location:	Colorado Springs, CO	Performed By:	MB		
Scenario Description:	AM Peak Hour	Date:	1/31/2024		
Analysis Year:	Development Build-Out	Checked By:			
Analysis Period:	AM Street Peak Hour	Date:			

Table 1-A: Base Vehicle-Trip Generation Estimates (Single-Use Site Estimate)						
Land Use	Development Data (For Information Only)			Estimated Vehicle-Trips ³		
	ITE LUCs ¹	Quantity	Units	Total	Entering	Exiting
Office	710	20	KSF	31	27	4
Retail	822	18	KSF	42	25	17
Restaurant	932	12	KSF	115	63	52
Cinema/Entertainment				0		
Residential	221, 231	237	DU	69	16	53
Hotel				0		
All Other Land Uses ²				0		
				257	131	126

Table 2-A: Mode Split and Vehicle Occupancy Estimates						
Land Use	Entering Trips			Exiting Trips		
	Veh. Occ. ⁴	% Transit	% Non-Motorized	Veh. Occ. ⁴	% Transit	% Non-Motorized
Office	1.11	16%	12%	1.11	16%	12%
Retail	1.00	6%	1%	1.00	6%	1%
Restaurant	1.00	19%	55%	1.00	19%	55%
Cinema/Entertainment						
Residential	1.16	15%	25%	1.16	15%	25%
Hotel						
All Other Land Uses ²						

Table 3-A: Average Land Use Interchange Distances (Feet Walking Distance)						
Origin (From)	Destination (To)					
	Office	Retail	Restaurant	Cinema/Entertainment	Residential	Hotel
Office						
Retail						
Restaurant						
Cinema/Entertainment						
Residential						
Hotel						

Table 4-A: Internal Person-Trip Origin-Destination Matrix*						
Origin (From)	Destination (To)					
	Office	Retail	Restaurant	Cinema/Entertainment	Residential	Hotel
Office		1	2	0	0	0
Retail	1		2	0	0	0
Restaurant	4	2		0	1	0
Cinema/Entertainment	0	0	0		0	0
Residential	1	1	12	0		0
Hotel	0	0	0	0	0	

Table 5-A: Computations Summary			
	Total	Entering	Exiting
All Person-Trips	271	137	134
Internal Capture Percentage	20%	20%	20%
External Vehicle-Trips ⁵	105	56	49
External Transit-Trips ⁶	34	17	17
External Non-Motorized Trips ⁶	71	34	37

Table 6-A: Internal Trip Capture Percentages by Land Use		
Land Use	Entering Trips	Exiting Trips
Office	20%	75%
Retail	16%	18%
Restaurant	25%	13%
Cinema/Entertainment	N/A	N/A
Residential	5%	23%
Hotel	N/A	N/A

¹Land Use Codes (LUCs) from *Trip Generation Manual*, published by the Institute of Transportation Engineers.

²Total estimate for all other land uses at mixed-use development site is not subject to internal trip capture computations in this estimator.

³Enter trips assuming no transit or non-motorized trips (as assumed in *ITE Trip Generation Manual*).

⁴Enter vehicle occupancy assumed in Table 1-A vehicle trips. If vehicle occupancy changes for proposed mixed-use project, manual adjustments must be made to Tables 5-A, 9-A (O and D). Enter transit, non-motorized percentages that will result with proposed mixed-use project complete.

⁵Vehicle-trips computed using the mode split and vehicle occupancy values provided in Table 2-A.

⁶Person-Trips

*Indicates computation that has been rounded to the nearest whole number.

Estimation Tool Developed by the Texas A&M Transportation Institute - Version 2013.1

Project Name:	Dream Centers Campus
Analysis Period:	AM Street Peak Hour

Table 7-A: Conversion of Vehicle-Trip Ends to Person-Trip Ends						
Land Use	Table 7-A (D): Entering Trips			Table 7-A (O): Exiting Trips		
	Veh. Occ.	Vehicle-Trips	Person-Trips*	Veh. Occ.	Vehicle-Trips	Person-Trips*
Office	1.11	27	30	1.11	4	4
Retail	1.00	25	25	1.00	17	17
Restaurant	1.00	63	63	1.00	52	52
Cinema/Entertainment	1.00	0	0	1.00	0	0
Residential	1.16	16	19	1.16	53	61
Hotel	1.00	0	0	1.00	0	0

Table 8-A (O): Internal Person-Trip Origin-Destination Matrix (Computed at Origin)						
Origin (From)	Destination (To)					
	Office	Retail	Restaurant	Cinema/Entertainment	Residential	Hotel
Office		1	3	0	0	0
Retail	5		2	0	2	0
Restaurant	16	7		0	2	2
Cinema/Entertainment	0	0	0		0	0
Residential	1	1	12	0		0
Hotel	0	0	0	0	0	

Table 8-A (D): Internal Person-Trip Origin-Destination Matrix (Computed at Destination)						
Origin (From)	Destination (To)					
	Office	Retail	Restaurant	Cinema/Entertainment	Residential	Hotel
Office		8	14	0	0	0
Retail	1		32	0	0	0
Restaurant	4	2		0	1	0
Cinema/Entertainment	0	0	0		0	0
Residential	1	4	13	0		0
Hotel	1	1	4	0	0	

Table 9-A (D): Internal and External Trips Summary (Entering Trips)						
Destination Land Use	Person-Trip Estimates			External Trips by Mode*		
	Internal	External	Total	Vehicles ¹	Transit ²	Non-Motorized ²
Office	6	24	30	15	4	3
Retail	4	21	25	20	1	0
Restaurant	16	47	63	12	9	26
Cinema/Entertainment	0	0	0	0	0	0
Residential	1	18	19	9	3	5
Hotel	0	0	0	0	0	0
All Other Land Uses ³	0	0	0	0	0	0

Table 9-A (O): Internal and External Trips Summary (Exiting Trips)						
Origin Land Use	Person-Trip Estimates			External Trips by Mode*		
	Internal	External	Total	Vehicles ¹	Transit ²	Non-Motorized ²
Office	3	1	4	1	0	0
Retail	3	14	17	13	1	0
Restaurant	7	45	52	11	9	25
Cinema/Entertainment	0	0	0	0	0	0
Residential	14	47	61	24	7	12
Hotel	0	0	0	0	0	0
All Other Land Uses ³	0	0	0	0	0	0

¹Vehicle-trips computed using the mode split and vehicle occupancy values provided in Table 2-A
²Person-Trips
³Total estimate for all other land uses at mixed-use development site is not subject to internal trip capture computations in this estimator
*Indicates computation that has been rounded to the nearest whole number.

NCHRP 684 Internal Trip Capture Estimation Tool					
Project Name:	Dream Centers Campus	Organization:	SM ROCHA, LLC		
Project Location:	Colorado Springs, CO	Performed By:	MB		
Scenario Description:	PM Peak Hour	Date:	1/31/2024		
Analysis Year:	Development Build-Out	Checked By:			
Analysis Period:	PM Street Peak Hour	Date:			

Table 1-P: Base Vehicle-Trip Generation Estimates (Single-Use Site Estimate)						
Land Use	Development Data (For Information Only)			Estimated Vehicle-Trips ³		
	ITE LUCs ¹	Quantity	Units	Total	Entering	Exiting
Office	710	20	KSF	29	5	24
Retail	822	18	KSF	118	59	59
Restaurant	932	12	KSF	108	66	42
Cinema/Entertainment				0		
Residential	221, 231	237	DU	63	38	25
Hotel				0		
All Other Land Uses ²				0		
				318	168	150

Table 2-P: Mode Split and Vehicle Occupancy Estimates						
Land Use	Entering Trips			Exiting Trips		
	Veh. Occ. ⁴	% Transit	% Non-Motorized	Veh. Occ. ⁴	% Transit	% Non-Motorized
Office	1.12	17%	14%	1.12	17%	14%
Retail	1.00	16%	16%	1.00	16%	16%
Restaurant	1.00	29%	28%	1.00	29%	28%
Cinema/Entertainment						
Residential	1.22	13%	32%	1.22	13%	32%
Hotel						
All Other Land Uses ²						

Table 3-P: Average Land Use Interchange Distances (Feet Walking Distance)						
Origin (From)	Destination (To)					
	Office	Retail	Restaurant	Cinema/Entertainment	Residential	Hotel
Office						
Retail						
Restaurant						
Cinema/Entertainment						
Residential						
Hotel						

Table 4-P: Internal Person-Trip Origin-Destination Matrix*						
Origin (From)	Destination (To)					
	Office	Retail	Restaurant	Cinema/Entertainment	Residential	Hotel
Office		5	1	0	1	0
Retail	1		17	0	15	0
Restaurant	1	17		0	7	0
Cinema/Entertainment	0	0	0		0	0
Residential	1	6	7	0		0
Hotel	0	0	0	0	0	

Table 5-P: Computations Summary			
	Total	Entering	Exiting
All Person-Trips	336	177	159
Internal Capture Percentage	47%	45%	50%
External Vehicle-Trips ⁵	98	52	46
External Transit-Trips ⁶	35	21	14
External Non-Motorized Trips ⁶	40	23	17

Table 6-P: Internal Trip Capture Percentages by Land Use		
Land Use	Entering Trips	Exiting Trips
Office	50%	26%
Retail	47%	56%
Restaurant	38%	60%
Cinema/Entertainment	N/A	N/A
Residential	50%	45%
Hotel	N/A	N/A

¹Land Use Codes (LUCs) from *Trip Generation Manual*, published by the Institute of Transportation Engineers.

²Total estimate for all other land uses at mixed-use development site is not subject to internal trip capture computations in this estimator.

³Enter trips assuming no transit or non-motorized trips (as assumed in *ITE Trip Generation Manual*).

⁴Enter vehicle occupancy assumed in Table 1-P vehicle trips. If vehicle occupancy changes for proposed mixed-use project, manual adjustments must be made.

⁵Vehicle-trips computed using the mode split and vehicle occupancy values provided in Table 2-P.

⁶Person-Trips

*Indicates computation that has been rounded to the nearest whole number.

Estimation Tool Developed by the Texas A&M Transportation Institute - Version 2013.1

Project Name:	Dream Centers Campus
Analysis Period:	PM Street Peak Hour

Table 7-P: Conversion of Vehicle-Trip Ends to Person-Trip Ends						
Land Use	Table 7-P (D): Entering Trips			Table 7-P (O): Exiting Trips		
	Veh. Occ.	Vehicle-Trips	Person-Trips*	Veh. Occ.	Vehicle-Trips	Person-Trips*
Office	1.12	5	6	1.12	24	27
Retail	1.00	59	59	1.00	59	59
Restaurant	1.00	66	66	1.00	42	42
Cinema/Entertainment	1.00	0	0	1.00	0	0
Residential	1.22	38	46	1.22	25	31
Hotel	1.00	0	0	1.00	0	0

Table 8-P (O): Internal Person-Trip Origin-Destination Matrix (Computed at Origin)						
Origin (From)	Destination (To)					
	Office	Retail	Restaurant	Cinema/Entertainment	Residential	Hotel
Office		5	1	0	1	0
Retail	1		17	2	15	3
Restaurant	1	17		3	8	3
Cinema/Entertainment	0	0	0		0	0
Residential	1	13	7	0		1
Hotel	0	0	0	0	0	

Table 8-P (D): Internal Person-Trip Origin-Destination Matrix (Computed at Destination)						
Origin (From)	Destination (To)					
	Office	Retail	Restaurant	Cinema/Entertainment	Residential	Hotel
Office		5	1	0	2	0
Retail	2		19	0	21	0
Restaurant	2	30		0	7	0
Cinema/Entertainment	0	2	2		2	0
Residential	3	6	9	0		0
Hotel	0	1	3	0	0	

Table 9-P (D): Internal and External Trips Summary (Entering Trips)						
Destination Land Use	Person-Trip Estimates			External Trips by Mode*		
	Internal	External	Total	Vehicles ¹	Transit ²	Non-Motorized ²
Office	3	3	6	2	1	0
Retail	28	31	59	21	5	5
Restaurant	25	41	66	18	12	11
Cinema/Entertainment	0	0	0	0	0	0
Residential	23	23	46	11	3	7
Hotel	0	0	0	0	0	0
All Other Land Uses ³	0	0	0	0	0	0

Table 9-P (O): Internal and External Trips Summary (Exiting Trips)						
Origin Land Use	Person-Trip Estimates			External Trips by Mode*		
	Internal	External	Total	Vehicles ¹	Transit ²	Non-Motorized ²
Office	7	20	27	13	3	3
Retail	33	26	59	18	4	4
Restaurant	25	17	42	7	5	5
Cinema/Entertainment	0	0	0	0	0	0
Residential	14	17	31	8	2	5
Hotel	0	0	0	0	0	0
All Other Land Uses ³	0	0	0	0	0	0

¹Vehicle-trips computed using the mode split and vehicle occupancy values provided in Table 2-P
²Person-Trips
³Total estimate for all other land uses at mixed-use development site is not subject to internal trip capture computations in this estimator
*Indicates computation that has been rounded to the nearest whole number.

APPENDIX D

Level of Service Definitions

The following information is referenced from the Highway Capacity Manual: A Guide for Multimodal Mobility Analysis, 6th Edition, Transportation Research Board, 2016: Chapter 19 – Signalized Intersections.

Motorized Vehicle Level of Service (LOS) for Signalized Intersections

Levels of service are defined to represent reasonable ranges in control delay.

LOS A Describes operations with a control delay of 10 s/veh or less and a volume-to-capacity ratio no greater than 1.0. This level is typically assigned when the volume-to-capacity ratio is low and either progression is exceptionally favorable or the cycle length is very short. If it is due to favorable progression, most vehicles arrive during the green indication and travel through the intersection without stopping.

LOS B Describes operations with control delay between 10 and 20 s/veh and a volume-to-capacity ratio no greater than 1.0. This level is typically assigned when the volume-to-capacity ratio is low and either progression is highly favorable or the cycle length is short. More vehicles stop than with LOS A.

LOS C Describes operations with control delay between 20 and 35 s/veh and a volume-to-capacity ratio no greater than 1.0. This level is typically assigned when progression is favorable or the cycle length is moderate. Individual *cycle failures* (i.e., one or more queued vehicles are not able to depart as a result of insufficient capacity during the cycle) may begin to appear at this level. The number of vehicles stopping is significant, although many vehicles still pass through the intersection without stopping.

LOS D Describes operations with control delay between 35 and 55 s/veh and a volume-to-capacity ratio no greater than 1.0. This level is typically assigned when the volume-to-capacity ratio is high and either progression is ineffective or the cycle length is long. Many vehicles stop and individual cycle failures are noticeable.

LOS E Describes operations with control delay between 55 and 80 s/veh and a volume-to-capacity ratio no greater than 1.0. This level is typically assigned when the volume-to-capacity ratio is high, progression is unfavorable, and the cycle length is long. Individual cycle failures are frequent.

LOS F Describes operations with control delay exceeding 80 s/veh or a volume-to-capacity ratio greater than 1.0. This level is typically assigned when the volume-to-capacity ratio is very high, progression is very poor, and the cycle length is long. Most cycles fail to clear the queue.

Control Delay (s/veh)	LOS by Volume-to-Capacity Ratio ^a	
	$v/c \leq 1.0$	$v/c > 1.0$
≤ 10	A	F
> 10 – 20	B	F
> 20 – 35	C	F
> 35 – 55	D	F
> 55 – 80	E	F
> 80	F	F

Note: ^a For approach-based and intersectionwide assessments, LOS is defined solely by control delay.

The following information is referenced from the Highway Capacity Manual: A Guide for Multimodal Mobility Analysis, 6th Edition, Transportation Research Board, 2016: Chapter 20 – Two-Way Stop-Controlled Intersections, Chapter 21 – All-Way Stop-Controlled Intersections, and Chapter 22 - Roundabouts.

Motorized Vehicle Level of Service (LOS) for Unsignalized & Roundabout Intersections

LOS is a quantitative stratification of performance measure(s) representing quality of service. Quality of service describes how well a transportation facility or service operates from a traveler’s perspective. LOS is measured on an A – F scale, with LOS A representing the best operating conditions from a traveler’s perspective.

Control Delay (s/veh)	LOS by Volume-to-Capacity Ratio ^a	
	v/c ≤ 1.0	v/c > 1.0
0 – 10	A	F
> 10 – 15	B	F
> 15 – 25	C	F
> 25 – 35	D	F
> 35 – 50	E	F
> 50	F	F

Note: The LOS criteria apply to each lane on a given approach and to each approach on the minor street. LOS is not calculated for major-street approaches or for the intersection as a whole.

























^a For approaches and intersectionwide assessment, LOS is defined solely by control delay.

APPENDIX E

Capacity Worksheets

Timings
1: S Union Boulevard & Eastlake Boulevard

Existing Traffic Conditions
AM Peak Hour

												
Lane Group	EBL	EBT	EBR	WBL	WBT	WBR	NBL	NBT	NBR	SBL	SBT	SBR
Lane Configurations												
Traffic Volume (vph)	37	61	20	53	61	27	11	755	35	13	441	31
Future Volume (vph)	37	61	20	53	61	27	11	755	35	13	441	31
Satd. Flow (prot)	1770	1863	1583	1770	1863	1583	1770	3514	0	1770	3539	1583
Flt Permitted	0.714			0.714			0.478			0.324		
Satd. Flow (perm)	1330	1863	1583	1330	1863	1583	890	3514	0	604	3539	1583
Satd. Flow (RTOR)			45			45		11				55
Lane Group Flow (vph)	40	66	22	58	66	29	12	859	0	14	479	34
Turn Type	Perm	NA	Perm	Perm	NA	Perm	Perm	NA		Perm	NA	Perm
Protected Phases		4			8			2			6	
Permitted Phases	4		4	8		8	2			6		6
Detector Phase	4	4	4	8	8	8	2	2		6	6	6
Switch Phase												
Minimum Initial (s)	4.0	4.0	4.0	4.0	4.0	4.0	4.0	4.0		4.0	4.0	4.0
Minimum Split (s)	10.0	10.0	10.0	10.0	10.0	10.0	9.5	9.5		9.5	9.5	9.5
Total Split (s)	25.0	25.0	25.0	25.0	25.0	25.0	35.0	35.0		35.0	35.0	35.0
Total Split (%)	41.7%	41.7%	41.7%	41.7%	41.7%	41.7%	58.3%	58.3%		58.3%	58.3%	58.3%
Yellow Time (s)	4.0	4.0	4.0	4.0	4.0	4.0	3.5	3.5		3.5	3.5	3.5
All-Red Time (s)	2.0	2.0	2.0	2.0	2.0	2.0	2.0	2.0		2.0	2.0	2.0
Lost Time Adjust (s)	0.0	0.0	0.0	0.0	0.0	0.0	0.0	0.0		0.0	0.0	0.0
Total Lost Time (s)	6.0	6.0	6.0	6.0	6.0	6.0	5.5	5.5		5.5	5.5	5.5
Lead/Lag												
Lead-Lag Optimize?												
Recall Mode	None	None	None	None	None	None	C-Max	C-Max		C-Max	C-Max	C-Max
Act Effct Green (s)	8.1	8.1	8.1	8.1	8.1	8.1	43.8	43.8		43.8	43.8	43.8
Actuated g/C Ratio	0.14	0.14	0.14	0.14	0.14	0.14	0.73	0.73		0.73	0.73	0.73
v/c Ratio	0.22	0.26	0.09	0.32	0.26	0.11	0.02	0.33		0.03	0.19	0.03
Control Delay	25.1	24.9	4.2	27.4	24.9	6.1	4.2	4.6		4.4	4.0	0.9
Queue Delay	0.0	0.0	0.0	0.0	0.0	0.0	0.0	0.0		0.0	0.0	0.0
Total Delay	25.1	24.9	4.2	27.4	24.9	6.1	4.2	4.6		4.4	4.0	0.9
LOS	C	C	A	C	C	A	A	A		A	A	A
Approach Delay		21.4			22.3			4.6			3.8	
Approach LOS		C			C			A			A	
Queue Length 50th (ft)	13	22	0	19	22	0	1	55		1	27	0
Queue Length 95th (ft)	35	50	9	46	50	13	6	98		7	52	5
Internal Link Dist (ft)		416			208			351			547	
Turn Bay Length (ft)	65		60	40		40	100			125		30
Base Capacity (vph)	421	589	532	421	589	532	649	2565		440	2581	1169
Starvation Cap Reductn	0	0	0	0	0	0	0	0		0	0	0
Spillback Cap Reductn	0	0	0	0	0	0	0	0		0	0	0
Storage Cap Reductn	0	0	0	0	0	0	0	0		0	0	0
Reduced v/c Ratio	0.10	0.11	0.04	0.14	0.11	0.05	0.02	0.33		0.03	0.19	0.03
Intersection Summary												
Cycle Length: 60												
Actuated Cycle Length: 60												
Offset: 0 (0%), Referenced to phase 2:NBTL and 6:SBTL, Start of Green												
Natural Cycle: 40												
Control Type: Actuated-Coordinated												

Timings
 1: S Union Boulevard & Eastlake Boulevard

Existing Traffic Conditions
 AM Peak Hour

Maximum v/c Ratio: 0.33	
Intersection Signal Delay: 7.2	Intersection LOS: A
Intersection Capacity Utilization 43.2%	ICU Level of Service A
Analysis Period (min) 15	

Splits and Phases: 1: S Union Boulevard & Eastlake Boulevard

 Ø2 (R) 35 s	 Ø4 25 s
 Ø6 (R) 35 s	 Ø8 25 s

HCM 6th TWSC
2: S Union Boulevard & Airport Road

Existing Traffic Conditions
AM Peak Hour

Intersection						
Int Delay, s/veh	0.8					
Movement	WBL	WBR	NBT	NBR	SBL	SBT
Lane Configurations	↘	↗	↑↑	↗	↘	↑↑
Traffic Vol, veh/h	21	66	798	23	36	798
Future Vol, veh/h	21	66	798	23	36	798
Conflicting Peds, #/hr	0	0	0	0	0	0
Sign Control	Stop	Stop	Free	Free	Free	Free
RT Channelized	-	None	-	None	-	None
Storage Length	0	70	-	60	350	-
Veh in Median Storage, #	0	-	0	-	-	0
Grade, %	0	-	0	-	-	0
Peak Hour Factor	92	92	92	92	92	92
Heavy Vehicles, %	2	2	2	2	2	2
Mvmt Flow	23	72	867	25	39	867

Major/Minor	Minor1	Major1	Major2			
Conflicting Flow All	1379	434	0	0	892	0
Stage 1	867	-	-	-	-	-
Stage 2	512	-	-	-	-	-
Critical Hdwy	6.84	6.94	-	-	4.14	-
Critical Hdwy Stg 1	5.84	-	-	-	-	-
Critical Hdwy Stg 2	5.84	-	-	-	-	-
Follow-up Hdwy	3.52	3.32	-	-	2.22	-
Pot Cap-1 Maneuver	*264	*762	-	-	1136	-
Stage 1	*719	-	-	-	-	-
Stage 2	*567	-	-	-	-	-
Platoon blocked, %	1	1	-	-	1	-
Mov Cap-1 Maneuver	*255	*762	-	-	1136	-
Mov Cap-2 Maneuver	*397	-	-	-	-	-
Stage 1	*719	-	-	-	-	-
Stage 2	*548	-	-	-	-	-

Approach	WB	NB	SB
HCM Control Delay, s	11.3	0	0.4
HCM LOS	B		

Minor Lane/Major Mvmt	NBT	NBR	WBLn1	WBLn2	SBL	SBT
Capacity (veh/h)	-	-	397	762	1136	-
HCM Lane V/C Ratio	-	-	0.057	0.094	0.034	-
HCM Control Delay (s)	-	-	14.6	10.2	8.3	-
HCM Lane LOS	-	-	B	B	A	-
HCM 95th %tile Q(veh)	-	-	0.2	0.3	0.1	-

Notes
 ~: Volume exceeds capacity \$: Delay exceeds 300s +: Computation Not Defined *: All major volume in platoon

HCM 6th TWSC
3: Eastlake Boulevard & Airport Road

Existing Traffic Conditions
AM Peak Hour

Intersection						
Int Delay, s/veh	4.7					
Movement	EBT	EBR	WBL	WBT	NEL	NER
Lane Configurations	↶		↷	↶	↷	↷
Traffic Vol, veh/h	53	2	98	78	7	72
Future Vol, veh/h	53	2	98	78	7	72
Conflicting Peds, #/hr	0	0	0	0	0	0
Sign Control	Free	Free	Free	Free	Stop	Stop
RT Channelized	-	None	-	None	-	None
Storage Length	-	-	400	-	80	-
Veh in Median Storage, #	0	-	-	0	0	-
Grade, %	0	-	-	0	0	-
Peak Hour Factor	92	92	92	92	92	92
Heavy Vehicles, %	2	2	2	2	2	2
Mvmt Flow	58	2	107	85	8	78

Major/Minor	Major1	Major2	Minor1			
Conflicting Flow All	0	0	60	0	358	59
Stage 1	-	-	-	-	59	-
Stage 2	-	-	-	-	299	-
Critical Hdwy	-	-	4.12	-	6.42	6.22
Critical Hdwy Stg 1	-	-	-	-	5.42	-
Critical Hdwy Stg 2	-	-	-	-	5.42	-
Follow-up Hdwy	-	-	2.218	-	3.518	3.318
Pot Cap-1 Maneuver	-	-	1544	-	640	1007
Stage 1	-	-	-	-	964	-
Stage 2	-	-	-	-	752	-
Platoon blocked, %	-	-	-	-	-	-
Mov Cap-1 Maneuver	-	-	1544	-	596	1007
Mov Cap-2 Maneuver	-	-	-	-	596	-
Stage 1	-	-	-	-	964	-
Stage 2	-	-	-	-	700	-

Approach	EB	WB	NE
HCM Control Delay, s	0	4.2	9.1
HCM LOS			A

Minor Lane/Major Mvmt	NELn1	NELn2	EBT	EBR	WBL	WBT
Capacity (veh/h)	596	1007	-	-	1544	-
HCM Lane V/C Ratio	0.013	0.078	-	-	0.069	-
HCM Control Delay (s)	11.1	8.9	-	-	7.5	-
HCM Lane LOS	B	A	-	-	A	-
HCM 95th %tile Q(veh)	0	0.3	-	-	0.2	-

Intersection						
Int Delay, s/veh	0.4					
Movement	NWL	NWR	NET	NER	SWL	SWT
Lane Configurations	Y		B			A
Traffic Vol, veh/h	4	3	75	0	2	98
Future Vol, veh/h	4	3	75	0	2	98
Conflicting Peds, #/hr	0	0	0	0	0	0
Sign Control	Stop	Stop	Free	Free	Free	Free
RT Channelized	-	None	-	None	-	None
Storage Length	0	-	-	-	-	-
Veh in Median Storage, #	0	-	0	-	-	0
Grade, %	0	-	0	-	-	0
Peak Hour Factor	92	92	92	92	92	92
Heavy Vehicles, %	2	2	2	2	2	2
Mvmt Flow	4	3	82	0	2	107

Major/Minor	Minor1	Major1	Major2			
Conflicting Flow All	193	82	0	0	82	0
Stage 1	82	-	-	-	-	-
Stage 2	111	-	-	-	-	-
Critical Hdwy	6.42	6.22	-	-	4.12	-
Critical Hdwy Stg 1	5.42	-	-	-	-	-
Critical Hdwy Stg 2	5.42	-	-	-	-	-
Follow-up Hdwy	3.518	3.318	-	-	2.218	-
Pot Cap-1 Maneuver	796	978	-	-	1515	-
Stage 1	941	-	-	-	-	-
Stage 2	914	-	-	-	-	-
Platoon blocked, %			-	-		-
Mov Cap-1 Maneuver	795	978	-	-	1515	-
Mov Cap-2 Maneuver	785	-	-	-	-	-
Stage 1	941	-	-	-	-	-
Stage 2	913	-	-	-	-	-

Approach	NW	NE	SW
HCM Control Delay, s	9.2	0	0.1
HCM LOS	A		

Minor Lane/Major Mvmt	NET	NER	NWLn1	SWL	SWT
Capacity (veh/h)	-	-	858	1515	-
HCM Lane V/C Ratio	-	-	0.009	0.001	-
HCM Control Delay (s)	-	-	9.2	7.4	0
HCM Lane LOS	-	-	A	A	A
HCM 95th %tile Q(veh)	-	-	0	0	-

HCM 6th TWSC
5: Eastlake Boulevard & Huron Road

Existing Traffic Conditions
AM Peak Hour

Intersection						
Int Delay, s/veh	0.7					
Movement	WBL	WBR	NET	NER	SWL	SWT
Lane Configurations	↔		↔		↔	↔
Traffic Vol, veh/h	7	6	69	5	1	101
Future Vol, veh/h	7	6	69	5	1	101
Conflicting Peds, #/hr	0	0	0	0	0	0
Sign Control	Stop	Stop	Free	Free	Free	Free
RT Channelized	-	None	-	None	-	None
Storage Length	0	-	-	-	200	-
Veh in Median Storage, #	0	-	0	-	-	0
Grade, %	0	-	0	-	-	0
Peak Hour Factor	92	92	92	92	92	92
Heavy Vehicles, %	2	2	2	2	2	2
Mvmt Flow	8	7	75	5	1	110

Major/Minor	Minor1	Major1	Major2			
Conflicting Flow All	190	78	0	0	80	0
Stage 1	78	-	-	-	-	-
Stage 2	112	-	-	-	-	-
Critical Hdwy	6.42	6.22	-	-	4.12	-
Critical Hdwy Stg 1	5.42	-	-	-	-	-
Critical Hdwy Stg 2	5.42	-	-	-	-	-
Follow-up Hdwy	3.518	3.318	-	-	2.218	-
Pot Cap-1 Maneuver	799	983	-	-	1518	-
Stage 1	945	-	-	-	-	-
Stage 2	913	-	-	-	-	-
Platoon blocked, %			-	-		-
Mov Cap-1 Maneuver	798	983	-	-	1518	-
Mov Cap-2 Maneuver	798	-	-	-	-	-
Stage 1	945	-	-	-	-	-
Stage 2	912	-	-	-	-	-

Approach	WB	NE	SW
HCM Control Delay, s	9.2	0	0.1
HCM LOS	A		

Minor Lane/Major Mvmt	NET	NERWBLn1	SWL	SWT
Capacity (veh/h)	-	-	874	1518
HCM Lane V/C Ratio	-	-	0.016	0.001
HCM Control Delay (s)	-	-	9.2	7.4
HCM Lane LOS	-	-	A	A
HCM 95th %tile Q(veh)	-	-	0	0

HCM 6th TWSC
6: Eastlake Boulevard & Erie Road

Existing Traffic Conditions
AM Peak Hour

Intersection						
Int Delay, s/veh	0.4					
Movement	NWL	NWR	NET	NER	SWL	SWT
Lane Configurations	↙↘		↔		↙	↘
Traffic Vol, veh/h	5	3	71	3	1	107
Future Vol, veh/h	5	3	71	3	1	107
Conflicting Peds, #/hr	0	0	0	0	0	0
Sign Control	Stop	Stop	Free	Free	Free	Free
RT Channelized	-	None	-	None	-	None
Storage Length	0	-	-	-	180	-
Veh in Median Storage, #	0	-	0	-	-	0
Grade, %	0	-	0	-	-	0
Peak Hour Factor	92	92	92	92	92	92
Heavy Vehicles, %	2	2	2	2	2	2
Mvmt Flow	5	3	77	3	1	116

Major/Minor	Minor1	Major1	Major2		
Conflicting Flow All	197	79	0	0	80
Stage 1	79	-	-	-	-
Stage 2	118	-	-	-	-
Critical Hdwy	6.42	6.22	-	-	4.12
Critical Hdwy Stg 1	5.42	-	-	-	-
Critical Hdwy Stg 2	5.42	-	-	-	-
Follow-up Hdwy	3.518	3.318	-	-	2.218
Pot Cap-1 Maneuver	792	981	-	-	1518
Stage 1	944	-	-	-	-
Stage 2	907	-	-	-	-
Platoon blocked, %			-	-	-
Mov Cap-1 Maneuver	791	981	-	-	1518
Mov Cap-2 Maneuver	782	-	-	-	-
Stage 1	944	-	-	-	-
Stage 2	906	-	-	-	-

Approach	NW	NE	SW
HCM Control Delay, s	9.3	0	0.1
HCM LOS	A		

Minor Lane/Major Mvmt	NET	NERNWLn1	SWL	SWT
Capacity (veh/h)	-	-	846	1518
HCM Lane V/C Ratio	-	-	0.01	0.001
HCM Control Delay (s)	-	-	9.3	7.4
HCM Lane LOS	-	-	A	A
HCM 95th %tile Q(veh)	-	-	0	0

HCM 6th TWSC
7: Manitoba Drive/Access A & Eastlake Boulevard

Existing Traffic Conditions
AM Peak Hour

Intersection												
Int Delay, s/veh	2.2											
Movement	EBL	EBT	EBR	WBL	WBT	WBR	NBL	NBT	NBR	SBL	SBT	SBR
Lane Configurations	↖	↗		↖	↗			↕			↕	
Traffic Vol, veh/h	15	71	23	1	100	11	32	0	1	2	0	11
Future Vol, veh/h	15	71	23	1	100	11	32	0	1	2	0	11
Conflicting Peds, #/hr	0	0	0	0	0	0	0	0	0	0	0	0
Sign Control	Free	Free	Free	Free	Free	Free	Stop	Stop	Stop	Stop	Stop	Stop
RT Channelized	-	-	None	-	-	None	-	-	None	-	-	None
Storage Length	105	-	-	170	-	-	-	-	-	-	-	-
Veh in Median Storage, #	-	0	-	-	0	-	-	0	-	-	0	-
Grade, %	-	0	-	-	0	-	-	0	-	-	0	-
Peak Hour Factor	92	92	92	92	92	92	92	92	92	92	92	92
Heavy Vehicles, %	2	2	2	2	2	2	2	2	2	2	2	2
Mvmt Flow	16	77	25	1	109	12	35	0	1	2	0	12

























Major/Minor	Major1			Major2			Minor1			Minor2		
Conflicting Flow All	121	0	0	102	0	0	245	245	90	239	251	115
Stage 1	-	-	-	-	-	-	122	122	-	117	117	-
Stage 2	-	-	-	-	-	-	123	123	-	122	134	-
Critical Hdwy	4.12	-	-	4.12	-	-	7.12	6.52	6.22	7.12	6.52	6.22
Critical Hdwy Stg 1	-	-	-	-	-	-	6.12	5.52	-	6.12	5.52	-
Critical Hdwy Stg 2	-	-	-	-	-	-	6.12	5.52	-	6.12	5.52	-
Follow-up Hdwy	2.218	-	-	2.218	-	-	3.518	4.018	3.318	3.518	4.018	3.318
Pot Cap-1 Maneuver	1467	-	-	1490	-	-	709	657	968	715	652	937
Stage 1	-	-	-	-	-	-	882	795	-	888	799	-
Stage 2	-	-	-	-	-	-	881	794	-	882	785	-
Platoon blocked, %	-	-	-	-	-	-	-	-	-	-	-	-
Mov Cap-1 Maneuver	1467	-	-	1490	-	-	694	649	968	708	644	937
Mov Cap-2 Maneuver	-	-	-	-	-	-	694	649	-	708	644	-
Stage 1	-	-	-	-	-	-	872	786	-	878	798	-
Stage 2	-	-	-	-	-	-	869	793	-	871	776	-

Approach	EB			WB			NB			SB		
HCM Control Delay, s	1			0.1			10.4			9.1		
HCM LOS							B			A		

Minor Lane/Major Mvmt	NBLn1	EBL	EBT	EBR	WBL	WBT	WBR	SBLn1
Capacity (veh/h)	700	1467	-	-	1490	-	-	893
HCM Lane V/C Ratio	0.051	0.011	-	-	0.001	-	-	0.016
HCM Control Delay (s)	10.4	7.5	-	-	7.4	-	-	9.1
HCM Lane LOS	B	A	-	-	A	-	-	A
HCM 95th %tile Q(veh)	0.2	0	-	-	0	-	-	0

Timings
1: S Union Boulevard & Eastlake Boulevard

Existing Traffic Conditions
PM Peak Hour

												
Lane Group	EBL	EBT	EBR	WBL	WBT	WBR	NBL	NBT	NBR	SBL	SBT	SBR
Lane Configurations												
Traffic Volume (vph)	54	76	17	51	56	13	10	589	25	32	747	53
Future Volume (vph)	54	76	17	51	56	13	10	589	25	32	747	53
Satd. Flow (prot)	1770	1863	1583	1770	1863	1583	1770	3518	0	1770	3539	1583
Flt Permitted	0.717			0.703			0.343			0.398		
Satd. Flow (perm)	1336	1863	1583	1310	1863	1583	639	3518	0	741	3539	1583
Satd. Flow (RTOR)			45			45		10				55
Lane Group Flow (vph)	59	83	18	55	61	14	11	667	0	35	812	58
Turn Type	Perm	NA	Perm	Perm	NA	Perm	Perm	NA		Perm	NA	Perm
Protected Phases		4			8			2			6	
Permitted Phases	4		4	8		8	2			6		6
Detector Phase	4	4	4	8	8	8	2	2		6	6	6
Switch Phase												
Minimum Initial (s)	4.0	4.0	4.0	4.0	4.0	4.0	4.0	4.0		4.0	4.0	4.0
Minimum Split (s)	10.0	10.0	10.0	10.0	10.0	10.0	9.5	9.5		9.5	9.5	9.5
Total Split (s)	25.0	25.0	25.0	25.0	25.0	25.0	35.0	35.0		35.0	35.0	35.0
Total Split (%)	41.7%	41.7%	41.7%	41.7%	41.7%	41.7%	58.3%	58.3%		58.3%	58.3%	58.3%
Yellow Time (s)	4.0	4.0	4.0	4.0	4.0	4.0	3.5	3.5		3.5	3.5	3.5
All-Red Time (s)	2.0	2.0	2.0	2.0	2.0	2.0	2.0	2.0		2.0	2.0	2.0
Lost Time Adjust (s)	0.0	0.0	0.0	0.0	0.0	0.0	0.0	0.0		0.0	0.0	0.0
Total Lost Time (s)	6.0	6.0	6.0	6.0	6.0	6.0	5.5	5.5		5.5	5.5	5.5
Lead/Lag												
Lead-Lag Optimize?												
Recall Mode	None	None	None	None	None	None	C-Max	C-Max		C-Max	C-Max	C-Max
Act Effct Green (s)	8.2	8.2	8.2	8.2	8.2	8.2	43.7	43.7		43.7	43.7	43.7
Actuated g/C Ratio	0.14	0.14	0.14	0.14	0.14	0.14	0.73	0.73		0.73	0.73	0.73
v/c Ratio	0.32	0.33	0.07	0.31	0.24	0.05	0.02	0.26		0.06	0.32	0.05
Control Delay	27.4	26.1	3.2	27.1	24.5	1.7	4.3	4.2		4.5	4.5	1.7
Queue Delay	0.0	0.0	0.0	0.0	0.0	0.0	0.0	0.0		0.0	0.0	0.0
Total Delay	27.4	26.1	3.2	27.1	24.5	1.7	4.3	4.2		4.5	4.5	1.7
LOS	C	C	A	C	C	A	A	A		A	A	A
Approach Delay		24.0			23.1			4.2			4.4	
Approach LOS		C			C			A			A	
Queue Length 50th (ft)	20	28	0	18	20	0	1	40		3	52	0
Queue Length 95th (ft)	47	59	6	44	47	3	6	73		13	93	10
Internal Link Dist (ft)		416			208			351			547	
Turn Bay Length (ft)	65		60	40		40	100			125		30
Base Capacity (vph)	423	589	532	414	589	532	465	2564		539	2577	1168
Starvation Cap Reductn	0	0	0	0	0	0	0	0		0	0	0
Spillback Cap Reductn	0	0	0	0	0	0	0	0		0	0	0
Storage Cap Reductn	0	0	0	0	0	0	0	0		0	0	0
Reduced v/c Ratio	0.14	0.14	0.03	0.13	0.10	0.03	0.02	0.26		0.06	0.32	0.05
Intersection Summary												
Cycle Length: 60												
Actuated Cycle Length: 60												
Offset: 0 (0%), Referenced to phase 2:NBTL and 6:SBTL, Start of Green												
Natural Cycle: 40												
Control Type: Actuated-Coordinated												

Timings
 1: S Union Boulevard & Eastlake Boulevard

Existing Traffic Conditions
 PM Peak Hour

Maximum v/c Ratio: 0.33	
Intersection Signal Delay: 7.3	Intersection LOS: A
Intersection Capacity Utilization 45.8%	ICU Level of Service A
Analysis Period (min) 15	

Splits and Phases: 1: S Union Boulevard & Eastlake Boulevard

 Ø2 (R) 35 s	 Ø4 25 s
 Ø6 (R) 35 s	 Ø8 25 s

HCM 6th TWSC
2: S Union Boulevard & Airport Road

Existing Traffic Conditions
PM Peak Hour

Intersection						
Int Delay, s/veh	0.9					
Movement	WBL	WBR	NBT	NBR	SBL	SBT
Lane Configurations	↘	↗	↑↑	↗	↘	↑↑
Traffic Vol, veh/h	26	47	636	24	68	791
Future Vol, veh/h	26	47	636	24	68	791
Conflicting Peds, #/hr	0	0	0	0	0	0
Sign Control	Stop	Stop	Free	Free	Free	Free
RT Channelized	-	None	-	None	-	None
Storage Length	0	70	-	60	350	-
Veh in Median Storage, #	0	-	0	-	-	0
Grade, %	0	-	0	-	-	0
Peak Hour Factor	92	92	92	92	92	92
Heavy Vehicles, %	2	2	2	2	2	2
Mvmt Flow	28	51	691	26	74	860

Major/Minor	Minor1	Major1	Major2			
Conflicting Flow All	1269	346	0	0	717	0
Stage 1	691	-	-	-	-	-
Stage 2	578	-	-	-	-	-
Critical Hdwy	6.84	6.94	-	-	4.14	-
Critical Hdwy Stg 1	5.84	-	-	-	-	-
Critical Hdwy Stg 2	5.84	-	-	-	-	-
Follow-up Hdwy	3.52	3.32	-	-	2.22	-
Pot Cap-1 Maneuver	245	*865	-	-	1149	-
Stage 1	721	-	-	-	-	-
Stage 2	524	-	-	-	-	-
Platoon blocked, %	1	1	-	-	1	-
Mov Cap-1 Maneuver	230	*865	-	-	1149	-
Mov Cap-2 Maneuver	365	-	-	-	-	-
Stage 1	721	-	-	-	-	-
Stage 2	490	-	-	-	-	-

Approach	WB	NB	SB
HCM Control Delay, s	11.6	0	0.7
HCM LOS	B		

Minor Lane/Major Mvmt	NBT	NBR	WBLn1	WBLn2	SBL	SBT
Capacity (veh/h)	-	-	365	865	1149	-
HCM Lane V/C Ratio	-	-	0.077	0.059	0.064	-
HCM Control Delay (s)	-	-	15.7	9.4	8.3	-
HCM Lane LOS	-	-	C	A	A	-
HCM 95th %tile Q(veh)	-	-	0.2	0.2	0.2	-

Notes
 ~: Volume exceeds capacity \$: Delay exceeds 300s +: Computation Not Defined *: All major volume in platoon

HCM 6th TWSC
3: Eastlake Boulevard & Airport Road

Existing Traffic Conditions
PM Peak Hour

Intersection						
Int Delay, s/veh	4.7					
Movement	EBT	EBR	WBL	WBT	NEL	NER
Lane Configurations	↔		↔	↑	↔	↔
Traffic Vol, veh/h	85	11	98	73	4	106
Future Vol, veh/h	85	11	98	73	4	106
Conflicting Peds, #/hr	0	0	0	0	0	0
Sign Control	Free	Free	Free	Free	Stop	Stop
RT Channelized	-	None	-	None	-	None
Storage Length	-	-	400	-	80	-
Veh in Median Storage, #	0	-	-	0	0	-
Grade, %	0	-	-	0	0	-
Peak Hour Factor	92	92	92	92	92	92
Heavy Vehicles, %	2	2	2	2	2	2
Mvmt Flow	92	12	107	79	4	115

Major/Minor	Major1	Major2	Minor1		
Conflicting Flow All	0	0	104	0	391 98
Stage 1	-	-	-	-	98 -
Stage 2	-	-	-	-	293 -
Critical Hdwy	-	-	4.12	-	6.42 6.22
Critical Hdwy Stg 1	-	-	-	-	5.42 -
Critical Hdwy Stg 2	-	-	-	-	5.42 -
Follow-up Hdwy	-	-	2.218	-	3.518 3.318
Pot Cap-1 Maneuver	-	-	1488	-	613 958
Stage 1	-	-	-	-	926 -
Stage 2	-	-	-	-	757 -
Platoon blocked, %	-	-	-	-	-
Mov Cap-1 Maneuver	-	-	1488	-	569 958
Mov Cap-2 Maneuver	-	-	-	-	569 -
Stage 1	-	-	-	-	926 -
Stage 2	-	-	-	-	702 -

Approach	EB	WB	NE
HCM Control Delay, s	0	4.4	9.4
HCM LOS			A

Minor Lane/Major Mvmt	NELn1	NELn2	EBT	EBR	WBL	WBT
Capacity (veh/h)	569	958	-	-	1488	-
HCM Lane V/C Ratio	0.008	0.12	-	-	0.072	-
HCM Control Delay (s)	11.4	9.3	-	-	7.6	-
HCM Lane LOS	B	A	-	-	A	-
HCM 95th %tile Q(veh)	0	0.4	-	-	0.2	-

HCM 6th TWSC
4: Eastlake Boulevard & Salt Drive

Existing Traffic Conditions
PM Peak Hour

Intersection						
Int Delay, s/veh	0.3					
Movement	NWL	NWR	NET	NER	SWL	SWT
Lane Configurations	T		T		T	
Traffic Vol, veh/h	4	3	104	3	2	107
Future Vol, veh/h	4	3	104	3	2	107
Conflicting Peds, #/hr	0	0	0	0	0	0
Sign Control	Stop	Stop	Free	Free	Free	Free
RT Channelized	-	None	-	None	-	None
Storage Length	0	-	-	-	-	-
Veh in Median Storage, #	0	-	0	-	-	0
Grade, %	0	-	0	-	-	0
Peak Hour Factor	92	92	92	92	92	92
Heavy Vehicles, %	2	2	2	2	2	2
Mvmt Flow	4	3	113	3	2	116

Major/Minor	Minor1	Major1	Major2			
Conflicting Flow All	235	115	0	0	116	0
Stage 1	115	-	-	-	-	-
Stage 2	120	-	-	-	-	-
Critical Hdwy	6.42	6.22	-	-	4.12	-
Critical Hdwy Stg 1	5.42	-	-	-	-	-
Critical Hdwy Stg 2	5.42	-	-	-	-	-
Follow-up Hdwy	3.518	3.318	-	-	2.218	-
Pot Cap-1 Maneuver	753	937	-	-	1473	-
Stage 1	910	-	-	-	-	-
Stage 2	905	-	-	-	-	-
Platoon blocked, %			-	-		-
Mov Cap-1 Maneuver	752	937	-	-	1473	-
Mov Cap-2 Maneuver	757	-	-	-	-	-
Stage 1	910	-	-	-	-	-
Stage 2	904	-	-	-	-	-

Approach	NW	NE	SW
HCM Control Delay, s	9.4	0	0.1
HCM LOS	A		

Minor Lane/Major Mvmt	NET	NERNWLn1	SWL	SWT
Capacity (veh/h)	-	-	825	1473
HCM Lane V/C Ratio	-	-	0.009	0.001
HCM Control Delay (s)	-	-	9.4	7.4
HCM Lane LOS	-	-	A	A
HCM 95th %tile Q(veh)	-	-	0	0

HCM 6th TWSC
5: Eastlake Boulevard & Huron Road

Existing Traffic Conditions
PM Peak Hour

Intersection						
Int Delay, s/veh	0.5					
Movement	WBL	WBR	NET	NER	SWL	SWT
Lane Configurations	↔		↔		↔	↔
Traffic Vol, veh/h	4	1	106	9	7	104
Future Vol, veh/h	4	1	106	9	7	104
Conflicting Peds, #/hr	0	0	0	0	0	0
Sign Control	Stop	Stop	Free	Free	Free	Free
RT Channelized	-	None	-	None	-	None
Storage Length	0	-	-	-	200	-
Veh in Median Storage, #	0	-	0	-	-	0
Grade, %	0	-	0	-	-	0
Peak Hour Factor	92	92	92	92	92	92
Heavy Vehicles, %	2	2	2	2	2	2
Mvmt Flow	4	1	115	10	8	113

Major/Minor	Minor1	Major1	Major2			
Conflicting Flow All	249	120	0	0	125	0
Stage 1	120	-	-	-	-	-
Stage 2	129	-	-	-	-	-
Critical Hdwy	6.42	6.22	-	-	4.12	-
Critical Hdwy Stg 1	5.42	-	-	-	-	-
Critical Hdwy Stg 2	5.42	-	-	-	-	-
Follow-up Hdwy	3.518	3.318	-	-	2.218	-
Pot Cap-1 Maneuver	739	931	-	-	1462	-
Stage 1	905	-	-	-	-	-
Stage 2	897	-	-	-	-	-
Platoon blocked, %			-	-	-	-
Mov Cap-1 Maneuver	735	931	-	-	1462	-
Mov Cap-2 Maneuver	735	-	-	-	-	-
Stage 1	905	-	-	-	-	-
Stage 2	893	-	-	-	-	-

Approach	WB	NE	SW
HCM Control Delay, s	9.7	0	0.5
HCM LOS	A		

Minor Lane/Major Mvmt	NET	NERWBLn1	SWL	SWT
Capacity (veh/h)	-	-	767	1462
HCM Lane V/C Ratio	-	-	0.007	0.005
HCM Control Delay (s)	-	-	9.7	7.5
HCM Lane LOS	-	-	A	A
HCM 95th %tile Q(veh)	-	-	0	0

HCM 6th TWSC
6: Eastlake Boulevard & Erie Road

Existing Traffic Conditions
PM Peak Hour

Intersection						
Int Delay, s/veh	0.3					
Movement	NWL	NWR	NET	NER	SWL	SWT
Lane Configurations						
Traffic Vol, veh/h	4	2	113	7	2	106
Future Vol, veh/h	4	2	113	7	2	106
Conflicting Peds, #/hr	0	0	0	0	0	0
Sign Control	Stop	Stop	Free	Free	Free	Free
RT Channelized	-	None	-	None	-	None
Storage Length	0	-	-	-	180	-
Veh in Median Storage, #	0	-	0	-	-	0
Grade, %	0	-	0	-	-	0
Peak Hour Factor	92	92	92	92	92	92
Heavy Vehicles, %	2	2	2	2	2	2
Mvmt Flow	4	2	123	8	2	115

Major/Minor	Minor1	Major1	Major2		
Conflicting Flow All	246	127	0	0	131
Stage 1	127	-	-	-	-
Stage 2	119	-	-	-	-
Critical Hdwy	6.42	6.22	-	-	4.12
Critical Hdwy Stg 1	5.42	-	-	-	-
Critical Hdwy Stg 2	5.42	-	-	-	-
Follow-up Hdwy	3.518	3.318	-	-	2.218
Pot Cap-1 Maneuver	742	923	-	-	1454
Stage 1	899	-	-	-	-
Stage 2	906	-	-	-	-
Platoon blocked, %			-	-	-
Mov Cap-1 Maneuver	741	923	-	-	1454
Mov Cap-2 Maneuver	750	-	-	-	-
Stage 1	899	-	-	-	-
Stage 2	905	-	-	-	-

Approach	NW	NE	SW
HCM Control Delay, s	9.5	0	0.1
HCM LOS	A		

Minor Lane/Major Mvmt	NET	NER	NWLn1	SWL	SWT
Capacity (veh/h)	-	-	800	1454	-
HCM Lane V/C Ratio	-	-	0.008	0.001	-
HCM Control Delay (s)	-	-	9.5	7.5	-
HCM Lane LOS	-	-	A	A	-
HCM 95th %tile Q(veh)	-	-	0	0	-

HCM 6th TWSC
7: Manitoba Drive/Access A & Eastlake Boulevard

Existing Traffic Conditions
PM Peak Hour

Intersection												
Int Delay, s/veh	1.1											
Movement	EBL	EBT	EBR	WBL	WBT	WBR	NBL	NBT	NBR	SBL	SBT	SBR
Lane Configurations	↖	↗		↖	↗			↔			↔	
Traffic Vol, veh/h	1	111	21	2	105	3	10	0	2	7	0	9
Future Vol, veh/h	1	111	21	2	105	3	10	0	2	7	0	9
Conflicting Peds, #/hr	0	0	0	0	0	0	0	0	0	0	0	0
Sign Control	Free	Free	Free	Free	Free	Free	Stop	Stop	Stop	Stop	Stop	Stop
RT Channelized	-	-	None	-	-	None	-	-	None	-	-	None
Storage Length	105	-	-	170	-	-	-	-	-	-	-	-
Veh in Median Storage, #	-	0	-	-	0	-	-	0	-	-	0	-
Grade, %	-	0	-	-	0	-	-	0	-	-	0	-
Peak Hour Factor	92	92	92	92	92	92	92	92	92	92	92	92
Heavy Vehicles, %	2	2	2	2	2	2	2	2	2	2	2	2
Mvmt Flow	1	121	23	2	114	3	11	0	2	8	0	10

























Major/Minor	Major1			Major2			Minor1			Minor2		
Conflicting Flow All	117	0	0	144	0	0	260	256	133	256	266	116
Stage 1	-	-	-	-	-	-	135	135	-	120	120	-
Stage 2	-	-	-	-	-	-	125	121	-	136	146	-
Critical Hdwy	4.12	-	-	4.12	-	-	7.12	6.52	6.22	7.12	6.52	6.22
Critical Hdwy Stg 1	-	-	-	-	-	-	6.12	5.52	-	6.12	5.52	-
Critical Hdwy Stg 2	-	-	-	-	-	-	6.12	5.52	-	6.12	5.52	-
Follow-up Hdwy	2.218	-	-	2.218	-	-	3.518	4.018	3.318	3.518	4.018	3.318
Pot Cap-1 Maneuver	1471	-	-	1438	-	-	693	648	916	697	640	936
Stage 1	-	-	-	-	-	-	868	785	-	884	796	-
Stage 2	-	-	-	-	-	-	879	796	-	867	776	-
Platoon blocked, %	-	-	-	-	-	-	-	-	-	-	-	-
Mov Cap-1 Maneuver	1471	-	-	1438	-	-	685	647	916	694	639	936
Mov Cap-2 Maneuver	-	-	-	-	-	-	685	647	-	694	639	-
Stage 1	-	-	-	-	-	-	867	784	-	883	795	-
Stage 2	-	-	-	-	-	-	869	795	-	864	775	-

Approach	EB			WB			NB			SB		
HCM Control Delay, s	0.1			0.1			10.1			9.5		
HCM LOS							B			A		

Minor Lane/Major Mvmt	NBLn1	EBL	EBT	EBR	WBL	WBT	WBR	SBLn1
Capacity (veh/h)	715	1471	-	-	1438	-	-	812
HCM Lane V/C Ratio	0.018	0.001	-	-	0.002	-	-	0.021
HCM Control Delay (s)	10.1	7.4	-	-	7.5	-	-	9.5
HCM Lane LOS	B	A	-	-	A	-	-	A
HCM 95th %tile Q(veh)	0.1	0	-	-	0	-	-	0.1

Timings
1: S Union Boulevard & Eastlake Boulevard

Background Traffic Conditions
AM Peak Hour - Year 2026

												
Lane Group	EBL	EBT	EBR	WBL	WBT	WBR	NBL	NBT	NBR	SBL	SBT	SBR
Lane Configurations												
Traffic Volume (vph)	39	63	21	55	63	28	11	785	36	14	459	32
Future Volume (vph)	39	63	21	55	63	28	11	785	36	14	459	32
Satd. Flow (prot)	1770	1863	1583	1770	1863	1583	1770	3514	0	1770	3539	1583
Flt Permitted	0.713			0.713			0.469			0.311		
Satd. Flow (perm)	1328	1863	1583	1328	1863	1583	874	3514	0	579	3539	1583
Satd. Flow (RTOR)			45			45		11				55
Lane Group Flow (vph)	42	68	23	60	68	30	12	892	0	15	499	35
Turn Type	Perm	NA	Perm	Perm	NA	Perm	Perm	NA		Perm	NA	Perm
Protected Phases		4			8			2			6	
Permitted Phases	4		4	8		8	2			6		6
Detector Phase	4	4	4	8	8	8	2	2		6	6	6
Switch Phase												
Minimum Initial (s)	4.0	4.0	4.0	4.0	4.0	4.0	4.0	4.0		4.0	4.0	4.0
Minimum Split (s)	10.0	10.0	10.0	10.0	10.0	10.0	9.5	9.5		9.5	9.5	9.5
Total Split (s)	25.0	25.0	25.0	25.0	25.0	25.0	35.0	35.0		35.0	35.0	35.0
Total Split (%)	41.7%	41.7%	41.7%	41.7%	41.7%	41.7%	58.3%	58.3%		58.3%	58.3%	58.3%
Yellow Time (s)	4.0	4.0	4.0	4.0	4.0	4.0	3.5	3.5		3.5	3.5	3.5
All-Red Time (s)	2.0	2.0	2.0	2.0	2.0	2.0	2.0	2.0		2.0	2.0	2.0
Lost Time Adjust (s)	0.0	0.0	0.0	0.0	0.0	0.0	0.0	0.0		0.0	0.0	0.0
Total Lost Time (s)	6.0	6.0	6.0	6.0	6.0	6.0	5.5	5.5		5.5	5.5	5.5
Lead/Lag												
Lead-Lag Optimize?												
Recall Mode	None	None	None	None	None	None	C-Max	C-Max		C-Max	C-Max	C-Max
Act Effct Green (s)	8.2	8.2	8.2	8.2	8.2	8.2	43.7	43.7		43.7	43.7	43.7
Actuated g/C Ratio	0.14	0.14	0.14	0.14	0.14	0.14	0.73	0.73		0.73	0.73	0.73
v/c Ratio	0.23	0.27	0.09	0.33	0.27	0.12	0.02	0.35		0.04	0.19	0.03
Control Delay	25.2	24.9	4.4	27.5	24.9	6.3	4.2	4.7		4.4	4.0	1.0
Queue Delay	0.0	0.0	0.0	0.0	0.0	0.0	0.0	0.0		0.0	0.0	0.0
Total Delay	25.2	24.9	4.4	27.5	24.9	6.3	4.2	4.7		4.4	4.0	1.0
LOS	C	C	A	C	C	A	A	A		A	A	A
Approach Delay		21.4			22.4			4.7			3.9	
Approach LOS		C			C			A			A	
Queue Length 50th (ft)	14	23	0	20	23	0	1	58		1	28	0
Queue Length 95th (ft)	37	50	9	47	50	14	6	104		8	54	5
Internal Link Dist (ft)		416			208			351			547	
Turn Bay Length (ft)	65		60	40		40	100			125		30
Base Capacity (vph)	420	589	532	420	589	532	636	2561		421	2576	1167
Starvation Cap Reductn	0	0	0	0	0	0	0	0		0	0	0
Spillback Cap Reductn	0	0	0	0	0	0	0	0		0	0	0
Storage Cap Reductn	0	0	0	0	0	0	0	0		0	0	0
Reduced v/c Ratio	0.10	0.12	0.04	0.14	0.12	0.06	0.02	0.35		0.04	0.19	0.03
Intersection Summary												
Cycle Length: 60												
Actuated Cycle Length: 60												
Offset: 0 (0%), Referenced to phase 2:NBTL and 6:SBTL, Start of Green												
Natural Cycle: 40												
Control Type: Actuated-Coordinated												

Timings
 1: S Union Boulevard & Eastlake Boulevard

Background Traffic Conditions
 AM Peak Hour - Year 2026

Maximum v/c Ratio: 0.35	
Intersection Signal Delay: 7.3	Intersection LOS: A
Intersection Capacity Utilization 44.1%	ICU Level of Service A
Analysis Period (min) 15	

Splits and Phases: 1: S Union Boulevard & Eastlake Boulevard

 Ø2 (R) 35 s	 Ø4 25 s
 Ø6 (R) 35 s	 Ø8 25 s

HCM 6th TWSC
2: S Union Boulevard & Airport Road

Background Traffic Conditions
AM Peak Hour - Year 2026

Intersection						
Int Delay, s/veh	0.9					
Movement	WBL	WBR	NBT	NBR	SBL	SBT
Lane Configurations	↘	↗	↑↑	↗	↘	↑↑
Traffic Vol, veh/h	22	69	825	24	37	518
Future Vol, veh/h	22	69	825	24	37	518
Conflicting Peds, #/hr	0	0	0	0	0	0
Sign Control	Stop	Stop	Free	Free	Free	Free
RT Channelized	-	None	-	None	-	None
Storage Length	0	70	-	60	350	-
Veh in Median Storage, #	0	-	0	-	-	0
Grade, %	0	-	0	-	-	0
Peak Hour Factor	92	92	92	92	92	92
Heavy Vehicles, %	2	2	2	2	2	2
Mvmt Flow	24	75	897	26	40	563

Major/Minor	Minor1	Major1	Major2		
Conflicting Flow All	1259	449	0	0	923
Stage 1	897	-	-	-	-
Stage 2	362	-	-	-	-
Critical Hdwy	6.84	6.94	-	-	4.14
Critical Hdwy Stg 1	5.84	-	-	-	-
Critical Hdwy Stg 2	5.84	-	-	-	-
Follow-up Hdwy	3.52	3.32	-	-	2.22
Pot Cap-1 Maneuver	339	*762	-	-	1095
Stage 1	710	-	-	-	-
Stage 2	675	-	-	-	-
Platoon blocked, %	1	1	-	-	1
Mov Cap-1 Maneuver	326	*762	-	-	1095
Mov Cap-2 Maneuver	458	-	-	-	-
Stage 1	710	-	-	-	-
Stage 2	650	-	-	-	-

Approach	WB	NB	SB
HCM Control Delay, s	10.9	0	0.6
HCM LOS	B		

Minor Lane/Major Mvmt	NBT	NBR	WBLn1	WBLn2	SBL	SBT
Capacity (veh/h)	-	-	458	762	1095	-
HCM Lane V/C Ratio	-	-	0.052	0.098	0.037	-
HCM Control Delay (s)	-	-	13.3	10.2	8.4	-
HCM Lane LOS	-	-	B	B	A	-
HCM 95th %tile Q(veh)	-	-	0.2	0.3	0.1	-

Notes
 ~: Volume exceeds capacity \$: Delay exceeds 300s +: Computation Not Defined *: All major volume in platoon

HCM 6th TWSC
3: Eastlake Boulevard & Airport Road

Background Traffic Conditions
AM Peak Hour - Year 2026

Intersection						
Int Delay, s/veh	4.7					
Movement	EBT	EBR	WBL	WBT	NEL	NER
Lane Configurations	↔		↔	↑	↔	↔
Traffic Vol, veh/h	55	2	102	81	7	75
Future Vol, veh/h	55	2	102	81	7	75
Conflicting Peds, #/hr	0	0	0	0	0	0
Sign Control	Free	Free	Free	Free	Stop	Stop
RT Channelized	-	None	-	None	-	None
Storage Length	-	-	400	-	80	-
Veh in Median Storage, #	0	-	-	0	0	-
Grade, %	0	-	-	0	0	-
Peak Hour Factor	92	92	92	92	92	92
Heavy Vehicles, %	2	2	2	2	2	2
Mvmt Flow	60	2	111	88	8	82

Major/Minor	Major1	Major2	Minor1			
Conflicting Flow All	0	0	62	0	371	61
Stage 1	-	-	-	-	61	-
Stage 2	-	-	-	-	310	-
Critical Hdwy	-	-	4.12	-	6.42	6.22
Critical Hdwy Stg 1	-	-	-	-	5.42	-
Critical Hdwy Stg 2	-	-	-	-	5.42	-
Follow-up Hdwy	-	-	2.218	-	3.518	3.318
Pot Cap-1 Maneuver	-	-	1541	-	630	1004
Stage 1	-	-	-	-	962	-
Stage 2	-	-	-	-	744	-
Platoon blocked, %	-	-	-	-	-	-
Mov Cap-1 Maneuver	-	-	1541	-	585	1004
Mov Cap-2 Maneuver	-	-	-	-	585	-
Stage 1	-	-	-	-	962	-
Stage 2	-	-	-	-	690	-

Approach	EB	WB	NE
HCM Control Delay, s	0	4.2	9.1
HCM LOS			A

Minor Lane/Major Mvmt	NELn1	NELn2	EBT	EBR	WBL	WBT
Capacity (veh/h)	585	1004	-	-	1541	-
HCM Lane V/C Ratio	0.013	0.081	-	-	0.072	-
HCM Control Delay (s)	11.2	8.9	-	-	7.5	-
HCM Lane LOS	B	A	-	-	A	-
HCM 95th %tile Q(veh)	0	0.3	-	-	0.2	-

HCM 6th TWSC
4: Eastlake Boulevard & Salt Drive

Background Traffic Conditions
AM Peak Hour - Year 2026

Intersection						
Int Delay, s/veh	0.4					
Movement	NWL	NWR	NET	NER	SWL	SWT
Lane Configurations	↔		↔		↔	
Traffic Vol, veh/h	4	3	78	0	2	102
Future Vol, veh/h	4	3	78	0	2	102
Conflicting Peds, #/hr	0	0	0	0	0	0
Sign Control	Stop	Stop	Free	Free	Free	Free
RT Channelized	-	None	-	None	-	None
Storage Length	0	-	-	-	-	-
Veh in Median Storage, #	0	-	0	-	-	0
Grade, %	0	-	0	-	-	0
Peak Hour Factor	92	92	92	92	92	92
Heavy Vehicles, %	2	2	2	2	2	2
Mvmt Flow	4	3	85	0	2	111

Major/Minor	Minor1	Major1	Major2			
Conflicting Flow All	200	85	0	0	85	0
Stage 1	85	-	-	-	-	-
Stage 2	115	-	-	-	-	-
Critical Hdwy	6.42	6.22	-	-	4.12	-
Critical Hdwy Stg 1	5.42	-	-	-	-	-
Critical Hdwy Stg 2	5.42	-	-	-	-	-
Follow-up Hdwy	3.518	3.318	-	-	2.218	-
Pot Cap-1 Maneuver	789	974	-	-	1512	-
Stage 1	938	-	-	-	-	-
Stage 2	910	-	-	-	-	-
Platoon blocked, %			-	-		-
Mov Cap-1 Maneuver	788	974	-	-	1512	-
Mov Cap-2 Maneuver	780	-	-	-	-	-
Stage 1	938	-	-	-	-	-
Stage 2	909	-	-	-	-	-

Approach	NW	NE	SW
HCM Control Delay, s	9.3	0	0.1
HCM LOS	A		

Minor Lane/Major Mvmt	NET	NER	NWLn1	SWL	SWT
Capacity (veh/h)	-	-	853	1512	-
HCM Lane V/C Ratio	-	-	0.009	0.001	-
HCM Control Delay (s)	-	-	9.3	7.4	0
HCM Lane LOS	-	-	A	A	A
HCM 95th %tile Q(veh)	-	-	0	0	-

HCM 6th TWSC
5: Eastlake Boulevard & Huron Road

Background Traffic Conditions
AM Peak Hour - Year 2026

Intersection						
Int Delay, s/veh	0.7					
Movement	WBL	WBR	NET	NER	SWL	SWT
Lane Configurations	↔		↔		↔	↔
Traffic Vol, veh/h	7	6	72	5	1	105
Future Vol, veh/h	7	6	72	5	1	105
Conflicting Peds, #/hr	0	0	0	0	0	0
Sign Control	Stop	Stop	Free	Free	Free	Free
RT Channelized	-	None	-	None	-	None
Storage Length	0	-	-	-	200	-
Veh in Median Storage, #	0	-	0	-	-	0
Grade, %	0	-	0	-	-	0
Peak Hour Factor	92	92	92	92	92	92
Heavy Vehicles, %	2	2	2	2	2	2
Mvmt Flow	8	7	78	5	1	114

Major/Minor	Minor1	Major1	Major2		
Conflicting Flow All	197	81	0	0	83
Stage 1	81	-	-	-	-
Stage 2	116	-	-	-	-
Critical Hdwy	6.42	6.22	-	-	4.12
Critical Hdwy Stg 1	5.42	-	-	-	-
Critical Hdwy Stg 2	5.42	-	-	-	-
Follow-up Hdwy	3.518	3.318	-	-	2.218
Pot Cap-1 Maneuver	792	979	-	-	1514
Stage 1	942	-	-	-	-
Stage 2	909	-	-	-	-
Platoon blocked, %			-	-	-
Mov Cap-1 Maneuver	791	979	-	-	1514
Mov Cap-2 Maneuver	791	-	-	-	-
Stage 1	942	-	-	-	-
Stage 2	908	-	-	-	-

Approach	WB	NE	SW
HCM Control Delay, s	9.2	0	0.1
HCM LOS	A		

Minor Lane/Major Mvmt	NET	NERWBLn1	SWL	SWT
Capacity (veh/h)	-	-	868	1514
HCM Lane V/C Ratio	-	-	0.016	0.001
HCM Control Delay (s)	-	-	9.2	7.4
HCM Lane LOS	-	-	A	A
HCM 95th %tile Q(veh)	-	-	0.1	0

HCM 6th TWSC
6: Eastlake Boulevard & Erie Road

Background Traffic Conditions
AM Peak Hour - Year 2026

Intersection						
Int Delay, s/veh	0.4					
Movement	NWL	NWR	NET	NER	SWL	SWT
Lane Configurations	↔		↔		↔	↔
Traffic Vol, veh/h	5	3	74	3	1	111
Future Vol, veh/h	5	3	74	3	1	111
Conflicting Peds, #/hr	0	0	0	0	0	0
Sign Control	Stop	Stop	Free	Free	Free	Free
RT Channelized	-	None	-	None	-	None
Storage Length	0	-	-	-	180	-
Veh in Median Storage, #	0	-	0	-	-	0
Grade, %	0	-	0	-	-	0
Peak Hour Factor	92	92	92	92	92	92
Heavy Vehicles, %	2	2	2	2	2	2
Mvmt Flow	5	3	80	3	1	121

Major/Minor	Minor1	Major1	Major2			
Conflicting Flow All	205	82	0	0	83	0
Stage 1	82	-	-	-	-	-
Stage 2	123	-	-	-	-	-
Critical Hdwy	6.42	6.22	-	-	4.12	-
Critical Hdwy Stg 1	5.42	-	-	-	-	-
Critical Hdwy Stg 2	5.42	-	-	-	-	-
Follow-up Hdwy	3.518	3.318	-	-	2.218	-
Pot Cap-1 Maneuver	783	978	-	-	1514	-
Stage 1	941	-	-	-	-	-
Stage 2	902	-	-	-	-	-
Platoon blocked, %			-	-		-
Mov Cap-1 Maneuver	782	978	-	-	1514	-
Mov Cap-2 Maneuver	776	-	-	-	-	-
Stage 1	941	-	-	-	-	-
Stage 2	901	-	-	-	-	-

Approach	NW	NE	SW
HCM Control Delay, s	9.3	0	0.1
HCM LOS	A		

Minor Lane/Major Mvmt	NET	NERNWLn1	SWL	SWT
Capacity (veh/h)	-	-	841	1514
HCM Lane V/C Ratio	-	-	0.01	0.001
HCM Control Delay (s)	-	-	9.3	7.4
HCM Lane LOS	-	-	A	A
HCM 95th %tile Q(veh)	-	-	0	0

HCM 6th TWSC
7: Manitoba Drive/Access A & Eastlake Boulevard

Background Traffic Conditions
AM Peak Hour - Year 2026

Intersection												
Int Delay, s/veh	2.2											
Movement	EBL	EBT	EBR	WBL	WBT	WBR	NBL	NBT	NBR	SBL	SBT	SBR
Lane Configurations	↖	↗		↖	↗			↕			↕	
Traffic Vol, veh/h	16	74	24	1	104	11	33	0	1	2	0	11
Future Vol, veh/h	16	74	24	1	104	11	33	0	1	2	0	11
Conflicting Peds, #/hr	0	0	0	0	0	0	0	0	0	0	0	0
Sign Control	Free	Free	Free	Free	Free	Free	Stop	Stop	Stop	Stop	Stop	Stop
RT Channelized	-	-	None	-	-	None	-	-	None	-	-	None
Storage Length	105	-	-	170	-	-	-	-	-	-	-	-
Veh in Median Storage, #	-	0	-	-	0	-	-	0	-	-	0	-
Grade, %	-	0	-	-	0	-	-	0	-	-	0	-
Peak Hour Factor	92	92	92	92	92	92	92	92	92	92	92	92
Heavy Vehicles, %	2	2	2	2	2	2	2	2	2	2	2	2
Mvmt Flow	17	80	26	1	113	12	36	0	1	2	0	12

























Major/Minor	Major1			Major2			Minor1			Minor2		
Conflicting Flow All	125	0	0	106	0	0	254	254	93	249	261	119
Stage 1	-	-	-	-	-	-	127	127	-	121	121	-
Stage 2	-	-	-	-	-	-	127	127	-	128	140	-
Critical Hdwy	4.12	-	-	4.12	-	-	7.12	6.52	6.22	7.12	6.52	6.22
Critical Hdwy Stg 1	-	-	-	-	-	-	6.12	5.52	-	6.12	5.52	-
Critical Hdwy Stg 2	-	-	-	-	-	-	6.12	5.52	-	6.12	5.52	-
Follow-up Hdwy	2.218	-	-	2.218	-	-	3.518	4.018	3.318	3.518	4.018	3.318
Pot Cap-1 Maneuver	1462	-	-	1485	-	-	699	650	964	705	644	933
Stage 1	-	-	-	-	-	-	877	791	-	883	796	-
Stage 2	-	-	-	-	-	-	877	791	-	876	781	-
Platoon blocked, %	-	-	-	-	-	-	-	-	-	-	-	-
Mov Cap-1 Maneuver	1462	-	-	1485	-	-	684	642	964	698	636	933
Mov Cap-2 Maneuver	-	-	-	-	-	-	684	642	-	698	636	-
Stage 1	-	-	-	-	-	-	866	782	-	872	795	-
Stage 2	-	-	-	-	-	-	865	790	-	865	772	-

Approach	EB			WB			NB			SB		
HCM Control Delay, s	1.1			0.1			10.5			9.1		
HCM LOS							B			A		

Minor Lane/Major Mvmt	NBLn1	EBL	EBT	EBR	WBL	WBT	WBR	SBLn1
Capacity (veh/h)	690	1462	-	-	1485	-	-	887
HCM Lane V/C Ratio	0.054	0.012	-	-	0.001	-	-	0.016
HCM Control Delay (s)	10.5	7.5	-	-	7.4	-	-	9.1
HCM Lane LOS	B	A	-	-	A	-	-	A
HCM 95th %tile Q(veh)	0.2	0	-	-	0	-	-	0

Timings
1: S Union Boulevard & Eastlake Boulevard

Background Traffic Conditions
PM Peak Hour - Year 2026

												
Lane Group	EBL	EBT	EBR	WBL	WBT	WBR	NBL	NBT	NBR	SBL	SBT	SBR
Lane Configurations												
Traffic Volume (vph)	56	79	18	53	58	14	10	613	26	33	777	55
Future Volume (vph)	56	79	18	53	58	14	10	613	26	33	777	55
Satd. Flow (prot)	1770	1863	1583	1770	1863	1583	1770	3518	0	1770	3539	1583
Flt Permitted	0.716			0.701			0.329			0.388		
Satd. Flow (perm)	1334	1863	1583	1306	1863	1583	613	3518	0	723	3539	1583
Satd. Flow (RTOR)			45			45		10				55
Lane Group Flow (vph)	61	86	20	58	63	15	11	694	0	36	845	60
Turn Type	Perm	NA	Perm	Perm	NA	Perm	Perm	NA		Perm	NA	Perm
Protected Phases		4			8			2			6	
Permitted Phases	4		4	8		8	2			6		6
Detector Phase	4	4	4	8	8	8	2	2		6	6	6
Switch Phase												
Minimum Initial (s)	4.0	4.0	4.0	4.0	4.0	4.0	4.0	4.0		4.0	4.0	4.0
Minimum Split (s)	10.0	10.0	10.0	10.0	10.0	10.0	9.5	9.5		9.5	9.5	9.5
Total Split (s)	25.0	25.0	25.0	25.0	25.0	25.0	35.0	35.0		35.0	35.0	35.0
Total Split (%)	41.7%	41.7%	41.7%	41.7%	41.7%	41.7%	58.3%	58.3%		58.3%	58.3%	58.3%
Yellow Time (s)	4.0	4.0	4.0	4.0	4.0	4.0	3.5	3.5		3.5	3.5	3.5
All-Red Time (s)	2.0	2.0	2.0	2.0	2.0	2.0	2.0	2.0		2.0	2.0	2.0
Lost Time Adjust (s)	0.0	0.0	0.0	0.0	0.0	0.0	0.0	0.0		0.0	0.0	0.0
Total Lost Time (s)	6.0	6.0	6.0	6.0	6.0	6.0	5.5	5.5		5.5	5.5	5.5
Lead/Lag												
Lead-Lag Optimize?												
Recall Mode	None	None	None	None	None	None	C-Max	C-Max		C-Max	C-Max	C-Max
Act Effct Green (s)	8.3	8.3	8.3	8.3	8.3	8.3	43.6	43.6		43.6	43.6	43.6
Actuated g/C Ratio	0.14	0.14	0.14	0.14	0.14	0.14	0.73	0.73		0.73	0.73	0.73
v/c Ratio	0.33	0.33	0.08	0.32	0.25	0.06	0.02	0.27		0.07	0.33	0.05
Control Delay	27.4	26.1	3.6	27.3	24.4	2.0	4.4	4.3		4.6	4.7	1.8
Queue Delay	0.0	0.0	0.0	0.0	0.0	0.0	0.0	0.0		0.0	0.0	0.0
Total Delay	27.4	26.1	3.6	27.3	24.4	2.0	4.4	4.3		4.6	4.7	1.8
LOS	C	C	A	C	C	A	A	A		A	A	A
Approach Delay		23.9			23.2			4.3			4.5	
Approach LOS		C			C			A			A	
Queue Length 50th (ft)	20	29	0	19	21	0	1	42		4	55	1
Queue Length 95th (ft)	48	60	7	46	47	4	6	77		14	98	11
Internal Link Dist (ft)		416			208			351			547	
Turn Bay Length (ft)	65		60	40		40	100			125		30
Base Capacity (vph)	422	589	532	413	589	532	445	2559		525	2571	1165
Starvation Cap Reductn	0	0	0	0	0	0	0	0		0	0	0
Spillback Cap Reductn	0	0	0	0	0	0	0	0		0	0	0
Storage Cap Reductn	0	0	0	0	0	0	0	0		0	0	0
Reduced v/c Ratio	0.14	0.15	0.04	0.14	0.11	0.03	0.02	0.27		0.07	0.33	0.05
Intersection Summary												
Cycle Length: 60												
Actuated Cycle Length: 60												
Offset: 0 (0%), Referenced to phase 2:NBTL and 6:SBTL, Start of Green												
Natural Cycle: 40												
Control Type: Actuated-Coordinated												

Timings
 1: S Union Boulevard & Eastlake Boulevard

Background Traffic Conditions
 PM Peak Hour - Year 2026

Maximum v/c Ratio: 0.33	
Intersection Signal Delay: 7.4	Intersection LOS: A
Intersection Capacity Utilization 46.8%	ICU Level of Service A
Analysis Period (min) 15	

Splits and Phases: 1: S Union Boulevard & Eastlake Boulevard

 Ø2 (R) 35 s	 Ø4 25 s
 Ø6 (R) 35 s	 Ø8 25 s

HCM 6th TWSC
2: S Union Boulevard & Airport Road

Background Traffic Conditions
PM Peak Hour - Year 2026

Intersection						
Int Delay, s/veh	0.9					
Movement	WBL	WBR	NBT	NBR	SBL	SBT
Lane Configurations	↘	↗	↑↑	↗	↘	↑↑
Traffic Vol, veh/h	27	49	661	25	71	823
Future Vol, veh/h	27	49	661	25	71	823
Conflicting Peds, #/hr	0	0	0	0	0	0
Sign Control	Stop	Stop	Free	Free	Free	Free
RT Channelized	-	None	-	None	-	None
Storage Length	0	70	-	60	350	-
Veh in Median Storage, #	0	-	0	-	-	0
Grade, %	0	-	0	-	-	0
Peak Hour Factor	92	92	92	92	92	92
Heavy Vehicles, %	2	2	2	2	2	2
Mvmt Flow	29	53	718	27	77	895

Major/Minor	Minor1	Major1	Major2		
Conflicting Flow All	1320	359	0	0	745
Stage 1	718	-	-	-	-
Stage 2	602	-	-	-	-
Critical Hdwy	6.84	6.94	-	-	4.14
Critical Hdwy Stg 1	5.84	-	-	-	-
Critical Hdwy Stg 2	5.84	-	-	-	-
Follow-up Hdwy	3.52	3.32	-	-	2.22
Pot Cap-1 Maneuver	*255	*814	-	-	*1217
Stage 1	*768	-	-	-	-
Stage 2	*510	-	-	-	-
Platoon blocked, %	1	1	-	-	1
Mov Cap-1 Maneuver	*239	*814	-	-	*1217
Mov Cap-2 Maneuver	*368	-	-	-	-
Stage 1	*768	-	-	-	-
Stage 2	*478	-	-	-	-

Approach	WB	NB	SB
HCM Control Delay, s	11.8	0	0.6
HCM LOS	B		

Minor Lane/Major Mvmt	NBT	NBR	WBLn1	WBLn2	SBL	SBT
Capacity (veh/h)	-	-	368	814	*1217	-
HCM Lane V/C Ratio	-	-	0.08	0.065	0.063	-
HCM Control Delay (s)	-	-	15.6	9.7	8.2	-
HCM Lane LOS	-	-	C	A	A	-
HCM 95th %tile Q(veh)	-	-	0.3	0.2	0.2	-

Notes
 ~: Volume exceeds capacity \$: Delay exceeds 300s +: Computation Not Defined *: All major volume in platoon

HCM 6th TWSC
3: Eastlake Boulevard & Airport Road

Background Traffic Conditions
PM Peak Hour - Year 2026

Intersection						
Int Delay, s/veh	4.7					
Movement	EBT	EBR	WBL	WBT	NEL	NER
Lane Configurations	↶		↷	↶	↷	↷
Traffic Vol, veh/h	88	11	102	76	4	110
Future Vol, veh/h	88	11	102	76	4	110
Conflicting Peds, #/hr	0	0	0	0	0	0
Sign Control	Free	Free	Free	Free	Stop	Stop
RT Channelized	-	None	-	None	-	None
Storage Length	-	-	400	-	80	-
Veh in Median Storage, #	0	-	-	0	0	-
Grade, %	0	-	-	0	0	-
Peak Hour Factor	92	92	92	92	92	92
Heavy Vehicles, %	2	2	2	2	2	2
Mvmt Flow	96	12	111	83	4	120

Major/Minor	Major1	Major2	Minor1		
Conflicting Flow All	0	0	108	0	407
Stage 1	-	-	-	-	102
Stage 2	-	-	-	-	305
Critical Hdwy	-	-	4.12	-	6.42
Critical Hdwy Stg 1	-	-	-	-	5.42
Critical Hdwy Stg 2	-	-	-	-	5.42
Follow-up Hdwy	-	-	2.218	-	3.518
Pot Cap-1 Maneuver	-	-	1483	-	600
Stage 1	-	-	-	-	922
Stage 2	-	-	-	-	748
Platoon blocked, %	-	-	-	-	-
Mov Cap-1 Maneuver	-	-	1483	-	555
Mov Cap-2 Maneuver	-	-	-	-	555
Stage 1	-	-	-	-	922
Stage 2	-	-	-	-	692

Approach	EB	WB	NE
HCM Control Delay, s	0	4.4	9.4
HCM LOS			A

Minor Lane/Major Mvmt	NELn1	NELn2	EBT	EBR	WBL	WBT
Capacity (veh/h)	555	953	-	-	1483	-
HCM Lane V/C Ratio	0.008	0.125	-	-	0.075	-
HCM Control Delay (s)	11.5	9.3	-	-	7.6	-
HCM Lane LOS	B	A	-	-	A	-
HCM 95th %tile Q(veh)	0	0.4	-	-	0.2	-

HCM 6th TWSC
4: Eastlake Boulevard & Salt Drive

Background Traffic Conditions
PM Peak Hour - Year 2026

Intersection						
Int Delay, s/veh	0.3					
Movement	NWL	NWR	NET	NER	SWL	SWT
Lane Configurations	↘↙		↕		↗↖	
Traffic Vol, veh/h	4	3	108	3	2	111
Future Vol, veh/h	4	3	108	3	2	111
Conflicting Peds, #/hr	0	0	0	0	0	0
Sign Control	Stop	Stop	Free	Free	Free	Free
RT Channelized	-	None	-	None	-	None
Storage Length	0	-	-	-	-	-
Veh in Median Storage, #	0	-	0	-	-	0
Grade, %	0	-	0	-	-	0
Peak Hour Factor	92	92	92	92	92	92
Heavy Vehicles, %	2	2	2	2	2	2
Mvmt Flow	4	3	117	3	2	121

Major/Minor	Minor1	Major1	Major2			
Conflicting Flow All	244	119	0	0	120	0
Stage 1	119	-	-	-	-	-
Stage 2	125	-	-	-	-	-
Critical Hdwy	6.42	6.22	-	-	4.12	-
Critical Hdwy Stg 1	5.42	-	-	-	-	-
Critical Hdwy Stg 2	5.42	-	-	-	-	-
Follow-up Hdwy	3.518	3.318	-	-	2.218	-
Pot Cap-1 Maneuver	744	933	-	-	1468	-
Stage 1	906	-	-	-	-	-
Stage 2	901	-	-	-	-	-
Platoon blocked, %			-	-		-
Mov Cap-1 Maneuver	743	933	-	-	1468	-
Mov Cap-2 Maneuver	751	-	-	-	-	-
Stage 1	906	-	-	-	-	-
Stage 2	900	-	-	-	-	-

Approach	NW	NE	SW
HCM Control Delay, s	9.4	0	0.1
HCM LOS	A		

Minor Lane/Major Mvmt	NET	NER	NWLn1	SWL	SWT
Capacity (veh/h)	-	-	820	1468	-
HCM Lane V/C Ratio	-	-	0.009	0.001	-
HCM Control Delay (s)	-	-	9.4	7.5	0
HCM Lane LOS	-	-	A	A	A
HCM 95th %tile Q(veh)	-	-	0	0	-

HCM 6th TWSC
5: Eastlake Boulevard & Huron Road

Background Traffic Conditions
PM Peak Hour - Year 2026

Intersection						
Int Delay, s/veh	0.4					
Movement	WBL	WBR	NET	NER	SWL	SWT
Lane Configurations	↘↗		↖↗		↘↗	↖↗
Traffic Vol, veh/h	4	1	110	9	7	108
Future Vol, veh/h	4	1	110	9	7	108
Conflicting Peds, #/hr	0	0	0	0	0	0
Sign Control	Stop	Stop	Free	Free	Free	Free
RT Channelized	-	None	-	None	-	None
Storage Length	0	-	-	-	200	-
Veh in Median Storage, #	0	-	0	-	-	0
Grade, %	0	-	0	-	-	0
Peak Hour Factor	92	92	92	92	92	92
Heavy Vehicles, %	2	2	2	2	2	2
Mvmt Flow	4	1	120	10	8	117

Major/Minor	Minor1	Major1	Major2		
Conflicting Flow All	258	125	0	0	130
Stage 1	125	-	-	-	-
Stage 2	133	-	-	-	-
Critical Hdwy	6.42	6.22	-	-	4.12
Critical Hdwy Stg 1	5.42	-	-	-	-
Critical Hdwy Stg 2	5.42	-	-	-	-
Follow-up Hdwy	3.518	3.318	-	-	2.218
Pot Cap-1 Maneuver	731	926	-	-	1455
Stage 1	901	-	-	-	-
Stage 2	893	-	-	-	-
Platoon blocked, %			-	-	-
Mov Cap-1 Maneuver	727	926	-	-	1455
Mov Cap-2 Maneuver	727	-	-	-	-
Stage 1	901	-	-	-	-
Stage 2	889	-	-	-	-

Approach	WB	NE	SW
HCM Control Delay, s	9.8	0	0.5
HCM LOS	A		

Minor Lane/Major Mvmt	NET	NERWBLn1	SWL	SWT
Capacity (veh/h)	-	-	760	1455
HCM Lane V/C Ratio	-	-	0.007	0.005
HCM Control Delay (s)	-	-	9.8	7.5
HCM Lane LOS	-	-	A	A
HCM 95th %tile Q(veh)	-	-	0	0

Intersection						
Int Delay, s/veh	0.3					
Movement	NWL	NWR	NET	NER	SWL	SWT
Lane Configurations	↙↘		↖↗		↙	↗
Traffic Vol, veh/h	4	2	118	7	2	110
Future Vol, veh/h	4	2	118	7	2	110
Conflicting Peds, #/hr	0	0	0	0	0	0
Sign Control	Stop	Stop	Free	Free	Free	Free
RT Channelized	-	None	-	None	-	None
Storage Length	0	-	-	-	180	-
Veh in Median Storage, #	0	-	0	-	-	0
Grade, %	0	-	0	-	-	0
Peak Hour Factor	92	92	92	92	92	92
Heavy Vehicles, %	2	2	2	2	2	2
Mvmt Flow	4	2	128	8	2	120

Major/Minor	Minor1	Major1	Major2			
Conflicting Flow All	256	132	0	0	136	0
Stage 1	132	-	-	-	-	-
Stage 2	124	-	-	-	-	-
Critical Hdwy	6.42	6.22	-	-	4.12	-
Critical Hdwy Stg 1	5.42	-	-	-	-	-
Critical Hdwy Stg 2	5.42	-	-	-	-	-
Follow-up Hdwy	3.518	3.318	-	-	2.218	-
Pot Cap-1 Maneuver	733	917	-	-	1448	-
Stage 1	894	-	-	-	-	-
Stage 2	902	-	-	-	-	-
Platoon blocked, %			-	-		-
Mov Cap-1 Maneuver	732	917	-	-	1448	-
Mov Cap-2 Maneuver	744	-	-	-	-	-
Stage 1	894	-	-	-	-	-
Stage 2	901	-	-	-	-	-

Approach	NW	NE	SW
HCM Control Delay, s	9.6	0	0.1
HCM LOS	A		

Minor Lane/Major Mvmt	NET	NER	NWLn1	SWL	SWT
Capacity (veh/h)	-	-	794	1448	-
HCM Lane V/C Ratio	-	-	0.008	0.002	-
HCM Control Delay (s)	-	-	9.6	7.5	-
HCM Lane LOS	-	-	A	A	-
HCM 95th %tile Q(veh)	-	-	0	0	-

HCM 6th TWSC
7: Manitoba Drive/Access A & Eastlake Boulevard

Background Traffic Conditions
PM Peak Hour - Year 2026

Intersection												
Int Delay, s/veh	1.1											
Movement	EBL	EBT	EBR	WBL	WBT	WBR	NBL	NBT	NBR	SBL	SBT	SBR
Lane Configurations	↖	↗		↖	↗			↕			↕	
Traffic Vol, veh/h	1	115	22	2	109	3	10	0	2	7	0	9
Future Vol, veh/h	1	115	22	2	109	3	10	0	2	7	0	9
Conflicting Peds, #/hr	0	0	0	0	0	0	0	0	0	0	0	0
Sign Control	Free	Free	Free	Free	Free	Free	Stop	Stop	Stop	Stop	Stop	Stop
RT Channelized	-	-	None	-	-	None	-	-	None	-	-	None
Storage Length	105	-	-	170	-	-	-	-	-	-	-	-
Veh in Median Storage, #	-	0	-	-	0	-	-	0	-	-	0	-
Grade, %	-	0	-	-	0	-	-	0	-	-	0	-
Peak Hour Factor	92	92	92	92	92	92	92	92	92	92	92	92
Heavy Vehicles, %	2	2	2	2	2	2	2	2	2	2	2	2
Mvmt Flow	1	125	24	2	118	3	11	0	2	8	0	10

























Major/Minor	Major1			Major2			Minor1			Minor2		
Conflicting Flow All	121	0	0	149	0	0	268	264	137	264	275	120
Stage 1	-	-	-	-	-	-	139	139	-	124	124	-
Stage 2	-	-	-	-	-	-	129	125	-	140	151	-
Critical Hdwy	4.12	-	-	4.12	-	-	7.12	6.52	6.22	7.12	6.52	6.22
Critical Hdwy Stg 1	-	-	-	-	-	-	6.12	5.52	-	6.12	5.52	-
Critical Hdwy Stg 2	-	-	-	-	-	-	6.12	5.52	-	6.12	5.52	-
Follow-up Hdwy	2.218	-	-	2.218	-	-	3.518	4.018	3.318	3.518	4.018	3.318
Pot Cap-1 Maneuver	1467	-	-	1432	-	-	685	641	911	689	632	931
Stage 1	-	-	-	-	-	-	864	782	-	880	793	-
Stage 2	-	-	-	-	-	-	875	792	-	863	772	-
Platoon blocked, %	-	-	-	-	-	-	-	-	-	-	-	-
Mov Cap-1 Maneuver	1467	-	-	1432	-	-	677	640	911	686	631	931
Mov Cap-2 Maneuver	-	-	-	-	-	-	677	640	-	686	631	-
Stage 1	-	-	-	-	-	-	863	781	-	879	792	-
Stage 2	-	-	-	-	-	-	865	791	-	860	771	-

Approach	EB			WB			NB			SB		
HCM Control Delay, s	0.1			0.1			10.2			9.6		
HCM LOS							B			A		

Minor Lane/Major Mvmt	NBLn1	EBL	EBT	EBR	WBL	WBT	WBR	SBLn1
Capacity (veh/h)	707	1467	-	-	1432	-	-	805
HCM Lane V/C Ratio	0.018	0.001	-	-	0.002	-	-	0.022
HCM Control Delay (s)	10.2	7.5	-	-	7.5	-	-	9.6
HCM Lane LOS	B	A	-	-	A	-	-	A
HCM 95th %tile Q(veh)	0.1	0	-	-	0	-	-	0.1

Timings
1: S Union Boulevard & Eastlake Boulevard

Background Traffic Conditions
AM Peak Hour - Year 2044

												
Lane Group	EBL	EBT	EBR	WBL	WBT	WBR	NBL	NBT	NBR	SBL	SBT	SBR
Lane Configurations												
Traffic Volume (vph)	56	92	30	80	92	41	17	1133	53	20	662	47
Future Volume (vph)	56	92	30	80	92	41	17	1133	53	20	662	47
Satd. Flow (prot)	1770	1863	1583	1770	1863	1583	1770	3514	0	1770	3539	1583
Flt Permitted	0.692			0.692			0.378			0.182		
Satd. Flow (perm)	1289	1863	1583	1289	1863	1583	704	3514	0	339	3539	1583
Satd. Flow (RTOR)			45			45		15				55
Lane Group Flow (vph)	61	100	33	87	100	45	18	1290	0	22	720	51
Turn Type	Perm	NA	Perm	Perm	NA	Perm	Perm	NA		Perm	NA	Perm
Protected Phases		4			8			2			6	
Permitted Phases	4		4	8		8	2			6		6
Detector Phase	4	4	4	8	8	8	2	2		6	6	6
Switch Phase												
Minimum Initial (s)	4.0	4.0	4.0	4.0	4.0	4.0	4.0	4.0		4.0	4.0	4.0
Minimum Split (s)	10.0	10.0	10.0	10.0	10.0	10.0	9.5	9.5		9.5	9.5	9.5
Total Split (s)	17.0	17.0	17.0	17.0	17.0	17.0	43.0	43.0		43.0	43.0	43.0
Total Split (%)	28.3%	28.3%	28.3%	28.3%	28.3%	28.3%	71.7%	71.7%		71.7%	71.7%	71.7%
Yellow Time (s)	4.0	4.0	4.0	4.0	4.0	4.0	3.5	3.5		3.5	3.5	3.5
All-Red Time (s)	2.0	2.0	2.0	2.0	2.0	2.0	2.0	2.0		2.0	2.0	2.0
Lost Time Adjust (s)	0.0	0.0	0.0	0.0	0.0	0.0	0.0	0.0		0.0	0.0	0.0
Total Lost Time (s)	6.0	6.0	6.0	6.0	6.0	6.0	5.5	5.5		5.5	5.5	5.5
Lead/Lag												
Lead-Lag Optimize?												
Recall Mode	None	None	None	None	None	None	C-Max	C-Max		C-Max	C-Max	C-Max
Act Effct Green (s)	8.9	8.9	8.9	8.9	8.9	8.9	43.0	43.0		43.0	43.0	43.0
Actuated g/C Ratio	0.15	0.15	0.15	0.15	0.15	0.15	0.72	0.72		0.72	0.72	0.72
v/c Ratio	0.32	0.36	0.12	0.46	0.36	0.17	0.04	0.51		0.09	0.28	0.04
Control Delay	26.7	26.1	7.0	30.6	26.1	9.2	4.5	6.2		5.6	4.7	1.5
Queue Delay	0.0	0.0	0.0	0.0	0.0	0.0	0.0	0.0		0.0	0.0	0.0
Total Delay	26.7	26.1	7.0	30.6	26.1	9.2	4.5	6.2		5.6	4.7	1.5
LOS	C	C	A	C	C	A	A	A		A	A	A
Approach Delay		23.0			24.5			6.2			4.5	
Approach LOS		C			C			A			A	
Queue Length 50th (ft)	20	33	0	29	33	0	2	108		2	48	0
Queue Length 95th (ft)	49	69	16	65	69	23	8	170		11	78	9
Internal Link Dist (ft)		416			208			351			547	
Turn Bay Length (ft)	65		60	40		40	100			125		30
Base Capacity (vph)	236	341	326	236	341	326	504	2523		243	2537	1150
Starvation Cap Reductn	0	0	0	0	0	0	0	0		0	0	0
Spillback Cap Reductn	0	0	0	0	0	0	0	0		0	0	0
Storage Cap Reductn	0	0	0	0	0	0	0	0		0	0	0
Reduced v/c Ratio	0.26	0.29	0.10	0.37	0.29	0.14	0.04	0.51		0.09	0.28	0.04

Intersection Summary





Cycle Length: 60
 Actuated Cycle Length: 60
 Offset: 0 (0%), Referenced to phase 2:NBTL and 6:SBTL, Start of Green
 Natural Cycle: 40
 Control Type: Actuated-Coordinated

Timings
 1: S Union Boulevard & Eastlake Boulevard

Background Traffic Conditions
 AM Peak Hour - Year 2044

Maximum v/c Ratio: 0.51	
Intersection Signal Delay: 8.6	Intersection LOS: A
Intersection Capacity Utilization 54.3%	ICU Level of Service A
Analysis Period (min) 15	

Splits and Phases: 1: S Union Boulevard & Eastlake Boulevard

 Ø2 (R) 43 s	 Ø4 17 s
 Ø6 (R) 43 s	 Ø8 17 s

HCM 6th TWSC
2: S Union Boulevard & Airport Road

Background Traffic Conditions
AM Peak Hour - Year 2044

Intersection						
Int Delay, s/veh	1					
Movement	WBL	WBR	NBT	NBR	SBL	SBT
Lane Configurations	↘	↗	↑↑	↗	↘	↑↑
Traffic Vol, veh/h	32	99	1190	35	54	747
Future Vol, veh/h	32	99	1190	35	54	747
Conflicting Peds, #/hr	0	0	0	0	0	0
Sign Control	Stop	Stop	Free	Free	Free	Free
RT Channelized	-	None	-	None	-	None
Storage Length	0	70	-	60	350	-
Veh in Median Storage, #	0	-	0	-	-	0
Grade, %	0	-	0	-	-	0
Peak Hour Factor	92	92	92	92	92	92
Heavy Vehicles, %	2	2	2	2	2	2
Mvmt Flow	35	108	1293	38	59	812

Major/Minor	Minor1	Major1	Major2		
Conflicting Flow All	1817	647	0	0	1331
Stage 1	1293	-	-	-	-
Stage 2	524	-	-	-	-
Critical Hdwy	6.84	6.94	-	-	4.14
Critical Hdwy Stg 1	5.84	-	-	-	-
Critical Hdwy Stg 2	5.84	-	-	-	-
Follow-up Hdwy	3.52	3.32	-	-	2.22
Pot Cap-1 Maneuver	*157	*609	-	-	888
Stage 1	*574	-	-	-	-
Stage 2	*559	-	-	-	-
Platoon blocked, %	1	1	-	-	1
Mov Cap-1 Maneuver	*147	*609	-	-	888
Mov Cap-2 Maneuver	*316	-	-	-	-
Stage 1	*574	-	-	-	-
Stage 2	*522	-	-	-	-

Approach	WB	NB	SB
HCM Control Delay, s	13.6	0	0.6
HCM LOS	B		

Minor Lane/Major Mvmt	NBT	NBRWBLn1	WBLn2	SBL	SBT
Capacity (veh/h)	-	-	316	609	888
HCM Lane V/C Ratio	-	-	0.11	0.177	0.066
HCM Control Delay (s)	-	-	17.8	12.2	9.3
HCM Lane LOS	-	-	C	B	A
HCM 95th %tile Q(veh)	-	-	0.4	0.6	0.2

Notes
 ~: Volume exceeds capacity \$: Delay exceeds 300s +: Computation Not Defined *: All major volume in platoon

HCM 6th TWSC
3: Eastlake Boulevard & Airport Road

Background Traffic Conditions
AM Peak Hour - Year 2044

Intersection						
Int Delay, s/veh	4.9					
Movement	EBT	EBR	WBL	WBT	NEL	NER
Lane Configurations	↶		↷	↶	↷	↷
Traffic Vol, veh/h	80	3	147	117	11	108
Future Vol, veh/h	80	3	147	117	11	108
Conflicting Peds, #/hr	0	0	0	0	0	0
Sign Control	Free	Free	Free	Free	Stop	Stop
RT Channelized	-	None	-	None	-	None
Storage Length	-	-	400	-	80	-
Veh in Median Storage, #	0	-	-	0	0	-
Grade, %	0	-	-	0	0	-
Peak Hour Factor	92	92	92	92	92	92
Heavy Vehicles, %	2	2	2	2	2	2
Mvmt Flow	87	3	160	127	12	117

Major/Minor	Major1	Major2	Minor1		
Conflicting Flow All	0	0	90	0	536 89
Stage 1	-	-	-	-	89 -
Stage 2	-	-	-	-	447 -
Critical Hdwy	-	-	4.12	-	6.42 6.22
Critical Hdwy Stg 1	-	-	-	-	5.42 -
Critical Hdwy Stg 2	-	-	-	-	5.42 -
Follow-up Hdwy	-	-	2.218	-	3.518 3.318
Pot Cap-1 Maneuver	-	-	1505	-	505 969
Stage 1	-	-	-	-	934 -
Stage 2	-	-	-	-	644 -
Platoon blocked, %	-	-	-	-	-
Mov Cap-1 Maneuver	-	-	1505	-	451 969
Mov Cap-2 Maneuver	-	-	-	-	451 -
Stage 1	-	-	-	-	934 -
Stage 2	-	-	-	-	576 -

Approach	EB	WB	NE
HCM Control Delay, s	0	4.3	9.6
HCM LOS			A

Minor Lane/Major Mvmt	NELn1	NELn2	EBT	EBR	WBL	WBT
Capacity (veh/h)	451	969	-	-	1505	-
HCM Lane V/C Ratio	0.027	0.121	-	-	0.106	-
HCM Control Delay (s)	13.2	9.2	-	-	7.7	-
HCM Lane LOS	B	A	-	-	A	-
HCM 95th %tile Q(veh)	0.1	0.4	-	-	0.4	-

HCM 6th TWSC
4: Eastlake Boulevard & Salt Drive

Background Traffic Conditions
AM Peak Hour - Year 2044

Intersection						
Int Delay, s/veh	0.4					
Movement	NWL	NWR	NET	NER	SWL	SWT
Lane Configurations	↘↙		↔		↖↗	
Traffic Vol, veh/h	6	5	113	0	3	147
Future Vol, veh/h	6	5	113	0	3	147
Conflicting Peds, #/hr	0	0	0	0	0	0
Sign Control	Stop	Stop	Free	Free	Free	Free
RT Channelized	-	None	-	None	-	None
Storage Length	0	-	-	-	-	-
Veh in Median Storage, #	0	-	0	-	-	0
Grade, %	0	-	0	-	-	0
Peak Hour Factor	92	92	92	92	92	92
Heavy Vehicles, %	2	2	2	2	2	2
Mvmt Flow	7	5	123	0	3	160

Major/Minor	Minor1	Major1	Major2			
Conflicting Flow All	289	123	0	0	123	0
Stage 1	123	-	-	-	-	-
Stage 2	166	-	-	-	-	-
Critical Hdwy	6.42	6.22	-	-	4.12	-
Critical Hdwy Stg 1	5.42	-	-	-	-	-
Critical Hdwy Stg 2	5.42	-	-	-	-	-
Follow-up Hdwy	3.518	3.318	-	-	2.218	-
Pot Cap-1 Maneuver	702	928	-	-	1464	-
Stage 1	902	-	-	-	-	-
Stage 2	863	-	-	-	-	-
Platoon blocked, %			-	-		-
Mov Cap-1 Maneuver	701	928	-	-	1464	-
Mov Cap-2 Maneuver	721	-	-	-	-	-
Stage 1	902	-	-	-	-	-
Stage 2	861	-	-	-	-	-

Approach	NW	NE	SW
HCM Control Delay, s	9.6	0	0.1
HCM LOS	A		

Minor Lane/Major Mvmt	NET	NER	NWLn1	SWL	SWT
Capacity (veh/h)	-	-	802	1464	-
HCM Lane V/C Ratio	-	-	0.015	0.002	-
HCM Control Delay (s)	-	-	9.6	7.5	0
HCM Lane LOS	-	-	A	A	A
HCM 95th %tile Q(veh)	-	-	0	0	-

HCM 6th TWSC
5: Eastlake Boulevard & Huron Road

Background Traffic Conditions
AM Peak Hour - Year 2044

Intersection						
Int Delay, s/veh	0.7					
Movement	WBL	WBR	NET	NER	SWL	SWT
Lane Configurations	↔		↔		↔	↔
Traffic Vol, veh/h	11	9	104	8	2	152
Future Vol, veh/h	11	9	104	8	2	152
Conflicting Peds, #/hr	0	0	0	0	0	0
Sign Control	Stop	Stop	Free	Free	Free	Free
RT Channelized	-	None	-	None	-	None
Storage Length	0	-	-	-	200	-
Veh in Median Storage, #	0	-	0	-	-	0
Grade, %	0	-	0	-	-	0
Peak Hour Factor	92	92	92	92	92	92
Heavy Vehicles, %	2	2	2	2	2	2
Mvmt Flow	12	10	113	9	2	165

Major/Minor	Minor1	Major1	Major2			
Conflicting Flow All	287	118	0	0	122	0
Stage 1	118	-	-	-	-	-
Stage 2	169	-	-	-	-	-
Critical Hdwy	6.42	6.22	-	-	4.12	-
Critical Hdwy Stg 1	5.42	-	-	-	-	-
Critical Hdwy Stg 2	5.42	-	-	-	-	-
Follow-up Hdwy	3.518	3.318	-	-	2.218	-
Pot Cap-1 Maneuver	703	934	-	-	1465	-
Stage 1	907	-	-	-	-	-
Stage 2	861	-	-	-	-	-
Platoon blocked, %			-	-	-	-
Mov Cap-1 Maneuver	702	934	-	-	1465	-
Mov Cap-2 Maneuver	702	-	-	-	-	-
Stage 1	907	-	-	-	-	-
Stage 2	860	-	-	-	-	-

Approach	WB	NE	SW
HCM Control Delay, s	9.7	0	0.1
HCM LOS	A		

Minor Lane/Major Mvmt	NET	NERWBLn1	SWL	SWT
Capacity (veh/h)	-	-	790	1465
HCM Lane V/C Ratio	-	-	0.028	0.001
HCM Control Delay (s)	-	-	9.7	7.5
HCM Lane LOS	-	-	A	A
HCM 95th %tile Q(veh)	-	-	0.1	0

HCM 6th TWSC
6: Eastlake Boulevard & Erie Road

Background Traffic Conditions
AM Peak Hour - Year 2044

Intersection						
Int Delay, s/veh	0.5					
Movement	NWL	NWR	NET	NER	SWL	SWT
Lane Configurations	↙↘		↔		↙↘	↕
Traffic Vol, veh/h	8	5	107	5	2	161
Future Vol, veh/h	8	5	107	5	2	161
Conflicting Peds, #/hr	0	0	0	0	0	0
Sign Control	Stop	Stop	Free	Free	Free	Free
RT Channelized	-	None	-	None	-	None
Storage Length	0	-	-	-	180	-
Veh in Median Storage, #	0	-	0	-	-	0
Grade, %	0	-	0	-	-	0
Peak Hour Factor	92	92	92	92	92	92
Heavy Vehicles, %	2	2	2	2	2	2
Mvmt Flow	9	5	116	5	2	175

Major/Minor	Minor1	Major1	Major2		
Conflicting Flow All	298	119	0	0	121
Stage 1	119	-	-	-	-
Stage 2	179	-	-	-	-
Critical Hdwy	6.42	6.22	-	-	4.12
Critical Hdwy Stg 1	5.42	-	-	-	-
Critical Hdwy Stg 2	5.42	-	-	-	-
Follow-up Hdwy	3.518	3.318	-	-	2.218
Pot Cap-1 Maneuver	693	933	-	-	1467
Stage 1	906	-	-	-	-
Stage 2	852	-	-	-	-
Platoon blocked, %			-	-	-
Mov Cap-1 Maneuver	692	933	-	-	1467
Mov Cap-2 Maneuver	715	-	-	-	-
Stage 1	906	-	-	-	-
Stage 2	851	-	-	-	-

Approach	NW	NE	SW
HCM Control Delay, s	9.7	0	0.1
HCM LOS	A		

Minor Lane/Major Mvmt	NET	NER	NWLn1	SWL	SWT
Capacity (veh/h)	-	-	786	1467	-
HCM Lane V/C Ratio	-	-	0.018	0.001	-
HCM Control Delay (s)	-	-	9.7	7.5	-
HCM Lane LOS	-	-	A	A	-
HCM 95th %tile Q(veh)	-	-	0.1	0	-

HCM 6th TWSC
7: Manitoba Drive/Access A & Eastlake Boulevard

Background Traffic Conditions
AM Peak Hour - Year 2044

Intersection												
Int Delay, s/veh	2.4											
Movement	EBL	EBT	EBR	WBL	WBT	WBR	NBL	NBT	NBR	SBL	SBT	SBR
Lane Configurations	↖	↗		↖	↗			↕			↕	
Traffic Vol, veh/h	23	107	35	2	150	17	48	0	2	3	0	17
Future Vol, veh/h	23	107	35	2	150	17	48	0	2	3	0	17
Conflicting Peds, #/hr	0	0	0	0	0	0	0	0	0	0	0	0
Sign Control	Free	Free	Free	Free	Free	Free	Stop	Stop	Stop	Stop	Stop	Stop
RT Channelized	-	-	None	-	-	None	-	-	None	-	-	None
Storage Length	105	-	-	170	-	-	-	-	-	-	-	-
Veh in Median Storage, #	-	0	-	-	0	-	-	0	-	-	0	-
Grade, %	-	0	-	-	0	-	-	0	-	-	0	-
Peak Hour Factor	92	92	92	92	92	92	92	92	92	92	92	92
Heavy Vehicles, %	2	2	2	2	2	2	2	2	2	2	2	2
Mvmt Flow	25	116	38	2	163	18	52	0	2	3	0	18

























Major/Minor	Major1			Major2			Minor1			Minor2		
Conflicting Flow All	181	0	0	154	0	0	370	370	135	362	380	172
Stage 1	-	-	-	-	-	-	185	185	-	176	176	-
Stage 2	-	-	-	-	-	-	185	185	-	186	204	-
Critical Hdwy	4.12	-	-	4.12	-	-	7.12	6.52	6.22	7.12	6.52	6.22
Critical Hdwy Stg 1	-	-	-	-	-	-	6.12	5.52	-	6.12	5.52	-
Critical Hdwy Stg 2	-	-	-	-	-	-	6.12	5.52	-	6.12	5.52	-
Follow-up Hdwy	2.218	-	-	2.218	-	-	3.518	4.018	3.318	3.518	4.018	3.318
Pot Cap-1 Maneuver	1394	-	-	1426	-	-	587	560	914	594	552	872
Stage 1	-	-	-	-	-	-	817	747	-	826	753	-
Stage 2	-	-	-	-	-	-	817	747	-	816	733	-
Platoon blocked, %	-	-	-	-	-	-	-	-	-	-	-	-
Mov Cap-1 Maneuver	1394	-	-	1426	-	-	566	549	914	584	542	872
Mov Cap-2 Maneuver	-	-	-	-	-	-	566	549	-	584	542	-
Stage 1	-	-	-	-	-	-	802	734	-	811	752	-
Stage 2	-	-	-	-	-	-	799	746	-	799	720	-

Approach	EB			WB			NB			SB		
HCM Control Delay, s	1.1			0.1			11.9			9.6		
HCM LOS							B			A		

Minor Lane/Major Mvmt	NBLn1	EBL	EBT	EBR	WBL	WBT	WBR	SBLn1
Capacity (veh/h)	575	1394	-	-	1426	-	-	812
HCM Lane V/C Ratio	0.095	0.018	-	-	0.002	-	-	0.027
HCM Control Delay (s)	11.9	7.6	-	-	7.5	-	-	9.6
HCM Lane LOS	B	A	-	-	A	-	-	A
HCM 95th %tile Q(veh)	0.3	0.1	-	-	0	-	-	0.1

Timings
1: S Union Boulevard & Eastlake Boulevard

Background Traffic Conditions
PM Peak Hour - Year 2044





												
Lane Group	EBL	EBT	EBR	WBL	WBT	WBR	NBL	NBT	NBR	SBL	SBT	SBR
Lane Configurations												
Traffic Volume (vph)	81	114	26	77	84	20	15	884	38	48	1121	80
Future Volume (vph)	81	114	26	77	84	20	15	884	38	48	1121	80
Satd. Flow (prot)	1770	1863	1583	1770	1863	1583	1770	3518	0	1770	3539	1583
Flt Permitted	0.698			0.677			0.203			0.270		
Satd. Flow (perm)	1300	1863	1583	1261	1863	1583	378	3518	0	503	3539	1583
Satd. Flow (RTOR)			45			45		14				55
Lane Group Flow (vph)	88	124	28	84	91	22	16	1002	0	52	1218	87
Turn Type	Perm	NA	Perm	Perm	NA	Perm	Perm	NA		Perm	NA	Perm
Protected Phases		4			8			2			6	
Permitted Phases	4		4	8		8	2			6		6
Detector Phase	4	4	4	8	8	8	2	2		6	6	6
Switch Phase												
Minimum Initial (s)	4.0	4.0	4.0	4.0	4.0	4.0	4.0	4.0		4.0	4.0	4.0
Minimum Split (s)	10.0	10.0	10.0	10.0	10.0	10.0	9.5	9.5		9.5	9.5	9.5
Total Split (s)	16.0	16.0	16.0	16.0	16.0	16.0	44.0	44.0		44.0	44.0	44.0
Total Split (%)	26.7%	26.7%	26.7%	26.7%	26.7%	26.7%	73.3%	73.3%		73.3%	73.3%	73.3%
Yellow Time (s)	4.0	4.0	4.0	4.0	4.0	4.0	3.5	3.5		3.5	3.5	3.5
All-Red Time (s)	2.0	2.0	2.0	2.0	2.0	2.0	2.0	2.0		2.0	2.0	2.0
Lost Time Adjust (s)	0.0	0.0	0.0	0.0	0.0	0.0	0.0	0.0		0.0	0.0	0.0
Total Lost Time (s)	6.0	6.0	6.0	6.0	6.0	6.0	5.5	5.5		5.5	5.5	5.5
Lead/Lag												
Lead-Lag Optimize?												
Recall Mode	None	None	None	None	None	None	C-Max	C-Max		C-Max	C-Max	C-Max
Act Effct Green (s)	8.6	8.6	8.6	8.5	8.5	8.5	43.4	43.4		43.4	43.4	43.4
Actuated g/C Ratio	0.14	0.14	0.14	0.14	0.14	0.14	0.72	0.72		0.72	0.72	0.72
v/c Ratio	0.47	0.46	0.11	0.47	0.34	0.08	0.06	0.39		0.14	0.48	0.08
Control Delay	32.0	29.1	6.1	32.1	26.3	4.4	4.7	5.0		5.4	5.7	2.2
Queue Delay	0.0	0.0	0.0	0.0	0.0	0.0	0.0	0.0		0.0	0.0	0.0
Total Delay	32.0	29.1	6.1	32.1	26.3	4.4	4.7	5.0		5.4	5.7	2.2
LOS	C	C	A	C	C	A	A	A		A	A	A
Approach Delay		27.5			26.3			5.0			5.5	
Approach LOS		C			C			A			A	
Queue Length 50th (ft)	29	41	0	28	30	0	2	74		6	101	3
Queue Length 95th (ft)	67	84	13	65	65	9	8	110		19	147	15
Internal Link Dist (ft)		416			208			351			547	
Turn Bay Length (ft)	65		60	40		40	100			125		30
Base Capacity (vph)	216	310	301	210	310	301	273	2546		363	2557	1159
Starvation Cap Reductn	0	0	0	0	0	0	0	0		0	0	0
Spillback Cap Reductn	0	0	0	0	0	0	0	0		0	0	0
Storage Cap Reductn	0	0	0	0	0	0	0	0		0	0	0
Reduced v/c Ratio	0.41	0.40	0.09	0.40	0.29	0.07	0.06	0.39		0.14	0.48	0.08
Intersection Summary												
Cycle Length: 60												
Actuated Cycle Length: 60												
Offset: 0 (0%), Referenced to phase 2:NBTL and 6:SBTL, Start of Green												
Natural Cycle: 40												
Control Type: Actuated-Coordinated												

Timings
 1: S Union Boulevard & Eastlake Boulevard

Background Traffic Conditions
 PM Peak Hour - Year 2044

Maximum v/c Ratio: 0.48	
Intersection Signal Delay: 8.6	Intersection LOS: A
Intersection Capacity Utilization 59.6%	ICU Level of Service B
Analysis Period (min) 15	

Splits and Phases: 1: S Union Boulevard & Eastlake Boulevard

 Ø2 (R) 44 s	 Ø4 16 s
 Ø6 (R) 44 s	 Ø8 16 s

HCM 6th TWSC
2: S Union Boulevard & Airport Road

Background Traffic Conditions
PM Peak Hour - Year 2044

Intersection						
Int Delay, s/veh	1.1					
Movement	WBL	WBR	NBT	NBR	SBL	SBT
Lane Configurations	↘	↗	↑↑	↗	↘	↑↑
Traffic Vol, veh/h	39	71	954	36	102	1187
Future Vol, veh/h	39	71	954	36	102	1187
Conflicting Peds, #/hr	0	0	0	0	0	0
Sign Control	Stop	Stop	Free	Free	Free	Free
RT Channelized	-	None	-	None	-	None
Storage Length	0	70	-	60	350	-
Veh in Median Storage, #	0	-	0	-	-	0
Grade, %	0	-	0	-	-	0
Peak Hour Factor	92	92	92	92	92	92
Heavy Vehicles, %	2	2	2	2	2	2
Mvmt Flow	42	77	1037	39	111	1290

Major/Minor	Minor1	Major1	Major2		
Conflicting Flow All	1904	519	0	0	1076
Stage 1	1037	-	-	-	-
Stage 2	867	-	-	-	-
Critical Hdwy	6.84	6.94	-	-	4.14
Critical Hdwy Stg 1	5.84	-	-	-	-
Critical Hdwy Stg 2	5.84	-	-	-	-
Follow-up Hdwy	3.52	3.32	-	-	2.22
Pot Cap-1 Maneuver	96	*711	-	-	1004
Stage 1	664	-	-	-	-
Stage 2	372	-	-	-	-
Platoon blocked, %	1	1	-	-	1
Mov Cap-1 Maneuver	85	*711	-	-	1004
Mov Cap-2 Maneuver	235	-	-	-	-
Stage 1	664	-	-	-	-
Stage 2	331	-	-	-	-

Approach	WB	NB	SB
HCM Control Delay, s	15.3	0	0.7
HCM LOS	C		

Minor Lane/Major Mvmt	NBT	NBRWBLn1	WBLn2	SBL	SBT
Capacity (veh/h)	-	-	235	711	1004
HCM Lane V/C Ratio	-	-	0.18	0.109	0.11
HCM Control Delay (s)	-	-	23.7	10.7	9
HCM Lane LOS	-	-	C	B	A
HCM 95th %tile Q(veh)	-	-	0.6	0.4	0.4

Notes
 ~: Volume exceeds capacity \$: Delay exceeds 300s +: Computation Not Defined *: All major volume in platoon

HCM 6th TWSC
 3: Eastlake Boulevard & Airport Road

Background Traffic Conditions
 PM Peak Hour - Year 2044

Intersection						
Int Delay, s/veh	5					
Movement	EBT	EBR	WBL	WBT	NEL	NER
Lane Configurations	↶		↷	↶	↷	↷
Traffic Vol, veh/h	128	17	147	110	6	159
Future Vol, veh/h	128	17	147	110	6	159
Conflicting Peds, #/hr	0	0	0	0	0	0
Sign Control	Free	Free	Free	Free	Stop	Stop
RT Channelized	-	None	-	None	-	None
Storage Length	-	-	400	-	80	-
Veh in Median Storage, #	0	-	-	0	0	-
Grade, %	0	-	-	0	0	-
Peak Hour Factor	92	92	92	92	92	92
Heavy Vehicles, %	2	2	2	2	2	2
Mvmt Flow	139	18	160	120	7	173

Major/Minor	Major1	Major2	Minor1		
Conflicting Flow All	0	0	157	0	588 148
Stage 1	-	-	-	-	148 -
Stage 2	-	-	-	-	440 -
Critical Hdwy	-	-	4.12	-	6.42 6.22
Critical Hdwy Stg 1	-	-	-	-	5.42 -
Critical Hdwy Stg 2	-	-	-	-	5.42 -
Follow-up Hdwy	-	-	2.218	-	3.518 3.318
Pot Cap-1 Maneuver	-	-	1423	-	471 899
Stage 1	-	-	-	-	880 -
Stage 2	-	-	-	-	649 -
Platoon blocked, %	-	-	-	-	-
Mov Cap-1 Maneuver	-	-	1423	-	418 899
Mov Cap-2 Maneuver	-	-	-	-	418 -
Stage 1	-	-	-	-	880 -
Stage 2	-	-	-	-	576 -

Approach	EB	WB	NE
HCM Control Delay, s	0	4.5	10.1
HCM LOS			B

Minor Lane/Major Mvmt	NELn1	NELn2	EBT	EBR	WBL	WBT
Capacity (veh/h)	418	899	-	-	1423	-
HCM Lane V/C Ratio	0.016	0.192	-	-	0.112	-
HCM Control Delay (s)	13.7	10	-	-	7.8	-
HCM Lane LOS	B	B	-	-	A	-
HCM 95th %tile Q(veh)	0	0.7	-	-	0.4	-

HCM 6th TWSC
4: Eastlake Boulevard & Salt Drive

Background Traffic Conditions
PM Peak Hour - Year 2044

Intersection						
Int Delay, s/veh	0.4					
Movement	NWL	NWR	NET	NER	SWL	SWT
Lane Configurations						
Traffic Vol, veh/h	6	5	156	5	3	161
Future Vol, veh/h	6	5	156	5	3	161
Conflicting Peds, #/hr	0	0	0	0	0	0
Sign Control	Stop	Stop	Free	Free	Free	Free
RT Channelized	-	None	-	None	-	None
Storage Length	0	-	-	-	-	-
Veh in Median Storage, #	0	-	0	-	-	0
Grade, %	0	-	0	-	-	0
Peak Hour Factor	92	92	92	92	92	92
Heavy Vehicles, %	2	2	2	2	2	2
Mvmt Flow	7	5	170	5	3	175

Major/Minor	Minor1	Major1	Major2			
Conflicting Flow All	354	173	0	0	175	0
Stage 1	173	-	-	-	-	-
Stage 2	181	-	-	-	-	-
Critical Hdwy	6.42	6.22	-	-	4.12	-
Critical Hdwy Stg 1	5.42	-	-	-	-	-
Critical Hdwy Stg 2	5.42	-	-	-	-	-
Follow-up Hdwy	3.518	3.318	-	-	2.218	-
Pot Cap-1 Maneuver	644	871	-	-	1401	-
Stage 1	857	-	-	-	-	-
Stage 2	850	-	-	-	-	-
Platoon blocked, %			-	-	-	-
Mov Cap-1 Maneuver	643	871	-	-	1401	-
Mov Cap-2 Maneuver	682	-	-	-	-	-
Stage 1	857	-	-	-	-	-
Stage 2	848	-	-	-	-	-

Approach	NW	NE	SW
HCM Control Delay, s	9.8	0	0.1
HCM LOS	A		

Minor Lane/Major Mvmt	NET	NER	NWLn1	SWL	SWT
Capacity (veh/h)	-	-	757	1401	-
HCM Lane V/C Ratio	-	-	0.016	0.002	-
HCM Control Delay (s)	-	-	9.8	7.6	0
HCM Lane LOS	-	-	A	A	A
HCM 95th %tile Q(veh)	-	-	0	0	-

HCM 6th TWSC
5: Eastlake Boulevard & Huron Road

Background Traffic Conditions
PM Peak Hour - Year 2044

Intersection						
Int Delay, s/veh	0.5					
Movement	WBL	WBR	NET	NER	SWL	SWT
Lane Configurations	↙↘		↖↗		↙	↗
Traffic Vol, veh/h	6	2	159	14	11	156
Future Vol, veh/h	6	2	159	14	11	156
Conflicting Peds, #/hr	0	0	0	0	0	0
Sign Control	Stop	Stop	Free	Free	Free	Free
RT Channelized	-	None	-	None	-	None
Storage Length	0	-	-	-	200	-
Veh in Median Storage, #	0	-	0	-	-	0
Grade, %	0	-	0	-	-	0
Peak Hour Factor	92	92	92	92	92	92
Heavy Vehicles, %	2	2	2	2	2	2
Mvmt Flow	7	2	173	15	12	170

Major/Minor	Minor1	Major1	Major2			
Conflicting Flow All	375	181	0	0	188	0
Stage 1	181	-	-	-	-	-
Stage 2	194	-	-	-	-	-
Critical Hdwy	6.42	6.22	-	-	4.12	-
Critical Hdwy Stg 1	5.42	-	-	-	-	-
Critical Hdwy Stg 2	5.42	-	-	-	-	-
Follow-up Hdwy	3.518	3.318	-	-	2.218	-
Pot Cap-1 Maneuver	626	862	-	-	1386	-
Stage 1	850	-	-	-	-	-
Stage 2	839	-	-	-	-	-
Platoon blocked, %			-	-	-	-
Mov Cap-1 Maneuver	620	862	-	-	1386	-
Mov Cap-2 Maneuver	620	-	-	-	-	-
Stage 1	850	-	-	-	-	-
Stage 2	831	-	-	-	-	-

Approach	WB	NE	SW
HCM Control Delay, s	10.5	0	0.5
HCM LOS	B		

Minor Lane/Major Mvmt	NET	NERWBLn1	SWL	SWT
Capacity (veh/h)	-	-	667	1386
HCM Lane V/C Ratio	-	-	0.013	0.009
HCM Control Delay (s)	-	-	10.5	7.6
HCM Lane LOS	-	-	B	A
HCM 95th %tile Q(veh)	-	-	0	0

HCM 6th TWSC
6: Eastlake Boulevard & Erie Road

Background Traffic Conditions
PM Peak Hour - Year 2044

Intersection						
Int Delay, s/veh	0.3					
Movement	NWL	NWR	NET	NER	SWL	SWT
Lane Configurations	↙↘		↕		↙↘	↕
Traffic Vol, veh/h	6	3	170	11	3	159
Future Vol, veh/h	6	3	170	11	3	159
Conflicting Peds, #/hr	0	0	0	0	0	0
Sign Control	Stop	Stop	Free	Free	Free	Free
RT Channelized	-	None	-	None	-	None
Storage Length	0	-	-	-	180	-
Veh in Median Storage, #	0	-	0	-	-	0
Grade, %	0	-	0	-	-	0
Peak Hour Factor	92	92	92	92	92	92
Heavy Vehicles, %	2	2	2	2	2	2
Mvmt Flow	7	3	185	12	3	173

Major/Minor	Minor1	Major1	Major2		
Conflicting Flow All	370	191	0	0	197
Stage 1	191	-	-	-	-
Stage 2	179	-	-	-	-
Critical Hdwy	6.42	6.22	-	-	4.12
Critical Hdwy Stg 1	5.42	-	-	-	-
Critical Hdwy Stg 2	5.42	-	-	-	-
Follow-up Hdwy	3.518	3.318	-	-	2.218
Pot Cap-1 Maneuver	630	851	-	-	1376
Stage 1	841	-	-	-	-
Stage 2	852	-	-	-	-
Platoon blocked, %			-	-	-
Mov Cap-1 Maneuver	629	851	-	-	1376
Mov Cap-2 Maneuver	673	-	-	-	-
Stage 1	841	-	-	-	-
Stage 2	850	-	-	-	-

Approach	NW	NE	SW
HCM Control Delay, s	10	0	0.1
HCM LOS	B		

Minor Lane/Major Mvmt	NET	NER	NWLn1	SWL	SWT
Capacity (veh/h)	-	-	723	1376	-
HCM Lane V/C Ratio	-	-	0.014	0.002	-
HCM Control Delay (s)	-	-	10	7.6	-
HCM Lane LOS	-	-	B	A	-
HCM 95th %tile Q(veh)	-	-	0	0	-

HCM 6th TWSC
7: Manitoba Drive/Access A & Eastlake Boulevard

Background Traffic Conditions
PM Peak Hour - Year 2044

Intersection												
Int Delay, s/veh	1.2											
Movement	EBL	EBT	EBR	WBL	WBT	WBR	NBL	NBT	NBR	SBL	SBT	SBR
Lane Configurations	↖	↗		↖	↗			↕			↕	
Traffic Vol, veh/h	2	167	32	3	158	5	15	0	3	11	0	14
Future Vol, veh/h	2	167	32	3	158	5	15	0	3	11	0	14
Conflicting Peds, #/hr	0	0	0	0	0	0	0	0	0	0	0	0
Sign Control	Free	Free	Free	Free	Free	Free	Stop	Stop	Stop	Stop	Stop	Stop
RT Channelized	-	-	None	-	-	None	-	-	None	-	-	None
Storage Length	105	-	-	170	-	-	-	-	-	-	-	-
Veh in Median Storage, #	-	0	-	-	0	-	-	0	-	-	0	-
Grade, %	-	0	-	-	0	-	-	0	-	-	0	-
Peak Hour Factor	92	92	92	92	92	92	92	92	92	92	92	92
Heavy Vehicles, %	2	2	2	2	2	2	2	2	2	2	2	2
Mvmt Flow	2	182	35	3	172	5	16	0	3	12	0	15

























Major/Minor	Major1			Major2			Minor1			Minor2		
Conflicting Flow All	177	0	0	217	0	0	392	387	200	386	402	175
Stage 1	-	-	-	-	-	-	204	204	-	181	181	-
Stage 2	-	-	-	-	-	-	188	183	-	205	221	-
Critical Hdwy	4.12	-	-	4.12	-	-	7.12	6.52	6.22	7.12	6.52	6.22
Critical Hdwy Stg 1	-	-	-	-	-	-	6.12	5.52	-	6.12	5.52	-
Critical Hdwy Stg 2	-	-	-	-	-	-	6.12	5.52	-	6.12	5.52	-
Follow-up Hdwy	2.218	-	-	2.218	-	-	3.518	4.018	3.318	3.518	4.018	3.318
Pot Cap-1 Maneuver	1399	-	-	1353	-	-	567	547	841	573	537	868
Stage 1	-	-	-	-	-	-	798	733	-	821	750	-
Stage 2	-	-	-	-	-	-	814	748	-	797	720	-
Platoon blocked, %	-	-	-	-	-	-	-	-	-	-	-	-
Mov Cap-1 Maneuver	1399	-	-	1353	-	-	556	545	841	569	535	868
Mov Cap-2 Maneuver	-	-	-	-	-	-	556	545	-	569	535	-
Stage 1	-	-	-	-	-	-	797	732	-	820	749	-
Stage 2	-	-	-	-	-	-	798	747	-	793	719	-

Approach	EB			WB			NB			SB		
HCM Control Delay, s	0.1			0.1			11.3			10.3		
HCM LOS							B			B		

Minor Lane/Major Mvmt	NBLn1	EBL	EBT	EBR	WBL	WBT	WBR	SBLn1
Capacity (veh/h)	589	1399	-	-	1353	-	-	705
HCM Lane V/C Ratio	0.033	0.002	-	-	0.002	-	-	0.039
HCM Control Delay (s)	11.3	7.6	-	-	7.7	-	-	10.3
HCM Lane LOS	B	A	-	-	A	-	-	B
HCM 95th %tile Q(veh)	0.1	0	-	-	0	-	-	0.1

Timings
1: S Union Boulevard & Eastlake Boulevard

Total Traffic Conditions
AM Peak Hour - Year 2026

												
Lane Group	EBL	EBT	EBR	WBL	WBT	WBR	NBL	NBT	NBR	SBL	SBT	SBR
Lane Configurations												
Traffic Volume (vph)	39	63	21	60	64	28	11	786	37	14	463	32
Future Volume (vph)	39	63	21	60	64	28	11	786	37	14	463	32
Satd. Flow (prot)	1770	1863	1583	1770	1863	1583	1770	3514	0	1770	3539	1583
Flt Permitted	0.711			0.713			0.467			0.309		
Satd. Flow (perm)	1324	1863	1583	1328	1863	1583	870	3514	0	576	3539	1583
Satd. Flow (RTOR)			45			45		11				55
Lane Group Flow (vph)	42	68	23	65	70	30	12	894	0	15	503	35
Turn Type	Perm	NA	Perm	Perm	NA	Perm	Perm	NA		Perm	NA	Perm
Protected Phases		4			8			2				6
Permitted Phases	4		4	8		8	2			6		6
Detector Phase	4	4	4	8	8	8	2	2		6	6	6
Switch Phase												
Minimum Initial (s)	4.0	4.0	4.0	4.0	4.0	4.0	4.0	4.0		4.0	4.0	4.0
Minimum Split (s)	10.0	10.0	10.0	10.0	10.0	10.0	9.5	9.5		9.5	9.5	9.5
Total Split (s)	25.0	25.0	25.0	25.0	25.0	25.0	35.0	35.0		35.0	35.0	35.0
Total Split (%)	41.7%	41.7%	41.7%	41.7%	41.7%	41.7%	58.3%	58.3%		58.3%	58.3%	58.3%
Yellow Time (s)	4.0	4.0	4.0	4.0	4.0	4.0	3.5	3.5		3.5	3.5	3.5
All-Red Time (s)	2.0	2.0	2.0	2.0	2.0	2.0	2.0	2.0		2.0	2.0	2.0
Lost Time Adjust (s)	0.0	0.0	0.0	0.0	0.0	0.0	0.0	0.0		0.0	0.0	0.0
Total Lost Time (s)	6.0	6.0	6.0	6.0	6.0	6.0	5.5	5.5		5.5	5.5	5.5
Lead/Lag												
Lead-Lag Optimize?												
Recall Mode	None	None	None	None	None	None	C-Max	C-Max		C-Max	C-Max	C-Max
Act Effct Green (s)	8.4	8.4	8.4	8.4	8.4	8.4	43.5	43.5		43.5	43.5	43.5
Actuated g/C Ratio	0.14	0.14	0.14	0.14	0.14	0.14	0.72	0.72		0.72	0.72	0.72
v/c Ratio	0.23	0.26	0.09	0.35	0.27	0.12	0.02	0.35		0.04	0.20	0.03
Control Delay	24.7	24.5	4.3	27.7	24.6	6.2	4.4	4.8		4.6	4.1	1.0
Queue Delay	0.0	0.0	0.0	0.0	0.0	0.0	0.0	0.0		0.0	0.0	0.0
Total Delay	24.7	24.5	4.3	27.7	24.6	6.2	4.4	4.8		4.6	4.1	1.0
LOS	C	C	A	C	C	A	A	A		A	A	A
Approach Delay		21.1			22.5			4.8				4.0
Approach LOS		C			C			A				A
Queue Length 50th (ft)	14	22	0	22	23	0	1	59		1	29	0
Queue Length 95th (ft)	36	50	9	50	51	14	6	106		8	56	5
Internal Link Dist (ft)		416			208			351				224
Turn Bay Length (ft)	65		60	40		40	100			125		30
Base Capacity (vph)	419	589	532	420	589	532	630	2549		417	2564	1162
Starvation Cap Reductn	0	0	0	0	0	0	0	0		0	0	0
Spillback Cap Reductn	0	0	0	0	0	0	0	0		0	0	0
Storage Cap Reductn	0	0	0	0	0	0	0	0		0	0	0
Reduced v/c Ratio	0.10	0.12	0.04	0.15	0.12	0.06	0.02	0.35		0.04	0.20	0.03
Intersection Summary												
Cycle Length: 60												
Actuated Cycle Length: 60												
Offset: 0 (0%), Referenced to phase 2:NBTL and 6:SBTL, Start of Green												
Natural Cycle: 40												
Control Type: Actuated-Coordinated												

Timings
 1: S Union Boulevard & Eastlake Boulevard

Total Traffic Conditions
 AM Peak Hour - Year 2026

Maximum v/c Ratio: 0.35	
Intersection Signal Delay: 7.4	Intersection LOS: A
Intersection Capacity Utilization 44.2%	ICU Level of Service A
Analysis Period (min) 15	

Splits and Phases: 1: S Union Boulevard & Eastlake Boulevard

 Ø2 (R) 35 s	 Ø4 25 s
 Ø6 (R) 35 s	 Ø8 25 s

HCM 6th TWSC
2: S Union Boulevard & Airport Road

Total Traffic Conditions
AM Peak Hour - Year 2026

Intersection						
Int Delay, s/veh	0.9					
Movement	WBL	WBR	NBT	NBR	SBL	SBT
Lane Configurations	↘	↗	↑↑	↗	↘	↑↑
Traffic Vol, veh/h	22	74	829	24	39	519
Future Vol, veh/h	22	74	829	24	39	519
Conflicting Peds, #/hr	0	0	0	0	0	0
Sign Control	Stop	Stop	Free	Free	Free	Free
RT Channelized	-	None	-	None	-	None
Storage Length	0	70	-	60	350	-
Veh in Median Storage, #	0	-	0	-	-	0
Grade, %	0	-	0	-	-	0
Peak Hour Factor	92	92	92	92	92	92
Heavy Vehicles, %	2	2	2	2	2	2
Mvmt Flow	24	80	901	26	42	564

Major/Minor	Minor1	Major1	Major2		
Conflicting Flow All	1267	451	0	0	927
Stage 1	901	-	-	-	-
Stage 2	366	-	-	-	-
Critical Hdwy	6.84	6.94	-	-	4.14
Critical Hdwy Stg 1	5.84	-	-	-	-
Critical Hdwy Stg 2	5.84	-	-	-	-
Follow-up Hdwy	3.52	3.32	-	-	2.22
Pot Cap-1 Maneuver	333	*762	-	-	1090
Stage 1	705	-	-	-	-
Stage 2	672	-	-	-	-
Platoon blocked, %	1	1	-	-	1
Mov Cap-1 Maneuver	320	*762	-	-	1090
Mov Cap-2 Maneuver	453	-	-	-	-
Stage 1	705	-	-	-	-
Stage 2	646	-	-	-	-

Approach	WB	NB	SB
HCM Control Delay, s	11	0	0.6
HCM LOS	B		

Minor Lane/Major Mvmt	NBT	NBR	WBLn1	WBLn2	SBL	SBT
Capacity (veh/h)	-	-	453	762	1090	-
HCM Lane V/C Ratio	-	-	0.053	0.106	0.039	-
HCM Control Delay (s)	-	-	13.4	10.3	8.4	-
HCM Lane LOS	-	-	B	B	A	-
HCM 95th %tile Q(veh)	-	-	0.2	0.4	0.1	-

Notes
~: Volume exceeds capacity \$: Delay exceeds 300s +: Computation Not Defined *: All major volume in platoon

HCM 6th TWSC
3: Eastlake Boulevard & Airport Road

Total Traffic Conditions
AM Peak Hour - Year 2026

Intersection

Int Delay, s/veh 4.7

Movement	EBT	EBR	WBL	WBT	NEL	NER
Lane Configurations	↔		↔	↑	↔	↔
Traffic Vol, veh/h	57	2	102	82	7	75
Future Vol, veh/h	57	2	102	82	7	75
Conflicting Peds, #/hr	0	0	0	0	0	0
Sign Control	Free	Free	Free	Free	Stop	Stop
RT Channelized	-	None	-	None	-	None
Storage Length	-	-	400	-	80	-
Veh in Median Storage, #	0	-	-	0	0	-
Grade, %	0	-	-	0	0	-
Peak Hour Factor	92	92	92	92	92	92
Heavy Vehicles, %	2	2	2	2	2	2
Mvmt Flow	62	2	111	89	8	82

Major/Minor	Major1	Major2	Minor1
Conflicting Flow All	0	0	64
Stage 1	-	-	-
Stage 2	-	-	-
Critical Hdwy	-	-	4.12
Critical Hdwy Stg 1	-	-	-
Critical Hdwy Stg 2	-	-	-
Follow-up Hdwy	-	-	2.218
Pot Cap-1 Maneuver	-	-	1538
Stage 1	-	-	-
Stage 2	-	-	-
Platoon blocked, %	-	-	-
Mov Cap-1 Maneuver	-	-	1538
Mov Cap-2 Maneuver	-	-	-
Stage 1	-	-	-
Stage 2	-	-	-

Approach	EB	WB	NE
HCM Control Delay, s	0	4.2	9.1
HCM LOS			A

Minor Lane/Major Mvmt	NELn1	NELn2	EBT	EBR	WBL	WBT
Capacity (veh/h)	608	1002	-	-	1538	-
HCM Lane V/C Ratio	0.013	0.081	-	-	0.072	-
HCM Control Delay (s)	11	8.9	-	-	7.5	-
HCM Lane LOS	B	A	-	-	A	-
HCM 95th %tile Q(veh)	0	0.3	-	-	0.2	-

HCM 6th TWSC
4: Eastlake Boulevard & Salt Drive

Total Traffic Conditions
AM Peak Hour - Year 2026

Intersection						
Int Delay, s/veh	0.4					
Movement	NWL	NWR	NET	NER	SWL	SWT
Lane Configurations	T		T		T	
Traffic Vol, veh/h	4	3	78	0	2	102
Future Vol, veh/h	4	3	78	0	2	102
Conflicting Peds, #/hr	0	0	0	0	0	0
Sign Control	Stop	Stop	Free	Free	Free	Free
RT Channelized	-	None	-	None	-	None
Storage Length	0	-	-	-	-	-
Veh in Median Storage, #	0	-	0	-	-	0
Grade, %	0	-	0	-	-	0
Peak Hour Factor	92	92	92	92	92	92
Heavy Vehicles, %	2	2	2	2	2	2
Mvmt Flow	4	3	85	0	2	111

Major/Minor	Minor1	Major1	Major2			
Conflicting Flow All	200	85	0	0	85	0
Stage 1	85	-	-	-	-	-
Stage 2	115	-	-	-	-	-
Critical Hdwy	6.42	6.22	-	-	4.12	-
Critical Hdwy Stg 1	5.42	-	-	-	-	-
Critical Hdwy Stg 2	5.42	-	-	-	-	-
Follow-up Hdwy	3.518	3.318	-	-	2.218	-
Pot Cap-1 Maneuver	789	974	-	-	1512	-
Stage 1	938	-	-	-	-	-
Stage 2	910	-	-	-	-	-
Platoon blocked, %			-	-		-
Mov Cap-1 Maneuver	788	974	-	-	1512	-
Mov Cap-2 Maneuver	780	-	-	-	-	-
Stage 1	938	-	-	-	-	-
Stage 2	909	-	-	-	-	-

Approach	NW	NE	SW
HCM Control Delay, s	9.3	0	0.1
HCM LOS	A		

Minor Lane/Major Mvmt	NET	NER	NWLn1	SWL	SWT
Capacity (veh/h)	-	-	853	1512	-
HCM Lane V/C Ratio	-	-	0.009	0.001	-
HCM Control Delay (s)	-	-	9.3	7.4	0
HCM Lane LOS	-	-	A	A	A
HCM 95th %tile Q(veh)	-	-	0	0	-

HCM 6th TWSC
5: Eastlake Boulevard & Huron Road

Total Traffic Conditions
AM Peak Hour - Year 2026

Intersection						
Int Delay, s/veh	0.7					
Movement	WBL	WBR	NET	NER	SWL	SWT
Lane Configurations	↘↗		↖↗		↘↗	↖↗
Traffic Vol, veh/h	7	6	72	5	1	105
Future Vol, veh/h	7	6	72	5	1	105
Conflicting Peds, #/hr	0	0	0	0	0	0
Sign Control	Stop	Stop	Free	Free	Free	Free
RT Channelized	-	None	-	None	-	None
Storage Length	0	-	-	-	200	-
Veh in Median Storage, #	0	-	0	-	-	0
Grade, %	0	-	0	-	-	0
Peak Hour Factor	92	92	92	92	92	92
Heavy Vehicles, %	2	2	2	2	2	2
Mvmt Flow	8	7	78	5	1	114

Major/Minor	Minor1	Major1	Major2			
Conflicting Flow All	197	81	0	0	83	0
Stage 1	81	-	-	-	-	-
Stage 2	116	-	-	-	-	-
Critical Hdwy	6.42	6.22	-	-	4.12	-
Critical Hdwy Stg 1	5.42	-	-	-	-	-
Critical Hdwy Stg 2	5.42	-	-	-	-	-
Follow-up Hdwy	3.518	3.318	-	-	2.218	-
Pot Cap-1 Maneuver	792	979	-	-	1514	-
Stage 1	942	-	-	-	-	-
Stage 2	909	-	-	-	-	-
Platoon blocked, %			-	-		-
Mov Cap-1 Maneuver	791	979	-	-	1514	-
Mov Cap-2 Maneuver	791	-	-	-	-	-
Stage 1	942	-	-	-	-	-
Stage 2	908	-	-	-	-	-

Approach	WB	NE	SW
HCM Control Delay, s	9.2	0	0.1
HCM LOS	A		

Minor Lane/Major Mvmt	NET	NERWBLn1	SWL	SWT
Capacity (veh/h)	-	-	868	1514
HCM Lane V/C Ratio	-	-	0.016	0.001
HCM Control Delay (s)	-	-	9.2	7.4
HCM Lane LOS	-	-	A	A
HCM 95th %tile Q(veh)	-	-	0.1	0

HCM 6th TWSC
6: Eastlake Boulevard & Erie Road

Total Traffic Conditions
AM Peak Hour - Year 2026

Intersection						
Int Delay, s/veh	0.4					
Movement	NWL	NWR	NET	NER	SWL	SWT
Lane Configurations	↙↘		↔		↙	↘
Traffic Vol, veh/h	5	3	74	3	1	111
Future Vol, veh/h	5	3	74	3	1	111
Conflicting Peds, #/hr	0	0	0	0	0	0
Sign Control	Stop	Stop	Free	Free	Free	Free
RT Channelized	-	None	-	None	-	None
Storage Length	0	-	-	-	180	-
Veh in Median Storage, #	0	-	0	-	-	0
Grade, %	0	-	0	-	-	0
Peak Hour Factor	92	92	92	92	92	92
Heavy Vehicles, %	2	2	2	2	2	2
Mvmt Flow	5	3	80	3	1	121

Major/Minor	Minor1	Major1	Major2		
Conflicting Flow All	205	82	0	0	83
Stage 1	82	-	-	-	-
Stage 2	123	-	-	-	-
Critical Hdwy	6.42	6.22	-	-	4.12
Critical Hdwy Stg 1	5.42	-	-	-	-
Critical Hdwy Stg 2	5.42	-	-	-	-
Follow-up Hdwy	3.518	3.318	-	-	2.218
Pot Cap-1 Maneuver	783	978	-	-	1514
Stage 1	941	-	-	-	-
Stage 2	902	-	-	-	-
Platoon blocked, %			-	-	-
Mov Cap-1 Maneuver	782	978	-	-	1514
Mov Cap-2 Maneuver	776	-	-	-	-
Stage 1	941	-	-	-	-
Stage 2	901	-	-	-	-

Approach	NW	NE	SW
HCM Control Delay, s	9.3	0	0.1
HCM LOS	A		

Minor Lane/Major Mvmt	NET	NERNWLn1	SWL	SWT
Capacity (veh/h)	-	-	841	1514
HCM Lane V/C Ratio	-	-	0.01	0.001
HCM Control Delay (s)	-	-	9.3	7.4
HCM Lane LOS	-	-	A	A
HCM 95th %tile Q(veh)	-	-	0	0

HCM 6th TWSC
7: Manitoba Drive/Access A & Eastlake Boulevard

Total Traffic Conditions
AM Peak Hour - Year 2026

Intersection												
Int Delay, s/veh	2.4											
Movement	EBL	EBT	EBR	WBL	WBT	WBR	NBL	NBT	NBR	SBL	SBT	SBR
Lane Configurations	↖	↗		↖	↗			↕			↕	
Traffic Vol, veh/h	17	74	24	1	104	11	33	0	1	2	0	17
Future Vol, veh/h	17	74	24	1	104	11	33	0	1	2	0	17
Conflicting Peds, #/hr	0	0	0	0	0	0	0	0	0	0	0	0
Sign Control	Free	Free	Free	Free	Free	Free	Stop	Stop	Stop	Stop	Stop	Stop
RT Channelized	-	-	None	-	-	None	-	-	None	-	-	None
Storage Length	105	-	-	170	-	-	-	-	-	-	-	-
Veh in Median Storage, #	-	0	-	-	0	-	-	0	-	-	0	-
Grade, %	-	0	-	-	0	-	-	0	-	-	0	-
Peak Hour Factor	92	92	92	92	92	92	92	92	92	92	92	92
Heavy Vehicles, %	2	2	2	2	2	2	2	2	2	2	2	2
Mvmt Flow	18	80	26	1	113	12	36	0	1	2	0	18

Major/Minor	Major1			Major2			Minor1			Minor2		
Conflicting Flow All	125	0	0	106	0	0	259	256	93	251	263	119
Stage 1	-	-	-	-	-	-	129	129	-	121	121	-
Stage 2	-	-	-	-	-	-	130	127	-	130	142	-
Critical Hdwy	4.12	-	-	4.12	-	-	7.12	6.52	6.22	7.12	6.52	6.22
Critical Hdwy Stg 1	-	-	-	-	-	-	6.12	5.52	-	6.12	5.52	-
Critical Hdwy Stg 2	-	-	-	-	-	-	6.12	5.52	-	6.12	5.52	-
Follow-up Hdwy	2.218	-	-	2.218	-	-	3.518	4.018	3.318	3.518	4.018	3.318
Pot Cap-1 Maneuver	1462	-	-	1485	-	-	694	648	964	702	642	933
Stage 1	-	-	-	-	-	-	875	789	-	883	796	-
Stage 2	-	-	-	-	-	-	874	791	-	874	779	-
Platoon blocked, %	-	-	-	-	-	-	-	-	-	-	-	-
Mov Cap-1 Maneuver	1462	-	-	1485	-	-	673	640	964	694	634	933
Mov Cap-2 Maneuver	-	-	-	-	-	-	673	640	-	694	634	-
Stage 1	-	-	-	-	-	-	865	780	-	872	795	-
Stage 2	-	-	-	-	-	-	856	790	-	862	770	-

Approach	EB			WB			NB			SB		
HCM Control Delay, s	1.1			0.1			10.6			9.1		
HCM LOS							B			A		

Minor Lane/Major Mvmt	NBLn1	EBL	EBT	EBR	WBL	WBT	WBR	SBLn1
Capacity (veh/h)	679	1462	-	-	1485	-	-	900
HCM Lane V/C Ratio	0.054	0.013	-	-	0.001	-	-	0.023
HCM Control Delay (s)	10.6	7.5	-	-	7.4	-	-	9.1
HCM Lane LOS	B	A	-	-	A	-	-	A
HCM 95th %tile Q(veh)	0.2	0	-	-	0	-	-	0.1

HCM 6th TWSC
8: S Union Boulevard & Access B

Total Traffic Conditions
AM Peak Hour - Year 2026

Intersection						
Int Delay, s/veh	0.1					
Movement	WBL	WBR	NBT	NBR	SBL	SBT
Lane Configurations	↘↗		↑↓		↘	↑↑
Traffic Vol, veh/h	4	4	852	1	1	540
Future Vol, veh/h	4	4	852	1	1	540
Conflicting Peds, #/hr	0	0	0	0	0	0
Sign Control	Stop	Stop	Free	Free	Free	Free
RT Channelized	-	None	-	None	-	None
Storage Length	0	-	-	-	150	-
Veh in Median Storage, #	0	-	0	-	-	0
Grade, %	0	-	0	-	-	0
Peak Hour Factor	92	92	92	92	92	92
Heavy Vehicles, %	2	2	2	2	2	2
Mvmt Flow	4	4	926	1	1	587

Major/Minor	Minor1	Major1	Major2		
Conflicting Flow All	1223	464	0	0	927
Stage 1	927	-	-	-	-
Stage 2	296	-	-	-	-
Critical Hdwy	6.84	6.94	-	-	4.14
Critical Hdwy Stg 1	5.84	-	-	-	-
Critical Hdwy Stg 2	5.84	-	-	-	-
Follow-up Hdwy	3.52	3.32	-	-	2.22
Pot Cap-1 Maneuver	172	545	-	-	733
Stage 1	346	-	-	-	-
Stage 2	729	-	-	-	-
Platoon blocked, %			-	-	-
Mov Cap-1 Maneuver	172	545	-	-	733
Mov Cap-2 Maneuver	278	-	-	-	-
Stage 1	346	-	-	-	-
Stage 2	728	-	-	-	-

Approach	WB	NB	SB
HCM Control Delay, s	15	0	0
HCM LOS	C		

Minor Lane/Major Mvmt	NBT	NBRWBLn1	SBL	SBT
Capacity (veh/h)	-	-	368	733
HCM Lane V/C Ratio	-	-	0.024	0.001
HCM Control Delay (s)	-	-	15	9.9
HCM Lane LOS	-	-	C	A
HCM 95th %tile Q(veh)	-	-	0.1	0

HCM 6th TWSC
9: Access C & Airport Road

Total Traffic Conditions
AM Peak Hour - Year 2026

Intersection						
Int Delay, s/veh	0.1					
Movement	EBT	EBR	WBL	WBT	NBL	NBR
Lane Configurations	↔			↑		↗
Traffic Vol, veh/h	62	1	0	93	0	1
Future Vol, veh/h	62	1	0	93	0	1
Conflicting Peds, #/hr	0	0	0	0	0	0
Sign Control	Free	Free	Free	Free	Stop	Stop
RT Channelized	-	None	-	None	-	None
Storage Length	-	-	-	-	-	0
Veh in Median Storage, #	0	-	-	0	0	-
Grade, %	0	-	-	0	0	-
Peak Hour Factor	92	92	92	92	92	92
Heavy Vehicles, %	2	2	2	2	2	2
Mvmt Flow	67	1	0	101	0	1

Major/Minor	Major1	Major2	Minor1		
Conflicting Flow All	0	0	-	-	68
Stage 1	-	-	-	-	-
Stage 2	-	-	-	-	-
Critical Hdwy	-	-	-	-	6.22
Critical Hdwy Stg 1	-	-	-	-	-
Critical Hdwy Stg 2	-	-	-	-	-
Follow-up Hdwy	-	-	-	-	3.318
Pot Cap-1 Maneuver	-	0	-	0	995
Stage 1	-	0	-	0	-
Stage 2	-	0	-	0	-
Platoon blocked, %	-	-	-	-	-
Mov Cap-1 Maneuver	-	-	-	-	995
Mov Cap-2 Maneuver	-	-	-	-	-
Stage 1	-	-	-	-	-
Stage 2	-	-	-	-	-

Approach	EB	WB	NB
HCM Control Delay, s	0	0	8.6
HCM LOS			A

Minor Lane/Major Mvmt	NBLn1	EBT	EBR	WBT
Capacity (veh/h)	995	-	-	-
HCM Lane V/C Ratio	0.001	-	-	-
HCM Control Delay (s)	8.6	-	-	-
HCM Lane LOS	A	-	-	-
HCM 95th %tile Q(veh)	0	-	-	-

HCM 6th TWSC
10: Access D & Airport Road

Total Traffic Conditions
AM Peak Hour - Year 2026

Intersection						
Int Delay, s/veh	0.2					
Movement	EBT	EBR	WBL	WBT	NBL	NBR
Lane Configurations	↶		↷	↶	↷	
Traffic Vol, veh/h	62	1	1	90	3	0
Future Vol, veh/h	62	1	1	90	3	0
Conflicting Peds, #/hr	0	0	0	0	0	0
Sign Control	Free	Free	Free	Free	Stop	Stop
RT Channelized	-	None	-	None	-	None
Storage Length	-	-	150	-	0	-
Veh in Median Storage, #	0	-	-	0	0	-
Grade, %	0	-	-	0	0	-
Peak Hour Factor	92	92	92	92	92	92
Heavy Vehicles, %	2	2	2	2	2	2
Mvmt Flow	67	1	1	98	3	0

Major/Minor	Major1	Major2	Minor1		
Conflicting Flow All	0	0	68	0	168
Stage 1	-	-	-	-	68
Stage 2	-	-	-	-	100
Critical Hdwy	-	-	4.12	-	6.42
Critical Hdwy Stg 1	-	-	-	-	5.42
Critical Hdwy Stg 2	-	-	-	-	5.42
Follow-up Hdwy	-	-	2.218	-	3.518
Pot Cap-1 Maneuver	-	-	1533	-	822
Stage 1	-	-	-	-	955
Stage 2	-	-	-	-	924
Platoon blocked, %	-	-	-	-	-
Mov Cap-1 Maneuver	-	-	1533	-	821
Mov Cap-2 Maneuver	-	-	-	-	802
Stage 1	-	-	-	-	955
Stage 2	-	-	-	-	923

Approach	EB	WB	NB
HCM Control Delay, s	0	0.1	9.5
HCM LOS			A

Minor Lane/Major Mvmt	NBLn1	EBT	EBR	WBL	WBT
Capacity (veh/h)	802	-	-	1533	-
HCM Lane V/C Ratio	0.004	-	-	0.001	-
HCM Control Delay (s)	9.5	-	-	7.3	-
HCM Lane LOS	A	-	-	A	-
HCM 95th %tile Q(veh)	0	-	-	0	-

HCM 6th TWSC
11: Access E & Airport Road

Total Traffic Conditions
AM Peak Hour - Year 2026

Intersection						
Int Delay, s/veh	0.2					
Movement	EBT	EBR	WBL	WBT	NBL	NBR
Lane Configurations	↔		↔	↑	↔	
Traffic Vol, veh/h	62	0	0	89	2	1
Future Vol, veh/h	62	0	0	89	2	1
Conflicting Peds, #/hr	0	0	0	0	0	0
Sign Control	Free	Free	Free	Free	Stop	Stop
RT Channelized	-	None	-	None	-	None
Storage Length	-	-	150	-	0	-
Veh in Median Storage, #	0	-	-	0	0	-
Grade, %	0	-	-	0	0	-
Peak Hour Factor	92	92	92	92	92	92
Heavy Vehicles, %	2	2	2	2	2	2
Mvmt Flow	67	0	0	97	2	1

























Major/Minor	Major1	Major2	Minor1		
Conflicting Flow All	0	0	67	0	164
Stage 1	-	-	-	-	67
Stage 2	-	-	-	-	97
Critical Hdwy	-	-	4.12	-	6.42
Critical Hdwy Stg 1	-	-	-	-	5.42
Critical Hdwy Stg 2	-	-	-	-	5.42
Follow-up Hdwy	-	-	2.218	-	3.518
Pot Cap-1 Maneuver	-	-	1535	-	827
Stage 1	-	-	-	-	956
Stage 2	-	-	-	-	927
Platoon blocked, %	-	-	-	-	-
Mov Cap-1 Maneuver	-	-	1535	-	827
Mov Cap-2 Maneuver	-	-	-	-	806
Stage 1	-	-	-	-	956
Stage 2	-	-	-	-	927

Approach	EB	WB	NB
HCM Control Delay, s	0	0	9.2
HCM LOS			A

Minor Lane/Major Mvmt	NBLn1	EBT	EBR	WBL	WBT
Capacity (veh/h)	861	-	-	1535	-
HCM Lane V/C Ratio	0.004	-	-	-	-
HCM Control Delay (s)	9.2	-	-	0	-
HCM Lane LOS	A	-	-	A	-
HCM 95th %tile Q(veh)	0	-	-	0	-

Timings
1: S Union Boulevard & Eastlake Boulevard

Total Traffic Conditions
PM Peak Hour - Year 2026

												
Lane Group	EBL	EBT	EBR	WBL	WBT	WBR	NBL	NBT	NBR	SBL	SBT	SBR
Lane Configurations												
Traffic Volume (vph)	56	80	18	55	59	14	10	616	29	33	779	55
Future Volume (vph)	56	80	18	55	59	14	10	616	29	33	779	55
Satd. Flow (prot)	1770	1863	1583	1770	1863	1583	1770	3514	0	1770	3539	1583
Flt Permitted	0.715			0.701			0.328			0.385		
Satd. Flow (perm)	1332	1863	1583	1306	1863	1583	611	3514	0	717	3539	1583
Satd. Flow (RTOR)			45			45		11				55
Lane Group Flow (vph)	61	87	20	60	64	15	11	702	0	36	847	60
Turn Type	Perm	NA	Perm	Perm	NA	Perm	Perm	NA		Perm	NA	Perm
Protected Phases		4			8			2			6	
Permitted Phases	4		4	8		8	2			6		6
Detector Phase	4	4	4	8	8	8	2	2		6	6	6
Switch Phase												
Minimum Initial (s)	4.0	4.0	4.0	4.0	4.0	4.0	4.0	4.0		4.0	4.0	4.0
Minimum Split (s)	10.0	10.0	10.0	10.0	10.0	10.0	9.5	9.5		9.5	9.5	9.5
Total Split (s)	25.0	25.0	25.0	25.0	25.0	25.0	35.0	35.0		35.0	35.0	35.0
Total Split (%)	41.7%	41.7%	41.7%	41.7%	41.7%	41.7%	58.3%	58.3%		58.3%	58.3%	58.3%
Yellow Time (s)	4.0	4.0	4.0	4.0	4.0	4.0	3.5	3.5		3.5	3.5	3.5
All-Red Time (s)	2.0	2.0	2.0	2.0	2.0	2.0	2.0	2.0		2.0	2.0	2.0
Lost Time Adjust (s)	0.0	0.0	0.0	0.0	0.0	0.0	0.0	0.0		0.0	0.0	0.0
Total Lost Time (s)	6.0	6.0	6.0	6.0	6.0	6.0	5.5	5.5		5.5	5.5	5.5
Lead/Lag												
Lead-Lag Optimize?												
Recall Mode	None	None	None	None	None	None	C-Max	C-Max		C-Max	C-Max	C-Max
Act Effct Green (s)	8.3	8.3	8.3	8.3	8.3	8.3	43.6	43.6		43.6	43.6	43.6
Actuated g/C Ratio	0.14	0.14	0.14	0.14	0.14	0.14	0.73	0.73		0.73	0.73	0.73
v/c Ratio	0.33	0.34	0.08	0.33	0.25	0.06	0.02	0.27		0.07	0.33	0.05
Control Delay	27.4	26.1	3.6	27.5	24.5	2.0	4.4	4.3		4.6	4.7	1.8
Queue Delay	0.0	0.0	0.0	0.0	0.0	0.0	0.0	0.0		0.0	0.0	0.0
Total Delay	27.4	26.1	3.6	27.5	24.5	2.0	4.4	4.3		4.6	4.7	1.8
LOS	C	C	A	C	C	A	A	A		A	A	A
Approach Delay		23.9			23.4			4.3			4.5	
Approach LOS		C			C			A			A	
Queue Length 50th (ft)	20	29	0	20	21	0	1	42		4	55	1
Queue Length 95th (ft)	48	61	7	47	48	4	6	77		14	98	11
Internal Link Dist (ft)		416			208			351			224	
Turn Bay Length (ft)	65		60	40		40	100			125		30
Base Capacity (vph)	421	589	532	413	589	532	443	2555		520	2570	1164
Starvation Cap Reductn	0	0	0	0	0	0	0	0		0	0	0
Spillback Cap Reductn	0	0	0	0	0	0	0	0		0	0	0
Storage Cap Reductn	0	0	0	0	0	0	0	0		0	0	0
Reduced v/c Ratio	0.14	0.15	0.04	0.15	0.11	0.03	0.02	0.27		0.07	0.33	0.05
Intersection Summary												
Cycle Length: 60												
Actuated Cycle Length: 60												
Offset: 0 (0%), Referenced to phase 2:NBTL and 6:SBTL, Start of Green												
Natural Cycle: 40												
Control Type: Actuated-Coordinated												

Timings
 1: S Union Boulevard & Eastlake Boulevard

Total Traffic Conditions
 PM Peak Hour - Year 2026

Maximum v/c Ratio: 0.34	
Intersection Signal Delay: 7.4	Intersection LOS: A
Intersection Capacity Utilization 46.8%	ICU Level of Service A
Analysis Period (min) 15	

Splits and Phases: 1: S Union Boulevard & Eastlake Boulevard

 Ø2 (R) 35 s	 Ø4 25 s
 Ø6 (R) 35 s	 Ø8 25 s

HCM 6th TWSC
2: S Union Boulevard & Airport Road

Total Traffic Conditions
PM Peak Hour - Year 2026

Intersection						
Int Delay, s/veh	0.9					
Movement	WBL	WBR	NBT	NBR	SBL	SBT
Lane Configurations	↘	↗	↑↑	↗	↘	↑↑
Traffic Vol, veh/h	27	51	663	25	76	826
Future Vol, veh/h	27	51	663	25	76	826
Conflicting Peds, #/hr	0	0	0	0	0	0
Sign Control	Stop	Stop	Free	Free	Free	Free
RT Channelized	-	None	-	None	-	None
Storage Length	0	70	-	60	350	-
Veh in Median Storage, #	0	-	0	-	-	0
Grade, %	0	-	0	-	-	0
Peak Hour Factor	92	92	92	92	92	92
Heavy Vehicles, %	2	2	2	2	2	2
Mvmt Flow	29	55	721	27	83	898

Major/Minor	Minor1	Major1	Major2		
Conflicting Flow All	1336	361	0	0	748
Stage 1	721	-	-	-	-
Stage 2	615	-	-	-	-
Critical Hdwy	6.84	6.94	-	-	4.14
Critical Hdwy Stg 1	5.84	-	-	-	-
Critical Hdwy Stg 2	5.84	-	-	-	-
Follow-up Hdwy	3.52	3.32	-	-	2.22
Pot Cap-1 Maneuver	*248	*814	-	-	1216
Stage 1	*768	-	-	-	-
Stage 2	*502	-	-	-	-
Platoon blocked, %	1	1	-	-	1
Mov Cap-1 Maneuver	*231	*814	-	-	1216
Mov Cap-2 Maneuver	*361	-	-	-	-
Stage 1	*768	-	-	-	-
Stage 2	*468	-	-	-	-

Approach	WB	NB	SB
HCM Control Delay, s	11.8	0	0.7
HCM LOS	B		

Minor Lane/Major Mvmt	NBT	NBR	WBLn1	WBLn2	SBL	SBT
Capacity (veh/h)	-	-	361	814	1216	-
HCM Lane V/C Ratio	-	-	0.081	0.068	0.068	-
HCM Control Delay (s)	-	-	15.9	9.7	8.2	-
HCM Lane LOS	-	-	C	A	A	-
HCM 95th %tile Q(veh)	-	-	0.3	0.2	0.2	-

Notes
 ~: Volume exceeds capacity \$: Delay exceeds 300s +: Computation Not Defined *: All major volume in platoon

HCM 6th TWSC
3: Eastlake Boulevard & Airport Road

Total Traffic Conditions
PM Peak Hour - Year 2026

Intersection						
Int Delay, s/veh	4.7					
Movement	EBT	EBR	WBL	WBT	NEL	NER
Lane Configurations	↶		↷	↶	↷	↷
Traffic Vol, veh/h	90	11	102	75	4	110
Future Vol, veh/h	90	11	102	75	4	110
Conflicting Peds, #/hr	0	0	0	0	0	0
Sign Control	Free	Free	Free	Free	Stop	Stop
RT Channelized	-	None	-	None	-	None
Storage Length	-	-	400	-	80	-
Veh in Median Storage, #	0	-	-	0	0	-
Grade, %	0	-	-	0	0	-
Peak Hour Factor	92	92	92	92	92	92
Heavy Vehicles, %	2	2	2	2	2	2
Mvmt Flow	98	12	111	82	4	120
Major/Minor	Major1	Major2	Minor1			
Conflicting Flow All	0	0	110	0	408	104
Stage 1	-	-	-	-	104	-
Stage 2	-	-	-	-	304	-
Critical Hdwy	-	-	4.12	-	6.42	6.22
Critical Hdwy Stg 1	-	-	-	-	5.42	-
Critical Hdwy Stg 2	-	-	-	-	5.42	-
Follow-up Hdwy	-	-	2.218	-	3.518	3.318
Pot Cap-1 Maneuver	-	-	1480	-	599	951
Stage 1	-	-	-	-	920	-
Stage 2	-	-	-	-	748	-
Platoon blocked, %	-	-	-	-	-	-
Mov Cap-1 Maneuver	-	-	1480	-	554	951
Mov Cap-2 Maneuver	-	-	-	-	597	-
Stage 1	-	-	-	-	920	-
Stage 2	-	-	-	-	692	-
Approach	EB	WB	NE			
HCM Control Delay, s	0	4.4	9.4			
HCM LOS			A			
Minor Lane/Major Mvmt	NELn1	NELn2	EBT	EBR	WBL	WBT
Capacity (veh/h)	597	951	-	-	1480	-
HCM Lane V/C Ratio	0.007	0.126	-	-	0.075	-
HCM Control Delay (s)	11.1	9.3	-	-	7.6	-
HCM Lane LOS	B	A	-	-	A	-
HCM 95th %tile Q(veh)	0	0.4	-	-	0.2	-

HCM 6th TWSC
4: Eastlake Boulevard & Salt Drive

Total Traffic Conditions
PM Peak Hour - Year 2026

Intersection						
Int Delay, s/veh	0.3					
Movement	NWL	NWR	NET	NER	SWL	SWT
Lane Configurations	T		T		T	
Traffic Vol, veh/h	4	3	108	3	2	111
Future Vol, veh/h	4	3	108	3	2	111
Conflicting Peds, #/hr	0	0	0	0	0	0
Sign Control	Stop	Stop	Free	Free	Free	Free
RT Channelized	-	None	-	None	-	None
Storage Length	0	-	-	-	-	-
Veh in Median Storage, #	0	-	0	-	-	0
Grade, %	0	-	0	-	-	0
Peak Hour Factor	92	92	92	92	92	92
Heavy Vehicles, %	2	2	2	2	2	2
Mvmt Flow	4	3	117	3	2	121

Major/Minor	Minor1	Major1	Major2			
Conflicting Flow All	244	119	0	0	120	0
Stage 1	119	-	-	-	-	-
Stage 2	125	-	-	-	-	-
Critical Hdwy	6.42	6.22	-	-	4.12	-
Critical Hdwy Stg 1	5.42	-	-	-	-	-
Critical Hdwy Stg 2	5.42	-	-	-	-	-
Follow-up Hdwy	3.518	3.318	-	-	2.218	-
Pot Cap-1 Maneuver	744	933	-	-	1468	-
Stage 1	906	-	-	-	-	-
Stage 2	901	-	-	-	-	-
Platoon blocked, %			-	-		-
Mov Cap-1 Maneuver	743	933	-	-	1468	-
Mov Cap-2 Maneuver	751	-	-	-	-	-
Stage 1	906	-	-	-	-	-
Stage 2	900	-	-	-	-	-

Approach	NW	NE	SW
HCM Control Delay, s	9.4	0	0.1
HCM LOS	A		

Minor Lane/Major Mvmt	NET	NERNWLn1	SWL	SWT
Capacity (veh/h)	-	-	820	1468
HCM Lane V/C Ratio	-	-	0.009	0.001
HCM Control Delay (s)	-	-	9.4	7.5
HCM Lane LOS	-	-	A	A
HCM 95th %tile Q(veh)	-	-	0	0

HCM 6th TWSC
5: Eastlake Boulevard & Huron Road

Total Traffic Conditions
PM Peak Hour - Year 2026

Intersection						
Int Delay, s/veh	0.4					
Movement	WBL	WBR	NET	NER	SWL	SWT
Lane Configurations	↘↗		↖↗		↘↗	↖↗
Traffic Vol, veh/h	4	1	110	9	7	108
Future Vol, veh/h	4	1	110	9	7	108
Conflicting Peds, #/hr	0	0	0	0	0	0
Sign Control	Stop	Stop	Free	Free	Free	Free
RT Channelized	-	None	-	None	-	None
Storage Length	0	-	-	-	200	-
Veh in Median Storage, #	0	-	0	-	-	0
Grade, %	0	-	0	-	-	0
Peak Hour Factor	92	92	92	92	92	92
Heavy Vehicles, %	2	2	2	2	2	2
Mvmt Flow	4	1	120	10	8	117

Major/Minor	Minor1	Major1	Major2		
Conflicting Flow All	258	125	0	0	130
Stage 1	125	-	-	-	-
Stage 2	133	-	-	-	-
Critical Hdwy	6.42	6.22	-	-	4.12
Critical Hdwy Stg 1	5.42	-	-	-	-
Critical Hdwy Stg 2	5.42	-	-	-	-
Follow-up Hdwy	3.518	3.318	-	-	2.218
Pot Cap-1 Maneuver	731	926	-	-	1455
Stage 1	901	-	-	-	-
Stage 2	893	-	-	-	-
Platoon blocked, %			-	-	-
Mov Cap-1 Maneuver	727	926	-	-	1455
Mov Cap-2 Maneuver	727	-	-	-	-
Stage 1	901	-	-	-	-
Stage 2	889	-	-	-	-

Approach	WB	NE	SW
HCM Control Delay, s	9.8	0	0.5
HCM LOS	A		

Minor Lane/Major Mvmt	NET	NERWBLn1	SWL	SWT
Capacity (veh/h)	-	-	760	1455
HCM Lane V/C Ratio	-	-	0.007	0.005
HCM Control Delay (s)	-	-	9.8	7.5
HCM Lane LOS	-	-	A	A
HCM 95th %tile Q(veh)	-	-	0	0

HCM 6th TWSC
6: Eastlake Boulevard & Erie Road

Total Traffic Conditions
PM Peak Hour - Year 2026

Intersection						
Int Delay, s/veh	0.3					
Movement	NWL	NWR	NET	NER	SWL	SWT
Lane Configurations	↙↘		↕		↙↘	↕
Traffic Vol, veh/h	4	2	118	7	2	110
Future Vol, veh/h	4	2	118	7	2	110
Conflicting Peds, #/hr	0	0	0	0	0	0
Sign Control	Stop	Stop	Free	Free	Free	Free
RT Channelized	-	None	-	None	-	None
Storage Length	0	-	-	-	180	-
Veh in Median Storage, #	0	-	0	-	-	0
Grade, %	0	-	0	-	-	0
Peak Hour Factor	92	92	92	92	92	92
Heavy Vehicles, %	2	2	2	2	2	2
Mvmt Flow	4	2	128	8	2	120

Major/Minor	Minor1	Major1	Major2			
Conflicting Flow All	256	132	0	0	136	0
Stage 1	132	-	-	-	-	-
Stage 2	124	-	-	-	-	-
Critical Hdwy	6.42	6.22	-	-	4.12	-
Critical Hdwy Stg 1	5.42	-	-	-	-	-
Critical Hdwy Stg 2	5.42	-	-	-	-	-
Follow-up Hdwy	3.518	3.318	-	-	2.218	-
Pot Cap-1 Maneuver	733	917	-	-	1448	-
Stage 1	894	-	-	-	-	-
Stage 2	902	-	-	-	-	-
Platoon blocked, %			-	-		-
Mov Cap-1 Maneuver	732	917	-	-	1448	-
Mov Cap-2 Maneuver	744	-	-	-	-	-
Stage 1	894	-	-	-	-	-
Stage 2	901	-	-	-	-	-

Approach	NW	NE	SW
HCM Control Delay, s	9.6	0	0.1
HCM LOS	A		

Minor Lane/Major Mvmt	NET	NERNWLn1	SWL	SWT
Capacity (veh/h)	-	-	794	1448
HCM Lane V/C Ratio	-	-	0.008	0.002
HCM Control Delay (s)	-	-	9.6	7.5
HCM Lane LOS	-	-	A	A
HCM 95th %tile Q(veh)	-	-	0	0

HCM 6th TWSC
7: Manitoba Drive/Access A & Eastlake Boulevard

Total Traffic Conditions
PM Peak Hour - Year 2026

Intersection												
Int Delay, s/veh	1.5											
Movement	EBL	EBT	EBR	WBL	WBT	WBR	NBL	NBT	NBR	SBL	SBT	SBR
Lane Configurations	↖	↗		↖	↗			↕			↕	
Traffic Vol, veh/h	5	115	22	2	109	3	10	0	2	7	0	22
Future Vol, veh/h	5	115	22	2	109	3	10	0	2	7	0	22
Conflicting Peds, #/hr	0	0	0	0	0	0	0	0	0	0	0	0
Sign Control	Free	Free	Free	Free	Free	Free	Stop	Stop	Stop	Stop	Stop	Stop
RT Channelized	-	-	None	-	-	None	-	-	None	-	-	None
Storage Length	105	-	-	170	-	-	-	-	-	-	-	-
Veh in Median Storage, #	-	0	-	-	0	-	-	0	-	-	0	-
Grade, %	-	0	-	-	0	-	-	0	-	-	0	-
Peak Hour Factor	92	92	92	92	92	92	92	92	92	92	92	92
Heavy Vehicles, %	2	2	2	2	2	2	2	2	2	2	2	2
Mvmt Flow	5	125	24	2	118	3	11	0	2	8	0	24

Major/Minor	Major1		Major2		Minor1			Minor2				
Conflicting Flow All	121	0	0	149	0	0	283	272	137	272	283	120
Stage 1	-	-	-	-	-	-	147	147	-	124	124	-
Stage 2	-	-	-	-	-	-	136	125	-	148	159	-
Critical Hdwy	4.12	-	-	4.12	-	-	7.12	6.52	6.22	7.12	6.52	6.22
Critical Hdwy Stg 1	-	-	-	-	-	-	6.12	5.52	-	6.12	5.52	-
Critical Hdwy Stg 2	-	-	-	-	-	-	6.12	5.52	-	6.12	5.52	-
Follow-up Hdwy	2.218	-	-	2.218	-	-	3.518	4.018	3.318	3.518	4.018	3.318
Pot Cap-1 Maneuver	1467	-	-	1432	-	-	669	635	911	680	626	931
Stage 1	-	-	-	-	-	-	856	775	-	880	793	-
Stage 2	-	-	-	-	-	-	867	792	-	855	766	-
Platoon blocked, %	-	-	-	-	-	-	-	-	-	-	-	-
Mov Cap-1 Maneuver	1467	-	-	1432	-	-	650	632	911	676	623	931
Mov Cap-2 Maneuver	-	-	-	-	-	-	650	632	-	676	623	-
Stage 1	-	-	-	-	-	-	853	773	-	877	792	-
Stage 2	-	-	-	-	-	-	844	791	-	850	764	-

Approach	EB	WB	NB	SB
HCM Control Delay, s	0.3	0.1	10.4	9.4
HCM LOS			B	A

Minor Lane/Major Mvmt	NBLn1	EBL	EBT	EBR	WBL	WBT	WBR	SBLn1
Capacity (veh/h)	683	1467	-	-	1432	-	-	853
HCM Lane V/C Ratio	0.019	0.004	-	-	0.002	-	-	0.037
HCM Control Delay (s)	10.4	7.5	-	-	7.5	-	-	9.4
HCM Lane LOS	B	A	-	-	A	-	-	A
HCM 95th %tile Q(veh)	0.1	0	-	-	0	-	-	0.1

HCM 6th TWSC
8: S Union Boulevard & Access B

Total Traffic Conditions
PM Peak Hour - Year 2026

Intersection						
Int Delay, s/veh	0					
Movement	WBL	WBR	NBT	NBR	SBL	SBT
Lane Configurations	↘↗		↑↓		↘	↑↑
Traffic Vol, veh/h	2	2	683	3	3	850
Future Vol, veh/h	2	2	683	3	3	850
Conflicting Peds, #/hr	0	0	0	0	0	0
Sign Control	Stop	Stop	Free	Free	Free	Free
RT Channelized	-	None	-	None	-	None
Storage Length	0	-	-	-	150	-
Veh in Median Storage, #	0	-	0	-	-	0
Grade, %	0	-	0	-	-	0
Peak Hour Factor	92	92	92	92	92	92
Heavy Vehicles, %	2	2	2	2	2	2
Mvmt Flow	2	2	742	3	3	924

Major/Minor	Minor1	Major1	Major2		
Conflicting Flow All	1212	373	0	0	745
Stage 1	744	-	-	-	-
Stage 2	468	-	-	-	-
Critical Hdwy	6.84	6.94	-	-	4.14
Critical Hdwy Stg 1	5.84	-	-	-	-
Critical Hdwy Stg 2	5.84	-	-	-	-
Follow-up Hdwy	3.52	3.32	-	-	2.22
Pot Cap-1 Maneuver	175	624	-	-	859
Stage 1	431	-	-	-	-
Stage 2	597	-	-	-	-
Platoon blocked, %			-	-	-
Mov Cap-1 Maneuver	174	624	-	-	859
Mov Cap-2 Maneuver	304	-	-	-	-
Stage 1	431	-	-	-	-
Stage 2	595	-	-	-	-

Approach	WB	NB	SB
HCM Control Delay, s	13.9	0	0
HCM LOS	B		

Minor Lane/Major Mvmt	NBT	NBRWBLn1	SBL	SBT
Capacity (veh/h)	-	-	409	859
HCM Lane V/C Ratio	-	-	0.011	0.004
HCM Control Delay (s)	-	-	13.9	9.2
HCM Lane LOS	-	-	B	A
HCM 95th %tile Q(veh)	-	-	0	0

HCM 6th TWSC
9: Access C & Airport Road

Total Traffic Conditions
PM Peak Hour - Year 2026

Intersection						
Int Delay, s/veh	0					
Movement	EBT	EBR	WBL	WBT	NBL	NBR
Lane Configurations	↔			↑		↗
Traffic Vol, veh/h	98	3	0	82	0	1
Future Vol, veh/h	98	3	0	82	0	1
Conflicting Peds, #/hr	0	0	0	0	0	0
Sign Control	Free	Free	Free	Free	Stop	Stop
RT Channelized	-	None	-	None	-	None
Storage Length	-	-	-	-	-	0
Veh in Median Storage, #	0	-	-	0	0	-
Grade, %	0	-	-	0	0	-
Peak Hour Factor	92	92	92	92	92	92
Heavy Vehicles, %	2	2	2	2	2	2
Mvmt Flow	107	3	0	89	0	1

Major/Minor	Major1	Major2	Minor1			
Conflicting Flow All	0	0	-	-	-	109
Stage 1	-	-	-	-	-	-
Stage 2	-	-	-	-	-	-
Critical Hdwy	-	-	-	-	-	6.22
Critical Hdwy Stg 1	-	-	-	-	-	-
Critical Hdwy Stg 2	-	-	-	-	-	-
Follow-up Hdwy	-	-	-	-	-	3.318
Pot Cap-1 Maneuver	-	-	0	-	0	945
Stage 1	-	-	0	-	0	-
Stage 2	-	-	0	-	0	-
Platoon blocked, %	-	-	-	-	-	-
Mov Cap-1 Maneuver	-	-	-	-	-	945
Mov Cap-2 Maneuver	-	-	-	-	-	-
Stage 1	-	-	-	-	-	-
Stage 2	-	-	-	-	-	-

Approach	EB	WB	NB
HCM Control Delay, s	0	0	8.8
HCM LOS			A

Minor Lane/Major Mvmt	NBLn1	EBT	EBR	WBT
Capacity (veh/h)	945	-	-	-
HCM Lane V/C Ratio	0.001	-	-	-
HCM Control Delay (s)	8.8	-	-	-
HCM Lane LOS	A	-	-	-
HCM 95th %tile Q(veh)	0	-	-	-

HCM 6th TWSC
10: Access D & Airport Road

Total Traffic Conditions
PM Peak Hour - Year 2026

Intersection						
Int Delay, s/veh	0.1					
Movement	EBT	EBR	WBL	WBT	NBL	NBR
Lane Configurations	↗		↖	↑	↘	
Traffic Vol, veh/h	97	2	1	81	1	0
Future Vol, veh/h	97	2	1	81	1	0
Conflicting Peds, #/hr	0	0	0	0	0	0
Sign Control	Free	Free	Free	Free	Stop	Stop
RT Channelized	-	None	-	None	-	None
Storage Length	-	-	150	-	0	-
Veh in Median Storage, #	0	-	-	0	0	-
Grade, %	0	-	-	0	0	-
Peak Hour Factor	92	92	92	92	92	92
Heavy Vehicles, %	2	2	2	2	2	2
Mvmt Flow	105	2	1	88	1	0

Major/Minor	Major1	Major2	Minor1		
Conflicting Flow All	0	0	107	0	196
Stage 1	-	-	-	-	106
Stage 2	-	-	-	-	90
Critical Hdwy	-	-	4.12	-	6.42
Critical Hdwy Stg 1	-	-	-	-	5.42
Critical Hdwy Stg 2	-	-	-	-	5.42
Follow-up Hdwy	-	-	2.218	-	3.518
Pot Cap-1 Maneuver	-	-	1484	-	793
Stage 1	-	-	-	-	918
Stage 2	-	-	-	-	934
Platoon blocked, %	-	-	-	-	-
Mov Cap-1 Maneuver	-	-	1484	-	792
Mov Cap-2 Maneuver	-	-	-	-	784
Stage 1	-	-	-	-	918
Stage 2	-	-	-	-	933

Approach	EB	WB	NB
HCM Control Delay, s	0	0.1	9.6
HCM LOS			A

Minor Lane/Major Mvmt	NBLn1	EBT	EBR	WBL	WBT
Capacity (veh/h)	784	-	-	1484	-
HCM Lane V/C Ratio	0.001	-	-	0.001	-
HCM Control Delay (s)	9.6	-	-	7.4	-
HCM Lane LOS	A	-	-	A	-
HCM 95th %tile Q(veh)	0	-	-	0	-

HCM 6th TWSC
11: Access E & Airport Road

Total Traffic Conditions
PM Peak Hour - Year 2026

Intersection						
Int Delay, s/veh	0.1					
Movement	EBT	EBR	WBL	WBT	NBL	NBR
Lane Configurations	↗		↖	↑	↘	
Traffic Vol, veh/h	97	0	1	81	1	1
Future Vol, veh/h	97	0	1	81	1	1
Conflicting Peds, #/hr	0	0	0	0	0	0
Sign Control	Free	Free	Free	Free	Stop	Stop
RT Channelized	-	None	-	None	-	None
Storage Length	-	-	150	-	0	-
Veh in Median Storage, #	0	-	-	0	0	-
Grade, %	0	-	-	0	0	-
Peak Hour Factor	92	92	92	92	92	92
Heavy Vehicles, %	2	2	2	2	2	2
Mvmt Flow	105	0	1	88	1	1

























Major/Minor	Major1	Major2	Minor1		
Conflicting Flow All	0	0	105	0	195
Stage 1	-	-	-	-	105
Stage 2	-	-	-	-	90
Critical Hdwy	-	-	4.12	-	6.42
Critical Hdwy Stg 1	-	-	-	-	5.42
Critical Hdwy Stg 2	-	-	-	-	5.42
Follow-up Hdwy	-	-	2.218	-	3.518
Pot Cap-1 Maneuver	-	-	1486	-	794
Stage 1	-	-	-	-	919
Stage 2	-	-	-	-	934
Platoon blocked, %	-	-	-	-	-
Mov Cap-1 Maneuver	-	-	1486	-	793
Mov Cap-2 Maneuver	-	-	-	-	784
Stage 1	-	-	-	-	919
Stage 2	-	-	-	-	933

Approach	EB	WB	NB
HCM Control Delay, s	0	0.1	9.2
HCM LOS			A

Minor Lane/Major Mvmt	NBLn1	EBT	EBR	WBL	WBT
Capacity (veh/h)	859	-	-	1486	-
HCM Lane V/C Ratio	0.003	-	-	0.001	-
HCM Control Delay (s)	9.2	-	-	7.4	-
HCM Lane LOS	A	-	-	A	-
HCM 95th %tile Q(veh)	0	-	-	0	-

Timings
1: S Union Boulevard & Eastlake Boulevard

Total Traffic Conditions
AM Peak Hour - Year 2044





												
Lane Group	EBL	EBT	EBR	WBL	WBT	WBR	NBL	NBT	NBR	SBL	SBT	SBR
Lane Configurations												
Traffic Volume (vph)	56	97	30	101	97	41	17	1154	74	20	683	47
Future Volume (vph)	56	97	30	101	97	41	17	1154	74	20	683	47
Satd. Flow (prot)	1770	1863	1583	1770	1863	1583	1770	3507	0	1770	3539	1583
Flt Permitted	0.689			0.689			0.370			0.169		
Satd. Flow (perm)	1283	1863	1583	1283	1863	1583	689	3507	0	315	3539	1583
Satd. Flow (RTOR)			45			45		21				55
Lane Group Flow (vph)	61	105	33	110	105	45	18	1334	0	22	742	51
Turn Type	Perm	NA	Perm	Perm	NA	Perm	Perm	NA		Perm	NA	Perm
Protected Phases		4			8			2				6
Permitted Phases	4		4	8		8	2			6		6
Detector Phase	4	4	4	8	8	8	2	2		6	6	6
Switch Phase												
Minimum Initial (s)	4.0	4.0	4.0	4.0	4.0	4.0	4.0	4.0		4.0	4.0	4.0
Minimum Split (s)	10.0	10.0	10.0	10.0	10.0	10.0	9.5	9.5		9.5	9.5	9.5
Total Split (s)	17.0	17.0	17.0	17.0	17.0	17.0	43.0	43.0		43.0	43.0	43.0
Total Split (%)	28.3%	28.3%	28.3%	28.3%	28.3%	28.3%	71.7%	71.7%		71.7%	71.7%	71.7%
Yellow Time (s)	4.0	4.0	4.0	4.0	4.0	4.0	3.5	3.5		3.5	3.5	3.5
All-Red Time (s)	2.0	2.0	2.0	2.0	2.0	2.0	2.0	2.0		2.0	2.0	2.0
Lost Time Adjust (s)	0.0	0.0	0.0	0.0	0.0	0.0	0.0	0.0		0.0	0.0	0.0
Total Lost Time (s)	6.0	6.0	6.0	6.0	6.0	6.0	5.5	5.5		5.5	5.5	5.5
Lead/Lag												
Lead-Lag Optimize?												
Recall Mode	None	None	None	None	None	None	C-Max	C-Max		C-Max	C-Max	C-Max
Act Effct Green (s)	9.2	9.2	9.2	9.3	9.3	9.3	42.7	42.7		42.7	42.7	42.7
Actuated g/C Ratio	0.15	0.15	0.15	0.16	0.16	0.16	0.71	0.71		0.71	0.71	0.71
v/c Ratio	0.31	0.37	0.12	0.56	0.37	0.16	0.04	0.53		0.10	0.29	0.04
Control Delay	26.1	25.8	6.9	34.1	25.8	9.1	4.6	6.6		5.9	4.9	1.5
Queue Delay	0.0	0.0	0.0	0.0	0.0	0.0	0.0	0.0		0.0	0.0	0.0
Total Delay	26.1	25.8	6.9	34.1	25.8	9.1	4.6	6.6		5.9	4.9	1.5
LOS	C	C	A	C	C	A	A	A		A	A	A
Approach Delay		22.8			26.4			6.5				4.7
Approach LOS		C			C			A				A
Queue Length 50th (ft)	19	34	0	37	34	0	2	122		3	54	0
Queue Length 95th (ft)	49	72	16	79	72	23	8	178		11	82	9
Internal Link Dist (ft)		416			59			351				235
Turn Bay Length (ft)	65		60	40		40	100			125		30
Base Capacity (vph)	235	341	326	235	341	326	489	2499		223	2516	1141
Starvation Cap Reductn	0	0	0	0	0	0	0	0		0	0	0
Spillback Cap Reductn	0	0	0	0	0	0	0	0		0	0	0
Storage Cap Reductn	0	0	0	0	0	0	0	0		0	0	0
Reduced v/c Ratio	0.26	0.31	0.10	0.47	0.31	0.14	0.04	0.53		0.10	0.29	0.04
Intersection Summary												
Cycle Length: 60												
Actuated Cycle Length: 60												
Offset: 0 (0%), Referenced to phase 2:NBTL and 6:SBTL, Start of Green												
Natural Cycle: 40												
Control Type: Actuated-Coordinated												

Timings
 1: S Union Boulevard & Eastlake Boulevard

Total Traffic Conditions
 AM Peak Hour - Year 2044

Maximum v/c Ratio: 0.56	
Intersection Signal Delay: 9.2	Intersection LOS: A
Intersection Capacity Utilization 56.1%	ICU Level of Service B
Analysis Period (min) 15	

Splits and Phases: 1: S Union Boulevard & Eastlake Boulevard

 Ø2 (R) 43 s	 Ø4 17 s
 Ø6 (R) 43 s	 Ø8 17 s

HCM 6th TWSC
2: S Union Boulevard & Airport Road

Total Traffic Conditions
AM Peak Hour - Year 2044

Intersection						
Int Delay, s/veh	1.3					
Movement	WBL	WBR	NBT	NBR	SBL	SBT
Lane Configurations	↘	↗	↑↑	↗	↘	↑↑
Traffic Vol, veh/h	32	126	1211	35	80	768
Future Vol, veh/h	32	126	1211	35	80	768
Conflicting Peds, #/hr	0	0	0	0	0	0
Sign Control	Stop	Stop	Free	Free	Free	Free
RT Channelized	-	None	-	None	-	None
Storage Length	0	70	-	60	350	-
Veh in Median Storage, #	0	-	0	-	-	0
Grade, %	0	-	0	-	-	0
Peak Hour Factor	92	92	92	92	92	92
Heavy Vehicles, %	2	2	2	2	2	2
Mvmt Flow	35	137	1316	38	87	835

Major/Minor	Minor1	Major1	Major2		
Conflicting Flow All	1908	658	0	0	1354
Stage 1	1316	-	-	-	-
Stage 2	592	-	-	-	-
Critical Hdwy	6.84	6.94	-	-	4.14
Critical Hdwy Stg 1	5.84	-	-	-	-
Critical Hdwy Stg 2	5.84	-	-	-	-
Follow-up Hdwy	3.52	3.32	-	-	2.22
Pot Cap-1 Maneuver	124	*609	-	-	859
Stage 1	573	-	-	-	-
Stage 2	516	-	-	-	-
Platoon blocked, %	1	1	-	-	1
Mov Cap-1 Maneuver	111	*609	-	-	859
Mov Cap-2 Maneuver	284	-	-	-	-
Stage 1	573	-	-	-	-
Stage 2	464	-	-	-	-

Approach	WB	NB	SB
HCM Control Delay, s	14	0	0.9
HCM LOS	B		

Minor Lane/Major Mvmt	NBT	NBR	WBLn1	WBLn2	SBL	SBT
Capacity (veh/h)	-	-	284	609	859	-
HCM Lane V/C Ratio	-	-	0.122	0.225	0.101	-
HCM Control Delay (s)	-	-	19.4	12.6	9.7	-
HCM Lane LOS	-	-	C	B	A	-
HCM 95th %tile Q(veh)	-	-	0.4	0.9	0.3	-

Notes
 ~: Volume exceeds capacity \$: Delay exceeds 300s +: Computation Not Defined *: All major volume in platoon

HCM 6th TWSC
3: Eastlake Boulevard & Airport Road

Total Traffic Conditions
AM Peak Hour - Year 2044

Intersection

Int Delay, s/veh 4.7

Movement	EBT	EBR	WBL	WBT	NEL	NER
Lane Configurations	↔		↔	↔	↔	↔
Traffic Vol, veh/h	90	3	147	128	11	108
Future Vol, veh/h	90	3	147	128	11	108
Conflicting Peds, #/hr	0	0	0	0	0	0
Sign Control	Free	Free	Free	Free	Stop	Stop
RT Channelized	-	None	-	None	-	None
Storage Length	-	-	400	-	80	-
Veh in Median Storage, #	0	-	-	0	0	-
Grade, %	0	-	-	0	0	-
Peak Hour Factor	92	92	92	92	92	92
Heavy Vehicles, %	2	2	2	2	2	2
Mvmt Flow	98	3	160	139	12	117

Major/Minor	Major1	Major2	Minor1
Conflicting Flow All	0	0	101
Stage 1	-	-	-
Stage 2	-	-	-
Critical Hdwy	-	-	4.12
Critical Hdwy Stg 1	-	-	-
Critical Hdwy Stg 2	-	-	-
Follow-up Hdwy	-	-	2.218
Pot Cap-1 Maneuver	-	-	1491
Stage 1	-	-	-
Stage 2	-	-	-
Platoon blocked, %	-	-	-
Mov Cap-1 Maneuver	-	-	1491
Mov Cap-2 Maneuver	-	-	-
Stage 1	-	-	-
Stage 2	-	-	-

Approach	EB	WB	NE
HCM Control Delay, s	0	4.1	9.6
HCM LOS			A

Minor Lane/Major Mvmt	NELn1	NELn2	EBT	EBR	WBL	WBT
Capacity (veh/h)	493	956	-	-	1491	-
HCM Lane V/C Ratio	0.024	0.123	-	-	0.107	-
HCM Control Delay (s)	12.5	9.3	-	-	7.7	-
HCM Lane LOS	B	A	-	-	A	-
HCM 95th %tile Q(veh)	0.1	0.4	-	-	0.4	-

HCM 6th TWSC
4: Eastlake Boulevard & Salt Drive

Total Traffic Conditions
AM Peak Hour - Year 2044

Intersection						
Int Delay, s/veh	0.4					
Movement	NWL	NWR	NET	NER	SWL	SWT
Lane Configurations						
Traffic Vol, veh/h	6	5	113	0	3	147
Future Vol, veh/h	6	5	113	0	3	147
Conflicting Peds, #/hr	0	0	0	0	0	0
Sign Control	Stop	Stop	Free	Free	Free	Free
RT Channelized	-	None	-	None	-	None
Storage Length	0	-	-	-	-	-
Veh in Median Storage, #	0	-	0	-	-	0
Grade, %	0	-	0	-	-	0
Peak Hour Factor	92	92	92	92	92	92
Heavy Vehicles, %	2	2	2	2	2	2
Mvmt Flow	7	5	123	0	3	160

Major/Minor	Minor1	Major1	Major2			
Conflicting Flow All	289	123	0	0	123	0
Stage 1	123	-	-	-	-	-
Stage 2	166	-	-	-	-	-
Critical Hdwy	6.42	6.22	-	-	4.12	-
Critical Hdwy Stg 1	5.42	-	-	-	-	-
Critical Hdwy Stg 2	5.42	-	-	-	-	-
Follow-up Hdwy	3.518	3.318	-	-	2.218	-
Pot Cap-1 Maneuver	702	928	-	-	1464	-
Stage 1	902	-	-	-	-	-
Stage 2	863	-	-	-	-	-
Platoon blocked, %			-	-		-
Mov Cap-1 Maneuver	701	928	-	-	1464	-
Mov Cap-2 Maneuver	721	-	-	-	-	-
Stage 1	902	-	-	-	-	-
Stage 2	861	-	-	-	-	-

Approach	NW	NE	SW
HCM Control Delay, s	9.6	0	0.1
HCM LOS	A		

Minor Lane/Major Mvmt	NET	NERNWLn1	SWL	SWT
Capacity (veh/h)	-	-	802	1464
HCM Lane V/C Ratio	-	-	0.015	0.002
HCM Control Delay (s)	-	-	9.6	7.5
HCM Lane LOS	-	-	A	A
HCM 95th %tile Q(veh)	-	-	0	0

HCM 6th TWSC
5: Eastlake Boulevard & Huron Road

Total Traffic Conditions
AM Peak Hour - Year 2044

Intersection						
Int Delay, s/veh	0.7					
Movement	WBL	WBR	NET	NER	SWL	SWT
Lane Configurations	↔		↔		↔	↔
Traffic Vol, veh/h	11	9	104	8	2	152
Future Vol, veh/h	11	9	104	8	2	152
Conflicting Peds, #/hr	0	0	0	0	0	0
Sign Control	Stop	Stop	Free	Free	Free	Free
RT Channelized	-	None	-	None	-	None
Storage Length	0	-	-	-	200	-
Veh in Median Storage, #	0	-	0	-	-	0
Grade, %	0	-	0	-	-	0
Peak Hour Factor	92	92	92	92	92	92
Heavy Vehicles, %	2	2	2	2	2	2
Mvmt Flow	12	10	113	9	2	165

Major/Minor	Minor1	Major1	Major2			
Conflicting Flow All	287	118	0	0	122	0
Stage 1	118	-	-	-	-	-
Stage 2	169	-	-	-	-	-
Critical Hdwy	6.42	6.22	-	-	4.12	-
Critical Hdwy Stg 1	5.42	-	-	-	-	-
Critical Hdwy Stg 2	5.42	-	-	-	-	-
Follow-up Hdwy	3.518	3.318	-	-	2.218	-
Pot Cap-1 Maneuver	703	934	-	-	1465	-
Stage 1	907	-	-	-	-	-
Stage 2	861	-	-	-	-	-
Platoon blocked, %			-	-	-	-
Mov Cap-1 Maneuver	702	934	-	-	1465	-
Mov Cap-2 Maneuver	702	-	-	-	-	-
Stage 1	907	-	-	-	-	-
Stage 2	860	-	-	-	-	-

Approach	WB	NE	SW
HCM Control Delay, s	9.7	0	0.1
HCM LOS	A		

Minor Lane/Major Mvmt	NET	NERWBLn1	SWL	SWT
Capacity (veh/h)	-	-	790	1465
HCM Lane V/C Ratio	-	-	0.028	0.001
HCM Control Delay (s)	-	-	9.7	7.5
HCM Lane LOS	-	-	A	A
HCM 95th %tile Q(veh)	-	-	0.1	0

HCM 6th TWSC
6: Eastlake Boulevard & Erie Road

Total Traffic Conditions
AM Peak Hour - Year 2044

Intersection						
Int Delay, s/veh	0.5					
Movement	NWL	NWR	NET	NER	SWL	SWT
Lane Configurations	↙↘		↔		↙	↘
Traffic Vol, veh/h	8	5	107	5	2	161
Future Vol, veh/h	8	5	107	5	2	161
Conflicting Peds, #/hr	0	0	0	0	0	0
Sign Control	Stop	Stop	Free	Free	Free	Free
RT Channelized	-	None	-	None	-	None
Storage Length	0	-	-	-	180	-
Veh in Median Storage, #	0	-	0	-	-	0
Grade, %	0	-	0	-	-	0
Peak Hour Factor	92	92	92	92	92	92
Heavy Vehicles, %	2	2	2	2	2	2
Mvmt Flow	9	5	116	5	2	175

Major/Minor	Minor1	Major1	Major2		
Conflicting Flow All	298	119	0	0	121
Stage 1	119	-	-	-	-
Stage 2	179	-	-	-	-
Critical Hdwy	6.42	6.22	-	-	4.12
Critical Hdwy Stg 1	5.42	-	-	-	-
Critical Hdwy Stg 2	5.42	-	-	-	-
Follow-up Hdwy	3.518	3.318	-	-	2.218
Pot Cap-1 Maneuver	693	933	-	-	1467
Stage 1	906	-	-	-	-
Stage 2	852	-	-	-	-
Platoon blocked, %			-	-	-
Mov Cap-1 Maneuver	692	933	-	-	1467
Mov Cap-2 Maneuver	715	-	-	-	-
Stage 1	906	-	-	-	-
Stage 2	851	-	-	-	-

Approach	NW	NE	SW
HCM Control Delay, s	9.7	0	0.1
HCM LOS	A		

Minor Lane/Major Mvmt	NET	NERNWLn1	SWL	SWT
Capacity (veh/h)	-	-	786	1467
HCM Lane V/C Ratio	-	-	0.018	0.001
HCM Control Delay (s)	-	-	9.7	7.5
HCM Lane LOS	-	-	A	A
HCM 95th %tile Q(veh)	-	-	0.1	0

HCM 6th TWSC
7: Manitoba Drive/Access A & Eastlake Boulevard

Total Traffic Conditions
AM Peak Hour - Year 2044

Intersection												
Int Delay, s/veh	3											
Movement	EBL	EBT	EBR	WBL	WBT	WBR	NBL	NBT	NBR	SBL	SBT	SBR
Lane Configurations	↖	↗		↖	↗			↕			↕	
Traffic Vol, veh/h	49	107	35	2	150	17	48	0	2	3	0	27
Future Vol, veh/h	49	107	35	2	150	17	48	0	2	3	0	27
Conflicting Peds, #/hr	0	0	0	0	0	0	0	0	0	0	0	0
Sign Control	Free	Free	Free	Free	Free	Free	Stop	Stop	Stop	Stop	Stop	Stop
RT Channelized	-	-	None	-	-	None	-	-	None	-	-	None
Storage Length	105	-	-	170	-	-	-	-	-	-	-	-
Veh in Median Storage, #	-	0	-	-	0	-	-	0	-	-	0	-
Grade, %	-	0	-	-	0	-	-	0	-	-	0	-
Peak Hour Factor	92	92	92	92	92	92	92	92	92	92	92	92
Heavy Vehicles, %	2	2	2	2	2	2	2	2	2	2	2	2
Mvmt Flow	53	116	38	2	163	18	52	0	2	3	0	29

Major/Minor	Major1			Major2			Minor1			Minor2		
Conflicting Flow All	181	0	0	154	0	0	432	426	135	418	436	172
Stage 1	-	-	-	-	-	-	241	241	-	176	176	-
Stage 2	-	-	-	-	-	-	191	185	-	242	260	-
Critical Hdwy	4.12	-	-	4.12	-	-	7.12	6.52	6.22	7.12	6.52	6.22
Critical Hdwy Stg 1	-	-	-	-	-	-	6.12	5.52	-	6.12	5.52	-
Critical Hdwy Stg 2	-	-	-	-	-	-	6.12	5.52	-	6.12	5.52	-
Follow-up Hdwy	2.218	-	-	2.218	-	-	3.518	4.018	3.318	3.518	4.018	3.318
Pot Cap-1 Maneuver	1394	-	-	1426	-	-	534	520	914	545	514	872
Stage 1	-	-	-	-	-	-	762	706	-	826	753	-
Stage 2	-	-	-	-	-	-	811	747	-	762	693	-
Platoon blocked, %	-	-	-	-	-	-	-	-	-	-	-	-
Mov Cap-1 Maneuver	1394	-	-	1426	-	-	500	500	914	528	494	872
Mov Cap-2 Maneuver	-	-	-	-	-	-	500	500	-	528	494	-
Stage 1	-	-	-	-	-	-	733	679	-	795	752	-
Stage 2	-	-	-	-	-	-	783	746	-	731	667	-

Approach	EB			WB			NB			SB		
HCM Control Delay, s	2			0.1			12.9			9.6		
HCM LOS							B			A		

Minor Lane/Major Mvmt	NBLn1	EBL	EBT	EBR	WBL	WBT	WBR	SBLn1
Capacity (veh/h)	509	1394	-	-	1426	-	-	819
HCM Lane V/C Ratio	0.107	0.038	-	-	0.002	-	-	0.04
HCM Control Delay (s)	12.9	7.7	-	-	7.5	-	-	9.6
HCM Lane LOS	B	A	-	-	A	-	-	A
HCM 95th %tile Q(veh)	0.4	0.1	-	-	0	-	-	0.1

HCM 6th TWSC
8: S Union Boulevard & Access B

Total Traffic Conditions
AM Peak Hour - Year 2044

Intersection						
Int Delay, s/veh	0.6					
Movement	WBL	WBR	NBT	NBR	SBL	SBT
Lane Configurations	↘↗		↑↓		↘	↑↑
Traffic Vol, veh/h	21	21	1230	21	21	779
Future Vol, veh/h	21	21	1230	21	21	779
Conflicting Peds, #/hr	0	0	0	0	0	0
Sign Control	Stop	Stop	Free	Free	Free	Free
RT Channelized	-	None	-	None	-	None
Storage Length	0	-	-	-	150	-
Veh in Median Storage, #	0	-	0	-	-	0
Grade, %	0	-	0	-	-	0
Peak Hour Factor	92	92	92	92	92	92
Heavy Vehicles, %	2	2	2	2	2	2
Mvmt Flow	23	23	1337	23	23	847

Major/Minor	Minor1	Major1	Major2		
Conflicting Flow All	1819	680	0	0	1360
Stage 1	1349	-	-	-	-
Stage 2	470	-	-	-	-
Critical Hdwy	6.84	6.94	-	-	4.14
Critical Hdwy Stg 1	5.84	-	-	-	-
Critical Hdwy Stg 2	5.84	-	-	-	-
Follow-up Hdwy	3.52	3.32	-	-	2.22
Pot Cap-1 Maneuver	69	393	-	-	501
Stage 1	206	-	-	-	-
Stage 2	595	-	-	-	-
Platoon blocked, %			-	-	-
Mov Cap-1 Maneuver	66	393	-	-	501
Mov Cap-2 Maneuver	160	-	-	-	-
Stage 1	206	-	-	-	-
Stage 2	568	-	-	-	-

Approach	WB	NB	SB
HCM Control Delay, s	24.8	0	0.3
HCM LOS	C		

Minor Lane/Major Mvmt	NBT	NBRWBLn1	SBL	SBT
Capacity (veh/h)	-	-	227	501
HCM Lane V/C Ratio	-	-	0.201	0.046
HCM Control Delay (s)	-	-	24.8	12.5
HCM Lane LOS	-	-	C	B
HCM 95th %tile Q(veh)	-	-	0.7	0.1

HCM 6th TWSC
9: Access C & Airport Road

Total Traffic Conditions
AM Peak Hour - Year 2044

Intersection						
Int Delay, s/veh	0.2					
Movement	EBT	EBR	WBL	WBT	NBL	NBR
Lane Configurations	↔			↑		↗
Traffic Vol, veh/h	99	16	0	155	0	5
Future Vol, veh/h	99	16	0	155	0	5
Conflicting Peds, #/hr	0	0	0	0	0	0
Sign Control	Free	Free	Free	Free	Stop	Stop
RT Channelized	-	None	-	None	-	None
Storage Length	-	-	-	-	-	0
Veh in Median Storage, #	0	-	-	0	0	-
Grade, %	0	-	-	0	0	-
Peak Hour Factor	92	92	92	92	92	92
Heavy Vehicles, %	2	2	2	2	2	2
Mvmt Flow	108	17	0	168	0	5

Major/Minor	Major1	Major2	Minor1			
Conflicting Flow All	0	0	-	-	-	117
Stage 1	-	-	-	-	-	-
Stage 2	-	-	-	-	-	-
Critical Hdwy	-	-	-	-	-	6.22
Critical Hdwy Stg 1	-	-	-	-	-	-
Critical Hdwy Stg 2	-	-	-	-	-	-
Follow-up Hdwy	-	-	-	-	-	3.318
Pot Cap-1 Maneuver	-	-	0	-	0	935
Stage 1	-	-	0	-	0	-
Stage 2	-	-	0	-	0	-
Platoon blocked, %	-	-	-	-	-	-
Mov Cap-1 Maneuver	-	-	-	-	-	935
Mov Cap-2 Maneuver	-	-	-	-	-	-
Stage 1	-	-	-	-	-	-
Stage 2	-	-	-	-	-	-

Approach	EB	WB	NB
HCM Control Delay, s	0	0	8.9
HCM LOS			A

Minor Lane/Major Mvmt	NBLn1	EBT	EBR	WBT
Capacity (veh/h)	935	-	-	-
HCM Lane V/C Ratio	0.006	-	-	-
HCM Control Delay (s)	8.9	-	-	-
HCM Lane LOS	A	-	-	-
HCM 95th %tile Q(veh)	0	-	-	-

HCM 6th TWSC
10: Access D & Airport Road

Total Traffic Conditions
AM Peak Hour - Year 2044

Intersection						
Int Delay, s/veh	0.8					
Movement	EBT	EBR	WBL	WBT	NBL	NBR
Lane Configurations						
Traffic Vol, veh/h	94	10	6	139	16	0
Future Vol, veh/h	94	10	6	139	16	0
Conflicting Peds, #/hr	0	0	0	0	0	0
Sign Control	Free	Free	Free	Free	Stop	Stop
RT Channelized	-	None	-	None	-	None
Storage Length	-	-	150	-	0	-
Veh in Median Storage, #	0	-	-	0	0	-
Grade, %	0	-	-	0	0	-
Peak Hour Factor	92	92	92	92	92	92
Heavy Vehicles, %	2	2	2	2	2	2
Mvmt Flow	102	11	7	151	17	0

Major/Minor	Major1	Major2	Minor1		
Conflicting Flow All	0	0	113	0	273 108
Stage 1	-	-	-	-	108 -
Stage 2	-	-	-	-	165 -
Critical Hdwy	-	-	4.12	-	6.42 6.22
Critical Hdwy Stg 1	-	-	-	-	5.42 -
Critical Hdwy Stg 2	-	-	-	-	5.42 -
Follow-up Hdwy	-	-	2.218	-	3.518 3.318
Pot Cap-1 Maneuver	-	-	1476	-	716 946
Stage 1	-	-	-	-	916 -
Stage 2	-	-	-	-	864 -
Platoon blocked, %	-	-	-	-	-
Mov Cap-1 Maneuver	-	-	1476	-	712 946
Mov Cap-2 Maneuver	-	-	-	-	728 -
Stage 1	-	-	-	-	916 -
Stage 2	-	-	-	-	860 -

Approach	EB	WB	NB
HCM Control Delay, s	0	0.3	10.1
HCM LOS			B

Minor Lane/Major Mvmt	NBLn1	EBT	EBR	WBL	WBT
Capacity (veh/h)	728	-	-	1476	-
HCM Lane V/C Ratio	0.024	-	-	0.004	-
HCM Control Delay (s)	10.1	-	-	7.5	-
HCM Lane LOS	B	-	-	A	-
HCM 95th %tile Q(veh)	0.1	-	-	0	-

HCM 6th TWSC
11: Access E & Airport Road

Total Traffic Conditions
AM Peak Hour - Year 2044

Intersection						
Int Delay, s/veh	0.8					
Movement	EBT	EBR	WBL	WBT	NBL	NBR
Lane Configurations	↗		↖	↑	↘	
Traffic Vol, veh/h	94	0	5	134	11	5
Future Vol, veh/h	94	0	5	134	11	5
Conflicting Peds, #/hr	0	0	0	0	0	0
Sign Control	Free	Free	Free	Free	Stop	Stop
RT Channelized	-	None	-	None	-	None
Storage Length	-	-	150	-	0	-
Veh in Median Storage, #	0	-	-	0	0	-
Grade, %	0	-	-	0	0	-
Peak Hour Factor	92	92	92	92	92	92
Heavy Vehicles, %	2	2	2	2	2	2
Mvmt Flow	102	0	5	146	12	5

Major/Minor	Major1	Major2	Minor1		
Conflicting Flow All	0	0	102	0	258
Stage 1	-	-	-	-	102
Stage 2	-	-	-	-	156
Critical Hdwy	-	-	4.12	-	6.42
Critical Hdwy Stg 1	-	-	-	-	5.42
Critical Hdwy Stg 2	-	-	-	-	5.42
Follow-up Hdwy	-	-	2.218	-	3.518
Pot Cap-1 Maneuver	-	-	1490	-	731
Stage 1	-	-	-	-	922
Stage 2	-	-	-	-	872
Platoon blocked, %	-	-	-	-	-
Mov Cap-1 Maneuver	-	-	1490	-	729
Mov Cap-2 Maneuver	-	-	-	-	739
Stage 1	-	-	-	-	922
Stage 2	-	-	-	-	869

Approach	EB	WB	NB
HCM Control Delay, s	0	0.3	9.6
HCM LOS			A

Minor Lane/Major Mvmt	NBLn1	EBT	EBR	WBL	WBT
Capacity (veh/h)	795	-	-	1490	-
HCM Lane V/C Ratio	0.022	-	-	0.004	-
HCM Control Delay (s)	9.6	-	-	7.4	-
HCM Lane LOS	A	-	-	A	-
HCM 95th %tile Q(veh)	0.1	-	-	0	-

HCM 6th TWSC
12: Eastlake Boulevard & Access F

Total Traffic Conditions
AM Peak Hour - Year 2044

Intersection						
Int Delay, s/veh	0.4					
Movement	EBL	EBT	WBT	WBR	SBL	SBR
Lane Configurations		↑	↑			↑
Traffic Vol, veh/h	0	173	225	0	0	16
Future Vol, veh/h	0	173	225	0	0	16
Conflicting Peds, #/hr	0	0	0	0	0	0
Sign Control	Free	Free	Free	Free	Stop	Stop
RT Channelized	-	None	-	None	-	None
Storage Length	-	-	-	-	-	0
Veh in Median Storage, #	-	0	0	-	0	-
Grade, %	-	0	0	-	0	-
Peak Hour Factor	92	92	92	92	92	92
Heavy Vehicles, %	2	2	2	2	2	2
Mvmt Flow	0	188	245	0	0	17

























Major/Minor	Major1	Major2	Minor2		
Conflicting Flow All	-	0	-	0	245
Stage 1	-	-	-	-	-
Stage 2	-	-	-	-	-
Critical Hdwy	-	-	-	-	6.22
Critical Hdwy Stg 1	-	-	-	-	-
Critical Hdwy Stg 2	-	-	-	-	-
Follow-up Hdwy	-	-	-	-	3.318
Pot Cap-1 Maneuver	0	-	-	-	794
Stage 1	0	-	-	-	-
Stage 2	0	-	-	-	-
Platoon blocked, %	-	-	-	-	-
Mov Cap-1 Maneuver	-	-	-	-	794
Mov Cap-2 Maneuver	-	-	-	-	-
Stage 1	-	-	-	-	-
Stage 2	-	-	-	-	-

Approach	EB	WB	SB
HCM Control Delay, s	0	0	9.6
HCM LOS			A

Minor Lane/Major Mvmt	EBT	WBT	WBR	SBLn1
Capacity (veh/h)	-	-	-	794
HCM Lane V/C Ratio	-	-	-	0.022
HCM Control Delay (s)	-	-	-	9.6
HCM Lane LOS	-	-	-	A
HCM 95th %tile Q(veh)	-	-	-	0.1

Timings
1: S Union Boulevard & Eastlake Boulevard

Total Traffic Conditions
PM Peak Hour - Year 2044





												
Lane Group	EBL	EBT	EBR	WBL	WBT	WBR	NBL	NBT	NBR	SBL	SBT	SBR
Lane Configurations												
Traffic Volume (vph)	81	119	26	93	88	20	15	905	58	48	1137	80
Future Volume (vph)	81	119	26	93	88	20	15	905	58	48	1137	80
Satd. Flow (prot)	1770	1863	1583	1770	1863	1583	1770	3507	0	1770	3539	1583
Flt Permitted	0.695			0.674			0.197			0.254		
Satd. Flow (perm)	1295	1863	1583	1255	1863	1583	367	3507	0	473	3539	1583
Satd. Flow (RTOR)			45			45		22				55
Lane Group Flow (vph)	88	129	28	101	96	22	16	1047	0	52	1236	87
Turn Type	Perm	NA	Perm	Perm	NA	Perm	Perm	NA		Perm	NA	Perm
Protected Phases		4			8			2				6
Permitted Phases	4		4	8		8	2			6		6
Detector Phase	4	4	4	8	8	8	2	2		6	6	6
Switch Phase												
Minimum Initial (s)	4.0	4.0	4.0	4.0	4.0	4.0	4.0	4.0		4.0	4.0	4.0
Minimum Split (s)	10.0	10.0	10.0	10.0	10.0	10.0	9.5	9.5		9.5	9.5	9.5
Total Split (s)	16.0	16.0	16.0	16.0	16.0	16.0	44.0	44.0		44.0	44.0	44.0
Total Split (%)	26.7%	26.7%	26.7%	26.7%	26.7%	26.7%	73.3%	73.3%		73.3%	73.3%	73.3%
Yellow Time (s)	4.0	4.0	4.0	4.0	4.0	4.0	3.5	3.5		3.5	3.5	3.5
All-Red Time (s)	2.0	2.0	2.0	2.0	2.0	2.0	2.0	2.0		2.0	2.0	2.0
Lost Time Adjust (s)	0.0	0.0	0.0	0.0	0.0	0.0	0.0	0.0		0.0	0.0	0.0
Total Lost Time (s)	6.0	6.0	6.0	6.0	6.0	6.0	5.5	5.5		5.5	5.5	5.5
Lead/Lag												
Lead-Lag Optimize?												
Recall Mode	None	None	None	None	None	None	C-Max	C-Max		C-Max	C-Max	C-Max
Act Effct Green (s)	8.8	8.8	8.8	8.7	8.7	8.7	43.2	43.2		43.2	43.2	43.2
Actuated g/C Ratio	0.15	0.15	0.15	0.14	0.14	0.14	0.72	0.72		0.72	0.72	0.72
v/c Ratio	0.46	0.47	0.10	0.55	0.35	0.08	0.06	0.41		0.15	0.49	0.08
Control Delay	31.4	29.0	6.0	35.4	26.3	4.3	4.8	5.2		5.7	5.9	2.2
Queue Delay	0.0	0.0	0.0	0.0	0.0	0.0	0.0	0.0		0.0	0.0	0.0
Total Delay	31.4	29.0	6.0	35.4	26.3	4.3	4.8	5.2		5.7	5.9	2.2
LOS	C	C	A	D	C	A	A	A		A	A	A
Approach Delay		27.2			28.3			5.2				5.6
Approach LOS		C			C			A				A
Queue Length 50th (ft)	29	42	0	34	31	0	2	82		6	107	4
Queue Length 95th (ft)	67	87	13	75	68	9	8	116		19	150	15
Internal Link Dist (ft)		416			59			351				235
Turn Bay Length (ft)	65		60	40		40	100			125		30
Base Capacity (vph)	215	310	301	209	310	301	264	2529		340	2545	1154
Starvation Cap Reductn	0	0	0	0	0	0	0	0		0	0	0
Spillback Cap Reductn	0	0	0	0	0	0	0	0		0	0	0
Storage Cap Reductn	0	0	0	0	0	0	0	0		0	0	0
Reduced v/c Ratio	0.41	0.42	0.09	0.48	0.31	0.07	0.06	0.41		0.15	0.49	0.08
Intersection Summary												
Cycle Length: 60												
Actuated Cycle Length: 60												
Offset: 0 (0%), Referenced to phase 2:NBT and 6:SBT, Start of Green												
Natural Cycle: 40												
Control Type: Actuated-Coordinated												

Timings
 1: S Union Boulevard & Eastlake Boulevard

Total Traffic Conditions
 PM Peak Hour - Year 2044

Maximum v/c Ratio: 0.55	
Intersection Signal Delay: 9.0	Intersection LOS: A
Intersection Capacity Utilization 60.7%	ICU Level of Service B
Analysis Period (min) 15	

Splits and Phases: 1: S Union Boulevard & Eastlake Boulevard

 Ø2 (R) 44 s	 Ø4 16 s
 Ø6 (R) 44 s	 Ø8 16 s

HCM 6th TWSC
2: S Union Boulevard & Airport Road

Total Traffic Conditions
PM Peak Hour - Year 2044

Intersection						
Int Delay, s/veh	1.3					
Movement	WBL	WBR	NBT	NBR	SBL	SBT
Lane Configurations	↘	↗	↑↑	↗	↘	↑↑
Traffic Vol, veh/h	39	91	969	36	128	1208
Future Vol, veh/h	39	91	969	36	128	1208
Conflicting Peds, #/hr	0	0	0	0	0	0
Sign Control	Stop	Stop	Free	Free	Free	Free
RT Channelized	-	None	-	None	-	None
Storage Length	0	70	-	60	350	-
Veh in Median Storage, #	0	-	0	-	-	0
Grade, %	0	-	0	-	-	0
Peak Hour Factor	92	92	92	92	92	92
Heavy Vehicles, %	2	2	2	2	2	2
Mvmt Flow	42	99	1053	39	139	1313

Major/Minor	Minor1	Major1	Major2		
Conflicting Flow All	1988	527	0	0	1092
Stage 1	1053	-	-	-	-
Stage 2	935	-	-	-	-
Critical Hdwy	6.84	6.94	-	-	4.14
Critical Hdwy Stg 1	5.84	-	-	-	-
Critical Hdwy Stg 2	5.84	-	-	-	-
Follow-up Hdwy	3.52	3.32	-	-	2.22
Pot Cap-1 Maneuver	79	*711	-	-	984
Stage 1	645	-	-	-	-
Stage 2	342	-	-	-	-
Platoon blocked, %	1	1	-	-	1
Mov Cap-1 Maneuver	68	*711	-	-	984
Mov Cap-2 Maneuver	210	-	-	-	-
Stage 1	645	-	-	-	-
Stage 2	294	-	-	-	-

Approach	WB	NB	SB
HCM Control Delay, s	15.6	0	0.9
HCM LOS	C		

Minor Lane/Major Mvmt	NBT	NBR	WBLn1	WBLn2	SBL	SBT
Capacity (veh/h)	-	-	210	711	984	-
HCM Lane V/C Ratio	-	-	0.202	0.139	0.141	-
HCM Control Delay (s)	-	-	26.4	10.9	9.3	-
HCM Lane LOS	-	-	D	B	A	-
HCM 95th %tile Q(veh)	-	-	0.7	0.5	0.5	-

Notes
 ~: Volume exceeds capacity \$: Delay exceeds 300s +: Computation Not Defined *: All major volume in platoon

HCM 6th TWSC
3: Eastlake Boulevard & Airport Road

Total Traffic Conditions
PM Peak Hour - Year 2044

Intersection						
Int Delay, s/veh	4.8					
Movement	EBT	EBR	WBL	WBT	NEL	NER
Lane Configurations	↶		↷	↶	↷	↷
Traffic Vol, veh/h	136	17	147	120	6	159
Future Vol, veh/h	136	17	147	120	6	159
Conflicting Peds, #/hr	0	0	0	0	0	0
Sign Control	Free	Free	Free	Free	Stop	Stop
RT Channelized	-	None	-	None	-	None
Storage Length	-	-	400	-	80	-
Veh in Median Storage, #	0	-	-	0	0	-
Grade, %	0	-	-	0	0	-
Peak Hour Factor	92	92	92	92	92	92
Heavy Vehicles, %	2	2	2	2	2	2
Mvmt Flow	148	18	160	130	7	173

Major/Minor	Major1	Major2	Minor1		
Conflicting Flow All	0	0	166	0	607 157
Stage 1	-	-	-	-	157 -
Stage 2	-	-	-	-	450 -
Critical Hdwy	-	-	4.12	-	6.42 6.22
Critical Hdwy Stg 1	-	-	-	-	5.42 -
Critical Hdwy Stg 2	-	-	-	-	5.42 -
Follow-up Hdwy	-	-	2.218	-	3.518 3.318
Pot Cap-1 Maneuver	-	-	1412	-	460 889
Stage 1	-	-	-	-	871 -
Stage 2	-	-	-	-	642 -
Platoon blocked, %	-	-	-	-	-
Mov Cap-1 Maneuver	-	-	1412	-	408 889
Mov Cap-2 Maneuver	-	-	-	-	481 -
Stage 1	-	-	-	-	871 -
Stage 2	-	-	-	-	569 -

Approach	EB	WB	NE
HCM Control Delay, s	0	4.3	10.1
HCM LOS			B

Minor Lane/Major Mvmt	NELn1	NELn2	EBT	EBR	WBL	WBT
Capacity (veh/h)	481	889	-	-	1412	-
HCM Lane V/C Ratio	0.014	0.194	-	-	0.113	-
HCM Control Delay (s)	12.6	10	-	-	7.9	-
HCM Lane LOS	B	B	-	-	A	-
HCM 95th %tile Q(veh)	0	0.7	-	-	0.4	-

HCM 6th TWSC
4: Eastlake Boulevard & Salt Drive

Total Traffic Conditions
PM Peak Hour - Year 2044

Intersection						
Int Delay, s/veh	0.4					
Movement	NWL	NWR	NET	NER	SWL	SWT
Lane Configurations	↘↗		↕			↖↗
Traffic Vol, veh/h	6	5	156	5	3	161
Future Vol, veh/h	6	5	156	5	3	161
Conflicting Peds, #/hr	0	0	0	0	0	0
Sign Control	Stop	Stop	Free	Free	Free	Free
RT Channelized	-	None	-	None	-	None
Storage Length	0	-	-	-	-	-
Veh in Median Storage, #	0	-	0	-	-	0
Grade, %	0	-	0	-	-	0
Peak Hour Factor	92	92	92	92	92	92
Heavy Vehicles, %	2	2	2	2	2	2
Mvmt Flow	7	5	170	5	3	175

Major/Minor	Minor1	Major1	Major2			
Conflicting Flow All	354	173	0	0	175	0
Stage 1	173	-	-	-	-	-
Stage 2	181	-	-	-	-	-
Critical Hdwy	6.42	6.22	-	-	4.12	-
Critical Hdwy Stg 1	5.42	-	-	-	-	-
Critical Hdwy Stg 2	5.42	-	-	-	-	-
Follow-up Hdwy	3.518	3.318	-	-	2.218	-
Pot Cap-1 Maneuver	644	871	-	-	1401	-
Stage 1	857	-	-	-	-	-
Stage 2	850	-	-	-	-	-
Platoon blocked, %			-	-	-	-
Mov Cap-1 Maneuver	643	871	-	-	1401	-
Mov Cap-2 Maneuver	682	-	-	-	-	-
Stage 1	857	-	-	-	-	-
Stage 2	848	-	-	-	-	-

Approach	NW	NE	SW
HCM Control Delay, s	9.8	0	0.1
HCM LOS	A		

Minor Lane/Major Mvmt	NET	NERNWLn1	SWL	SWT
Capacity (veh/h)	-	-	757	1401
HCM Lane V/C Ratio	-	-	0.016	0.002
HCM Control Delay (s)	-	-	9.8	7.6
HCM Lane LOS	-	-	A	A
HCM 95th %tile Q(veh)	-	-	0	0

HCM 6th TWSC
5: Eastlake Boulevard & Huron Road

Total Traffic Conditions
PM Peak Hour - Year 2044

Intersection						
Int Delay, s/veh	0.5					
Movement	WBL	WBR	NET	NER	SWL	SWT
Lane Configurations	↘↗		↖↗		↘↗	↖↗
Traffic Vol, veh/h	6	2	159	14	11	156
Future Vol, veh/h	6	2	159	14	11	156
Conflicting Peds, #/hr	0	0	0	0	0	0
Sign Control	Stop	Stop	Free	Free	Free	Free
RT Channelized	-	None	-	None	-	None
Storage Length	0	-	-	-	200	-
Veh in Median Storage, #	0	-	0	-	-	0
Grade, %	0	-	0	-	-	0
Peak Hour Factor	92	92	92	92	92	92
Heavy Vehicles, %	2	2	2	2	2	2
Mvmt Flow	7	2	173	15	12	170

Major/Minor	Minor1	Major1	Major2		
Conflicting Flow All	375	181	0	0	188
Stage 1	181	-	-	-	-
Stage 2	194	-	-	-	-
Critical Hdwy	6.42	6.22	-	-	4.12
Critical Hdwy Stg 1	5.42	-	-	-	-
Critical Hdwy Stg 2	5.42	-	-	-	-
Follow-up Hdwy	3.518	3.318	-	-	2.218
Pot Cap-1 Maneuver	626	862	-	-	1386
Stage 1	850	-	-	-	-
Stage 2	839	-	-	-	-
Platoon blocked, %			-	-	-
Mov Cap-1 Maneuver	620	862	-	-	1386
Mov Cap-2 Maneuver	620	-	-	-	-
Stage 1	850	-	-	-	-
Stage 2	831	-	-	-	-

Approach	WB	NE	SW
HCM Control Delay, s	10.5	0	0.5
HCM LOS	B		

Minor Lane/Major Mvmt	NET	NERWBLn1	SWL	SWT
Capacity (veh/h)	-	-	667	1386
HCM Lane V/C Ratio	-	-	0.013	0.009
HCM Control Delay (s)	-	-	10.5	7.6
HCM Lane LOS	-	-	B	A
HCM 95th %tile Q(veh)	-	-	0	0

HCM 6th TWSC
6: Eastlake Boulevard & Erie Road

Total Traffic Conditions
PM Peak Hour - Year 2044

Intersection						
Int Delay, s/veh	0.3					
Movement	NWL	NWR	NET	NER	SWL	SWT
Lane Configurations	↔		↔		↔	↔
Traffic Vol, veh/h	6	3	170	11	3	159
Future Vol, veh/h	6	3	170	11	3	159
Conflicting Peds, #/hr	0	0	0	0	0	0
Sign Control	Stop	Stop	Free	Free	Free	Free
RT Channelized	-	None	-	None	-	None
Storage Length	0	-	-	-	180	-
Veh in Median Storage, #	0	-	0	-	-	0
Grade, %	0	-	0	-	-	0
Peak Hour Factor	92	92	92	92	92	92
Heavy Vehicles, %	2	2	2	2	2	2
Mvmt Flow	7	3	185	12	3	173

Major/Minor	Minor1	Major1	Major2		
Conflicting Flow All	370	191	0	0	197
Stage 1	191	-	-	-	-
Stage 2	179	-	-	-	-
Critical Hdwy	6.42	6.22	-	-	4.12
Critical Hdwy Stg 1	5.42	-	-	-	-
Critical Hdwy Stg 2	5.42	-	-	-	-
Follow-up Hdwy	3.518	3.318	-	-	2.218
Pot Cap-1 Maneuver	630	851	-	-	1376
Stage 1	841	-	-	-	-
Stage 2	852	-	-	-	-
Platoon blocked, %			-	-	-
Mov Cap-1 Maneuver	629	851	-	-	1376
Mov Cap-2 Maneuver	673	-	-	-	-
Stage 1	841	-	-	-	-
Stage 2	850	-	-	-	-

Approach	NW	NE	SW
HCM Control Delay, s	10	0	0.1
HCM LOS	B		

Minor Lane/Major Mvmt	NET	NER	NWLn1	SWL	SWT
Capacity (veh/h)	-	-	723	1376	-
HCM Lane V/C Ratio	-	-	0.014	0.002	-
HCM Control Delay (s)	-	-	10	7.6	-
HCM Lane LOS	-	-	B	A	-
HCM 95th %tile Q(veh)	-	-	0	0	-

HCM 6th TWSC
7: Manitoba Drive/Access A & Eastlake Boulevard

Total Traffic Conditions
PM Peak Hour - Year 2044

Intersection												
Int Delay, s/veh	1.8											
Movement	EBL	EBT	EBR	WBL	WBT	WBR	NBL	NBT	NBR	SBL	SBT	SBR
Lane Configurations	↖	↗		↖	↗			↕			↕	
Traffic Vol, veh/h	27	167	32	3	158	5	15	0	3	11	0	22
Future Vol, veh/h	27	167	32	3	158	5	15	0	3	11	0	22
Conflicting Peds, #/hr	0	0	0	0	0	0	0	0	0	0	0	0
Sign Control	Free	Free	Free	Free	Free	Free	Stop	Stop	Stop	Stop	Stop	Stop
RT Channelized	-	-	None	-	-	None	-	-	None	-	-	None
Storage Length	105	-	-	170	-	-	-	-	-	-	-	-
Veh in Median Storage, #	-	0	-	-	0	-	-	0	-	-	0	-
Grade, %	-	0	-	-	0	-	-	0	-	-	0	-
Peak Hour Factor	92	92	92	92	92	92	92	92	92	92	92	92
Heavy Vehicles, %	2	2	2	2	2	2	2	2	2	2	2	2
Mvmt Flow	29	182	35	3	172	5	16	0	3	12	0	24

Major/Minor	Major1			Major2			Minor1			Minor2		
Conflicting Flow All	177	0	0	217	0	0	451	441	200	440	456	175
Stage 1	-	-	-	-	-	-	258	258	-	181	181	-
Stage 2	-	-	-	-	-	-	193	183	-	259	275	-
Critical Hdwy	4.12	-	-	4.12	-	-	7.12	6.52	6.22	7.12	6.52	6.22
Critical Hdwy Stg 1	-	-	-	-	-	-	6.12	5.52	-	6.12	5.52	-
Critical Hdwy Stg 2	-	-	-	-	-	-	6.12	5.52	-	6.12	5.52	-
Follow-up Hdwy	2.218	-	-	2.218	-	-	3.518	4.018	3.318	3.518	4.018	3.318
Pot Cap-1 Maneuver	1399	-	-	1353	-	-	519	510	841	527	501	868
Stage 1	-	-	-	-	-	-	747	694	-	821	750	-
Stage 2	-	-	-	-	-	-	809	748	-	746	683	-
Platoon blocked, %	-	-	-	-	-	-	-	-	-	-	-	-
Mov Cap-1 Maneuver	1399	-	-	1353	-	-	496	498	841	516	489	868
Mov Cap-2 Maneuver	-	-	-	-	-	-	496	498	-	516	489	-
Stage 1	-	-	-	-	-	-	731	679	-	804	749	-
Stage 2	-	-	-	-	-	-	785	747	-	728	669	-

Approach	EB			WB			NB			SB		
HCM Control Delay, s	0.9			0.1			12			10.4		
HCM LOS							B			B		

Minor Lane/Major Mvmt	NBLn1	EBL	EBT	EBR	WBL	WBT	WBR	SBLn1
Capacity (veh/h)	532	1399	-	-	1353	-	-	707
HCM Lane V/C Ratio	0.037	0.021	-	-	0.002	-	-	0.051
HCM Control Delay (s)	12	7.6	-	-	7.7	-	-	10.4
HCM Lane LOS	B	A	-	-	A	-	-	B
HCM 95th %tile Q(veh)	0.1	0.1	-	-	0	-	-	0.2

HCM 6th TWSC
8: S Union Boulevard & Access B

Total Traffic Conditions
PM Peak Hour - Year 2044

Intersection						
Int Delay, s/veh	0.4					
Movement	WBL	WBR	NBT	NBR	SBL	SBT
Lane Configurations	↘↗		↑↑		↘	↑↑
Traffic Vol, veh/h	16	15	985	21	21	1226
Future Vol, veh/h	16	15	985	21	21	1226
Conflicting Peds, #/hr	0	0	0	0	0	0
Sign Control	Stop	Stop	Free	Free	Free	Free
RT Channelized	-	None	-	None	-	None
Storage Length	0	-	-	-	150	-
Veh in Median Storage, #	0	-	0	-	-	0
Grade, %	0	-	0	-	-	0
Peak Hour Factor	92	92	92	92	92	92
Heavy Vehicles, %	2	2	2	2	2	2
Mvmt Flow	17	16	1071	23	23	1333

Major/Minor	Minor1	Major1	Major2		
Conflicting Flow All	1796	547	0	0	1094
Stage 1	1083	-	-	-	-
Stage 2	713	-	-	-	-
Critical Hdwy	6.84	6.94	-	-	4.14
Critical Hdwy Stg 1	5.84	-	-	-	-
Critical Hdwy Stg 2	5.84	-	-	-	-
Follow-up Hdwy	3.52	3.32	-	-	2.22
Pot Cap-1 Maneuver	72	481	-	-	634
Stage 1	286	-	-	-	-
Stage 2	447	-	-	-	-
Platoon blocked, %			-	-	-
Mov Cap-1 Maneuver	69	481	-	-	634
Mov Cap-2 Maneuver	187	-	-	-	-
Stage 1	286	-	-	-	-
Stage 2	431	-	-	-	-

Approach	WB	NB	SB
HCM Control Delay, s	20.5	0	0.2
HCM LOS	C		

Minor Lane/Major Mvmt	NBT	NBRWBLn1	SBL	SBT
Capacity (veh/h)	-	-	266	634
HCM Lane V/C Ratio	-	-	0.127	0.036
HCM Control Delay (s)	-	-	20.5	10.9
HCM Lane LOS	-	-	C	B
HCM 95th %tile Q(veh)	-	-	0.4	0.1

HCM 6th TWSC
9: Access C & Airport Road

Total Traffic Conditions
PM Peak Hour - Year 2044

Intersection						
Int Delay, s/veh	0.1					
Movement	EBT	EBR	WBL	WBT	NBL	NBR
Lane Configurations	↔			↑		↗
Traffic Vol, veh/h	148	16	0	136	0	4
Future Vol, veh/h	148	16	0	136	0	4
Conflicting Peds, #/hr	0	0	0	0	0	0
Sign Control	Free	Free	Free	Free	Stop	Stop
RT Channelized	-	None	-	None	-	None
Storage Length	-	-	-	-	-	0
Veh in Median Storage, #	0	-	-	0	0	-
Grade, %	0	-	-	0	0	-
Peak Hour Factor	92	92	92	92	92	92
Heavy Vehicles, %	2	2	2	2	2	2
Mvmt Flow	161	17	0	148	0	4

Major/Minor	Major1	Major2	Minor1			
Conflicting Flow All	0	0	-	-	-	170
Stage 1	-	-	-	-	-	-
Stage 2	-	-	-	-	-	-
Critical Hdwy	-	-	-	-	-	6.22
Critical Hdwy Stg 1	-	-	-	-	-	-
Critical Hdwy Stg 2	-	-	-	-	-	-
Follow-up Hdwy	-	-	-	-	-	3.318
Pot Cap-1 Maneuver	-	-	0	-	0	874
Stage 1	-	-	0	-	0	-
Stage 2	-	-	0	-	0	-
Platoon blocked, %	-	-	-	-	-	-
Mov Cap-1 Maneuver	-	-	-	-	-	874
Mov Cap-2 Maneuver	-	-	-	-	-	-
Stage 1	-	-	-	-	-	-
Stage 2	-	-	-	-	-	-

Approach	EB	WB	NB
HCM Control Delay, s	0	0	9.1
HCM LOS			A

Minor Lane/Major Mvmt	NBLn1	EBT	EBR	WBT
Capacity (veh/h)	874	-	-	-
HCM Lane V/C Ratio	0.005	-	-	-
HCM Control Delay (s)	9.1	-	-	-
HCM Lane LOS	A	-	-	-
HCM 95th %tile Q(veh)	0	-	-	-

HCM 6th TWSC
10: Access D & Airport Road

Total Traffic Conditions
PM Peak Hour - Year 2044

Intersection						
Int Delay, s/veh	0.5					
Movement	EBT	EBR	WBL	WBT	NBL	NBR
Lane Configurations	↶		↷	↶	↷	
Traffic Vol, veh/h	142	10	5	124	12	0
Future Vol, veh/h	142	10	5	124	12	0
Conflicting Peds, #/hr	0	0	0	0	0	0
Sign Control	Free	Free	Free	Free	Stop	Stop
RT Channelized	-	None	-	None	-	None
Storage Length	-	-	150	-	0	-
Veh in Median Storage, #	0	-	-	0	0	-
Grade, %	0	-	-	0	0	-
Peak Hour Factor	92	92	92	92	92	92
Heavy Vehicles, %	2	2	2	2	2	2
Mvmt Flow	154	11	5	135	13	0

Major/Minor	Major1	Major2	Minor1		
Conflicting Flow All	0	0	165	0	305
Stage 1	-	-	-	-	160
Stage 2	-	-	-	-	145
Critical Hdwy	-	-	4.12	-	6.42
Critical Hdwy Stg 1	-	-	-	-	5.42
Critical Hdwy Stg 2	-	-	-	-	5.42
Follow-up Hdwy	-	-	2.218	-	3.518
Pot Cap-1 Maneuver	-	-	1413	-	687
Stage 1	-	-	-	-	869
Stage 2	-	-	-	-	882
Platoon blocked, %	-	-	-	-	-
Mov Cap-1 Maneuver	-	-	1413	-	684
Mov Cap-2 Maneuver	-	-	-	-	711
Stage 1	-	-	-	-	869
Stage 2	-	-	-	-	878

Approach	EB	WB	NB
HCM Control Delay, s	0	0.3	10.2
HCM LOS			B

Minor Lane/Major Mvmt	NBLn1	EBT	EBR	WBL	WBT
Capacity (veh/h)	711	-	-	1413	-
HCM Lane V/C Ratio	0.018	-	-	0.004	-
HCM Control Delay (s)	10.2	-	-	7.6	-
HCM Lane LOS	B	-	-	A	-
HCM 95th %tile Q(veh)	0.1	-	-	0	-

HCM 6th TWSC
11: Access E & Airport Road

Total Traffic Conditions
PM Peak Hour - Year 2044

Intersection						
Int Delay, s/veh	0.6					
Movement	EBT	EBR	WBL	WBT	NBL	NBR
Lane Configurations						
Traffic Vol, veh/h	142	0	5	121	8	4
Future Vol, veh/h	142	0	5	121	8	4
Conflicting Peds, #/hr	0	0	0	0	0	0
Sign Control	Free	Free	Free	Free	Stop	Stop
RT Channelized	-	None	-	None	-	None
Storage Length	-	-	150	-	0	-
Veh in Median Storage, #	0	-	-	0	0	-
Grade, %	0	-	-	0	0	-
Peak Hour Factor	92	92	92	92	92	92
Heavy Vehicles, %	2	2	2	2	2	2
Mvmt Flow	154	0	5	132	9	4

Major/Minor	Major1	Major2	Minor1	Minor2	Minor3
Conflicting Flow All	0	0	154	0	296
Stage 1	-	-	-	-	154
Stage 2	-	-	-	-	142
Critical Hdwy	-	-	4.12	-	6.42
Critical Hdwy Stg 1	-	-	-	-	5.42
Critical Hdwy Stg 2	-	-	-	-	5.42
Follow-up Hdwy	-	-	2.218	-	3.518
Pot Cap-1 Maneuver	-	-	1426	-	695
Stage 1	-	-	-	-	874
Stage 2	-	-	-	-	885
Platoon blocked, %	-	-	-	-	-
Mov Cap-1 Maneuver	-	-	1426	-	692
Mov Cap-2 Maneuver	-	-	-	-	716
Stage 1	-	-	-	-	874
Stage 2	-	-	-	-	881

Approach	EB	WB	NB
HCM Control Delay, s	0	0.3	9.8
HCM LOS			A

Minor Lane/Major Mvmt	NBLn1	EBT	EBR	WBL	WBT
Capacity (veh/h)	766	-	-	1426	-
HCM Lane V/C Ratio	0.017	-	-	0.004	-
HCM Control Delay (s)	9.8	-	-	7.5	-
HCM Lane LOS	A	-	-	A	-
HCM 95th %tile Q(veh)	0.1	-	-	0	-

HCM 6th TWSC
 12: Eastlake Boulevard & Access F

Total Traffic Conditions
 PM Peak Hour - Year 2044

Intersection						
Int Delay, s/veh	0.3					
Movement	EBL	EBT	WBT	WBR	SBL	SBR
Lane Configurations		↑	↑			↑
Traffic Vol, veh/h	0	202	195	0	0	12
Future Vol, veh/h	0	202	195	0	0	12
Conflicting Peds, #/hr	0	0	0	0	0	0
Sign Control	Free	Free	Free	Free	Stop	Stop
RT Channelized	-	None	-	None	-	None
Storage Length	-	-	-	-	-	0
Veh in Median Storage, #	-	0	0	-	0	-
Grade, %	-	0	0	-	0	-
Peak Hour Factor	92	92	92	92	92	92
Heavy Vehicles, %	2	2	2	2	2	2
Mvmt Flow	0	220	212	0	0	13

Major/Minor	Major1	Major2	Minor2
Conflicting Flow All	-	0	-
Stage 1	-	-	-
Stage 2	-	-	-
Critical Hdwy	-	-	-
Critical Hdwy Stg 1	-	-	-
Critical Hdwy Stg 2	-	-	-
Follow-up Hdwy	-	-	-
Pot Cap-1 Maneuver	0	-	-
Stage 1	0	-	-
Stage 2	0	-	-
Platoon blocked, %	-	-	-
Mov Cap-1 Maneuver	-	-	-
Mov Cap-2 Maneuver	-	-	-
Stage 1	-	-	-
Stage 2	-	-	-

Approach	EB	WB	SB
HCM Control Delay, s	0	0	9.4
HCM LOS			A

Minor Lane/Major Mvmt	EBT	WBT	WBR	SBLn1
Capacity (veh/h)	-	-	-	828
HCM Lane V/C Ratio	-	-	-	0.016
HCM Control Delay (s)	-	-	-	9.4
HCM Lane LOS	-	-	-	A
HCM 95th %tile Q(veh)	-	-	-	0