



September 13, 2022

Mr. Adam Wallace
Morgan Group, Inc.
201 Fillmore Street
Suite 201
Denver, Colorado 80206

Re: Spectrum and Voyager
Traffic Statement Letter
Colorado Springs, Colorado

Dear Mr. Wallace,

This letter documents the changes associated to the previously accepted Spectrum and Voyager Traffic Impact Study completed by Kimley-Horn and Associates dated May 5, 2022. The recently amended Spectrum and Voyager Traffic Impact Study was completed by Kimley-Horn and Associates dated September 12, 2022. The Spectrum and Voyager residential project is proposed to be located on the southeast corner of the Voyager Parkway and North Spectrum Loop intersection in Colorado Springs, Colorado. The purpose of the updated traffic study was to address concerns from the public and members of Planning Commission.

With all the additional tasks and methodologies within the updated traffic study, the conclusions and recommendations remain the same as the previous traffic study with exception of providing options for the existing west access to remain with full turning movements or to be restricted to right-in/right-out movements as decided by the project team and staff at the City of Colorado Springs. The conceptual improvement exhibits for the side-by-side left turn lanes (west access remaining full movement) and raised center median along Spectrum Loop adjacent to the west access (west access restricted to right-in/right-out movements) are located in Appendix G of the revised traffic study. The following provides key items that were changed or included in the revised Spectrum and Voyager traffic study and the associated result or summary for each item:

1. Planning Commission had concerns with the residential unit density of the project.
 - The number of units in the project has decreased. The original traffic impact study was prepared to evaluate a development with 443 dwelling units. The revised traffic study evaluated a project with the now proposed 355 dwelling units.
2. The list of intersections for study was expanded to evaluate three additional key intersections of Powers Boulevard Westbound On Ramp/Voyager Parkway, Powers Boulevard Eastbound Off Ramp/Voyager Parkway, and South Spectrum Loop/Voyager Parkway
 - These three additional intersections were evaluated. Each of these additional intersections are expected to operate acceptably with the existing lane configurations and control throughout the 2045 horizon with the addition of Spectrum and Voyager project traffic.
3. The time period of the traffic counts was expanded with additional data collected from 2:00 PM to 4:00 PM at the seven (7) study area key intersections to align with the peak traffic volumes identified from the Street Light traffic data provided from the

- City of Colorado Springs. This is in addition to the industry standard weekday peak hours of 7:00 AM to 9:00 AM and 4:00 PM to 6:00 PM.
- It was determined that peak hour traffic volumes for four of the seven studied intersections occurred during the expanded time period (2:00 PM to 4:00 PM) and not the typical peak hours of 4:00 PM to 6:00 PM. The slightly higher volumes during this time period for these four intersections were conservatively utilized in the revised analysis and did not result in any additional improvement recommendations.
4. Additional evaluation was provided for the west project access along North Spectrum Loop being restricted to right-in/right-out movements as an alternative analysis.
 - The proposed west access along North Spectrum Loop is expected to operate acceptably under both access scenarios including full turning movements or to be restricted to right-in/right-out movements. Vehicle queues are calculated to be contained in the turn lanes for the full movement side-by-side left turn scenario in 2025 but fall short by approximately 25 feet in 2045 (previously fell short by 175 feet without improvements).
 5. Provided two conceptual improvement exhibits at the North Spectrum Loop/Voyager Parkway intersection and west project access intersection including a side-by-side left turn lane configuration and restricting the west access to right-in/right-out movements.
 - Conceptual improvement exhibits for the side-by-side left turn lanes (west access remaining full movement) and raised center median along Spectrum Loop adjacent to the west access (west access restricted to right-in/right-out movements) are located in Appendix G of the revised traffic study.
 6. Included projected traffic volumes from three adjacent developments within the background traffic as identified from their traffic studies.
 - Traffic volumes generated from the proposed Amphitheater, the proposed Polaris Junction multifamily development, and the proposed Springs at Northgate multifamily development were added as background traffic and did not change the results of the traffic study.
 7. Collected weekday 14-hour traffic counts (6:00 AM to 8:00 PM) at the driveway access to the FalconView residential complex.
 - FalconView Apartments has the same ownership as the proposed project and includes the same type of residential uses as proposed with this development. FalconView is located approximately three miles south of the project within the City of Colorado Springs and is currently 98 percent occupied. From the counts collected, it was determined that the actual daily and morning peak driveway counts observed were lower than ITE Trip Generation Manual equations while the afternoon peak hour driveway counts were higher than ITE equations. Therefore, the trip rates from the afternoon driveway counts were conservatively used while the typical ITE equations were used for the daily and morning peak hour to provide a conservative analysis.
 8. Performed site visit to observe and report westbound left turn vehicle queues during the morning and afternoon peak hours (7:00 AM to 9:00 AM and 4:00 PM to 6:00 PM) at the North Spectrum Loop and Voyager Parkway intersection.
 - This is summarized thoroughly in Section 3.1 on pages 6 and 7 of the revised traffic study. A maximum of 10 vehicles were observed as being queued on

the westbound approach of the North Spectrum Loop and Voyager Parkway intersection during the peak hours. There were only two occasions when the vehicles did not all fully clear the green phase on this approach and one of these instances were due to driver distraction (would have cleared otherwise) and the other occurred with an eight (8) vehicle queue. It should be noted that nine (9) and 10 vehicle queues were observed clearing; therefore, eight (8) vehicles should clear if average driver perception and reaction times are experienced.

9. Provided additional supplemental traffic analysis for the project site being developed with office use with a modified trip distribution (for internal purposes only and not documented in the traffic study).
 - o With additional distribution to and from the east for a possible office use, the westbound left turn vehicle queues at the North Spectrum Loop and Voyager Parkway intersection are approximately 50 feet longer than the vehicles queues reported with the proposed residential use. Further, the intersection of North Gate Boulevard and Voyager Parkway was reported to operate at LOS E during the afternoon peak hour in 2045 with the possible office use while this intersection operates acceptably with LOS D during the afternoon peak hour in 2045 with the proposed residential project use. Lastly, there are not any additional improvements required for the residential use that would not be needed with the office use.

If you have any questions or require anything further, please feel free to call.

Sincerely,

KIMLEY-HORN AND ASSOCIATES, INC.



Jeffrey R. Planck, P.E.
Project Manager



K:\091_3770\18103201 - Spectrum and Voyager\Project\Deliverables\ExhibitA\Deliverables\18103201.dwg
The information contained herein is the property of Kimley-Horn and Associates, Inc. and is intended for the use of the client only. It is not to be distributed, copied, or used for any other purpose without the written consent of Kimley-Horn and Associates, Inc.



VOYAGER PARKWAY

SPECTRUM LOOP

4'
11'
11'



OPTION A: SIDE-BY-SIDE LEFT TURNS

EXHIBIT A

Kimley»Horn

© 2019 KIMLEY-HORN AND ASSOCIATES, INC.
4582 SOUTH ULSTER STREET, SUITE 1500, DENVER, CO 80237
PHONE: 303-228-2300

K:\08_1770\18102001 - Spectrum and Hyatt\Projects\18102001\18102001.dwg
The information contained on this drawing is the property of Kimley-Horn and Associates, Inc. and is to be used only for the project and site identified on this drawing. It is not to be used for any other project or site without the written consent of Kimley-Horn and Associates, Inc.

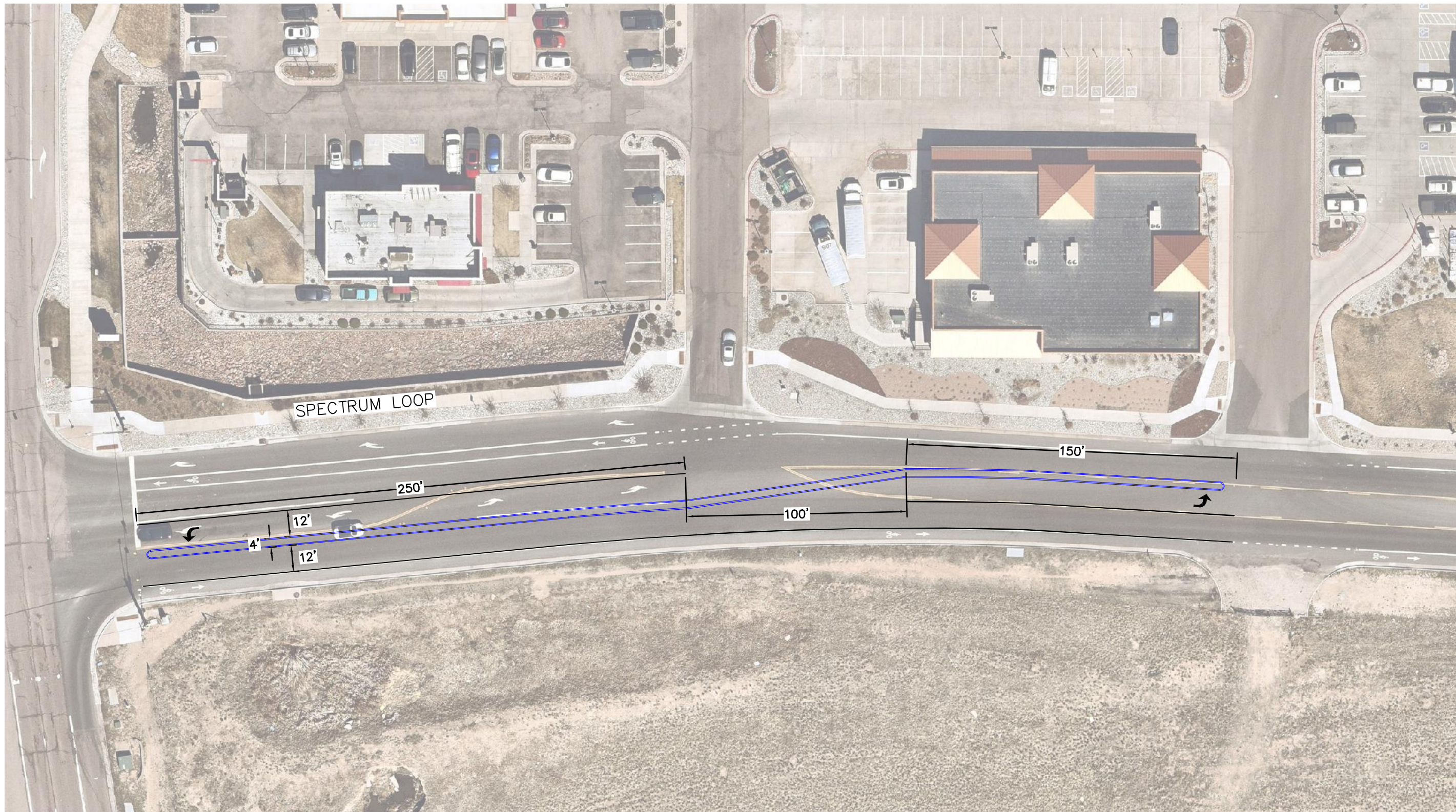

OPTION B: RESTRICTING ACCESS

EXHIBIT B

Kimley»Horn
© 2019 KIMLEY-HORN AND ASSOCIATES, INC.
4582 SOUTH ULSTER STREET, SUITE 1500, DENVER, CO 80237
PHONE: 303-228-2300

Traffic Impact Study

Spectrum and Voyager

Colorado Springs, Colorado

Prepared for:

Morgan Group, Inc.

Kimley»Horn

Spectrum and Voyager

Colorado Springs, Colorado

Prepared for
Morgan Group, Inc
201 Fillmore Street
Suite 201
Denver, Colorado 80206

Prepared by
Kimley-Horn and Associates, Inc.
2 North Nevada Avenue
Suite 300
Colorado Springs, Colorado 80903
(719) 453-0180



September 2022

This document, together with the concepts and designs presented herein, as an instrument of service, is intended only for the specific purpose and client for which it was prepared. Reuse of and improper reliance on this document without written authorization and adaptation by Kimley-Horn and Associates, Inc. shall be without liability to Kimley-Horn and Associates, Inc.

TABLE OF CONTENTS

TABLE OF CONTENTS	i
LIST OF TABLES	ii
LIST OF FIGURES	ii
1.0 EXECUTIVE SUMMARY	1
2.0 INTRODUCTION	4
3.0 EXISTING AND FUTURE CONDITIONS	6
3.1 Existing Study Area	6
3.2 Existing Roadway Network	7
3.3 Existing Traffic Volumes	16
3.4 Unspecified Development Traffic Growth	17
4.0 PROJECT TRAFFIC CHARACTERISTICS	21
4.1 Trip Generation	21
4.2 Trip Distribution	23
4.3 Traffic Assignment	24
4.4 Total (Background Plus Project) Traffic	24
5.0 TRAFFIC OPERATIONS ANALYSIS	29
5.1 Analysis Methodology	29
5.2 Key Intersection Operational Analysis	30
5.3 Vehicle Queuing Analysis	40
5.4 Improvement Summary	42
6.0 CONCLUSIONS AND RECOMMENDATIONS	45

APPENDICES

Appendix A – Intersection Count Sheets/Street Light Traffic Data

Appendix B – Future Traffic Projections/Background Studies

Appendix C – Trip Generation Worksheets

Appendix D – Intersection Analysis Worksheets

Appendix E – Signal Timings

Appendix F – Queue Analysis Worksheets

Appendix G – North Spectrum Loop West Access Exhibits

Appendix H – Conceptual Site Plan

LIST OF TABLES

Table 1 – Spectrum and Voyager Traffic Generation.....	22
Table 2 – Trip Generation Comparison: Existing Zoning vs. Proposed Zoning.....	23
Table 3 – Level of Service Definitions	29
Table 4 – North Gate Boulevard & Voyager Parkway (#1) LOS Results.....	30
Table 5 – North Gate Boulevard & Grey Hawk Drive (#2) LOS Results.....	32
Table 6 – North Spectrum Loop & Voyager Parkway (#3) LOS Results	33
Table 7 – North Spectrum Loop & Grey Hawk Drive (#4) LOS Results	34
Table 8 – Powers Boulevard On-Ramp & Voyager Parkway (#5) LOS Results.....	35
Table 9 – Powers Boulevard Off-Ramp & Voyager Parkway (#6) LOS Results.....	36
Table 10 – Powers Boulevard Off-Ramp & Voyager Parkway (#6) LOS Results.....	37
Table 11 – Project Access Level of Service Results.....	39
Table 12 – Turn Lane Queuing Analysis Results.....	40

LIST OF FIGURES

Figure 1 – Vicinity Map.....	5
Figure 2 – Existing Geometry and Control.....	15
Figure 3 – 2022 Existing Traffic Volumes.....	18
Figure 4 – 2024 Background Traffic Volumes.....	19
Figure 5 – 2045 Background Traffic Volumes.....	20
Figure 6 – Project Trip Distribution	25
Figure 7 – Project Traffic Assignment	26
Figure 8 – 2024 Total Traffic Volumes	27
Figure 9 – 2045 Total Traffic Volumes	28
Figure 10 – 2024 Recommended Geometry and Control	43
Figure 11 – 2045 Recommended Geometry and Control	44

1.0 EXECUTIVE SUMMARY

This report has been prepared to document the results of a Traffic Impact Study for the Spectrum and Voyager residential project proposed to be located on the southeast corner of the Voyager Parkway and North Spectrum Loop intersection in Colorado Springs, Colorado. For the purposes of this analysis, the maximum density scenario of approximately 355 multifamily housing units was included for evaluation in this study. It is expected that the Spectrum and Voyager project will be completed in the next couple of years; therefore, analysis was conducted for the 2024 short-term buildout horizon as well as the 2045 long-term twenty-year planning horizon.

The purpose of this traffic study is to identify project traffic generation characteristics to determine potential project traffic related impacts on the local street system and to develop the necessary mitigation measures required for the identified traffic impacts. The following intersections were incorporated into this traffic study in accordance with the City of Colorado Springs standards and requirements:

- North Gate Boulevard and Voyager Parkway (#1)
- North Gate Boulevard and Grey Hawk Drive (#2)
- North Spectrum Loop and Voyager Parkway (#3)
- North Spectrum Loop and Grey Hawk Drive (#4)
- Powers Boulevard On-Ramp and Voyager Parkway (#5)
- Powers Boulevard Off-Ramp and Voyager Parkway (#6)
- South Spectrum Loop and Voyager Parkway (#7)

In addition, the two proposed accesses along North Spectrum Loop were evaluated.

Regional access to Spectrum and Voyager will be provided by Interstate 25 (I-25) and State Highway 83 (SH-83). Primary access will be provided by North Gate Boulevard and Voyager Parkway. Direct access will be provided by two proposed accesses along the south side of North Spectrum Loop. The two project accesses are proposed to align with accesses to the retail center to the north. Of note, the SH-21 half interchange ramps with Voyager Parkway were recently constructed south of the project.

Spectrum and Voyager is expected to generate approximately 1,612 weekday daily trips, with 131 of these trips occurring during the morning peak hour and 174 of these trips occurring during the afternoon peak hour.

Based on the analysis presented in this report, Kimley-Horn believes the Spectrum and Voyager project will be successfully incorporated into the existing and future roadway network. Analysis of the existing street network, the proposed project development, and expected traffic volumes resulted in the following conclusions and recommendations:

2024 Recommendations:

- With completion of the Spectrum and Voyager project, two project accesses are proposed along the south side of North Spectrum Loop. The west access (#8) and the east access (#9) both will align with existing full movement accesses to the retail center to the north. It is recommended that a R1-1 “STOP” sign be installed on the exiting northbound approaches of both accesses. A single exiting lane for all movements should be sufficient at both accesses. The North Spectrum Loop East Access (#9) should operate as a full movement access. The North Spectrum Loop West Access (#8) could operate as a full movement access or a right-in/right-out access. With a full movement access at the North Spectrum Loop West Access (#9), the two-way left turn lane that is currently striped at both proposed accesses will provide left turn movements for entering the proposed development. If the North Spectrum Loop West Access (#9) were restricted to right-in/right-out movements due to long vehicle queues, a raised center median would be constructed along Spectrum Loop to restrict left turning movements at this access.
- It is recommended that the northbound and southbound left turn phasing at the intersection of North Spectrum Loop and Voyager Parkway (#3) be changed to protected-permissive in order to provide acceptable operations. It should be noted that the westbound left turn lane at the intersection of North Spectrum Loop and Voyager Parkway (#3) is anticipated to exceed the available storage. If the North Spectrum Loop West Access (#8) remains a full movement access, it is recommended that the westbound left turn lane at the intersection of North Spectrum Loop and Voyager Parkway (#3) be designated to a maximum length of 240 feet. This would require the eastbound left turn lane at the North Spectrum Loop West Access (#8) to be side by side with the westbound left turn lane at the intersection of North Spectrum Loop

and Voyager Parkway (#3) and designated to a length of 200 feet. If the North Spectrum Loop West Access (#8) were restricted to right turn movements only, it is recommended that the westbound left turn lane at the intersection of North Spectrum Loop and Voyager Parkway (#3) be designated to a maximum length of 250 feet with a 100-foot taper. This 100-foot taper would be shared with the eastbound left turn lane at the North Spectrum Loop East Access (#9) which would be designated to a maximum length of 150 feet. A conceptual improvement exhibit is attached in **Appendix G** for the side-by-side left turn lane configuration with the scenario of the west access remaining full turning movements. Likewise, a conceptual improvement exhibit is also attached in **Appendix G** with the scenario of the west access being a restricted to right-in/right-out movements. Of note, implementing protective-permissive left turn phasing on the westbound approach of the North Spectrum Loop and Voyager Parkway (#3) intersection could be considered to help reduce vehicle queues.

2045 Recommendations:

- By 2045, dual westbound left turn lanes may be needed at the intersection of North Gate Boulevard and Voyager Parkway (#1). The area for these dual left turn lanes is presently available and will only require restriping as the space for the second turn lane is currently striped out.

General Recommendations:

- Any on-site or offsite improvements should be incorporated into the Civil Drawings and conform to standards of the City of Colorado Springs and the Manual on Uniform Traffic Control Devices (MUTCD) – 2009 Edition.

2.0 INTRODUCTION

Kimley-Horn and Associates, Inc. has prepared this report to document the results of a Traffic Impact Study for the Spectrum and Voyager residential project proposed to be located on the southeast corner of the Voyager Parkway and North Spectrum Loop intersection in Colorado Springs, Colorado. A vicinity map illustrating the Spectrum and Voyager development location is shown in **Figure 1**. For the purposes of this analysis, the maximum density scenario of approximately 355 multifamily housing units was included for evaluation in this study. A conceptual site plan is attached in **Appendix H**. It is expected that Spectrum and Voyager will be completed in the next couple of years; therefore, analysis was conducted for the 2024 short-term buildout horizon as well as the 2045 long-term twenty-year planning horizon.

The purpose of this traffic study is to identify project traffic generation characteristics to determine potential project traffic related impacts on the local street system and to develop the necessary mitigation measures required for the identified traffic impacts. The following intersections were incorporated into this traffic study in accordance with the City of Colorado Springs standards and requirements:

- North Gate Boulevard and Voyager Parkway (#1)
- North Gate Boulevard and Grey Hawk Drive (#2)
- North Spectrum Loop and Voyager Parkway (#3)
- North Spectrum Loop and Grey Hawk Drive (#4)
- Powers Boulevard On-Ramp and Voyager Parkway (#5)
- Powers Boulevard Off-Ramp and Voyager Parkway (#6)
- South Spectrum Loop and Voyager Parkway (#7)

In addition, the two proposed accesses along North Spectrum Loop were evaluated.

Regional access to Spectrum and Voyager will be provided by Interstate 25 (I-25) and State Highway 83 (SH-83). Primary access will be provided by North Gate Boulevard and Voyager Parkway. Direct access will be provided by two proposed accesses along the south side of North Spectrum Loop. The two project accesses are proposed to align with accesses to the retail center to the north. Of note, the SH-21 half interchange ramps with Voyager Parkway were recently constructed south of the project.



SPECTRUM AND VOYAGER
COLORADO SPRINGS, COLORADO
VICINITY MAP

FIGURE 1

3.0 EXISTING AND FUTURE CONDITIONS

3.1 Existing Study Area

The existing site is comprised of vacant land. A gas station and commercial uses located to the south of the project. Directly north of the site is a shopping center with an urgent care. Single family residences are located to the east of the site. West of the project site is a small shopping center and more vacant land. An office development is located to the northwest of the project. The extended area to the east, north, and south include residential uses.

At the request of City of Colorado Springs staff and the public, queue length observations were done for the westbound left turn lane at the intersection of North Spectrum Loop and Voyager Parkway (#3). These observations were conducted during the morning and afternoon peak periods on Tuesday, August 30, 2022, from 7:00 to 9:00 AM and 4:00 to 6:00 PM. The existing westbound left turn can accommodate four (4) vehicles within the storage length and one (1) additional vehicle within the taper length. During the morning peak period, the maximum queue experienced was nine (9) vehicles which occurred twice, with eight (8) passenger cars and one (1) truck in the first case and seven (7) passenger cars and two (2) trucks the second time. In both cases, all vehicles within the queue were able to be cleared within the cycle. A tenth vehicle also arrived after several vehicles already cleared in the turn lane in the first occurrence of the nine (9) vehicle queue and this vehicle was also able to be cleared during the cycle. The average queue experienced during the morning peak hour was 3.6 vehicles with an average of 3.9 vehicles performing westbound left turning movements during the cycle (greater than the queue length as some vehicles arrived when the queue had already cleared but the signal remained green).

During the afternoon peak period, the maximum queue experienced was also nine (9) vehicles—all passenger cars—and occurred once. In two instances during the afternoon peak period, one (1) vehicle was unable to clear the westbound left turn in the same cycle. The first occurred due to driver distraction and would not have otherwise occurred, while the second occurred because of the eight (8) vehicle queue experienced (seven (7) passenger cars and one (1) truck). Of note, there were multiple instances where vehicles entering into the westbound left turn lane at this intersection traversed over the double-yellow striping and into the adjacent eastbound left turn lane that goes into the retail access. In one instance, because of an existing four (4) vehicle queue in the westbound left turn lane, a large truck also waiting to perform a westbound left turning

movement queued in the retail eastbound left turn lane, almost entirely blocking the eastbound left turn lane, and causing eastbound left turning vehicles to turn from the eastbound through lane instead. In addition, there were a few instances throughout the morning and afternoon peak periods where the westbound left turn queue blocked the west retail access. The average queue length experienced during the afternoon peak hour was approximately 5.4 vehicles with an average of 6.2 westbound left turning vehicles cleared during the cycle.

3.2 Existing Roadway Network

North Gate Boulevard extends in the east-west direction with two through lanes in each direction and a raised median. The posted speed limit near the site is 35 miles per hour. Voyager Parkway extends northbound and southbound with two through lanes in each direction and a raised median. The posted speed limit along Voyager Parkway near the site is 35 miles per hour. Grey Hawk Drive extends north-south with one through lane in each direction. North Spectrum Loop extends primarily eastbound and westbound direction with one through lane in each direction. South Spectrum Loop extends primarily eastbound and westbound with one through lane in each direction east of Voyager Parkway and two through lanes in each direction west of Voyager Parkway. South Spectrum Loop has a speed limit of 30 miles per hour.

The signalized intersection of North Gate Boulevard and Voyager Parkway (#1) operates with protected-permissive left turn phasing on the eastbound, westbound, and southbound approaches and protected-only left turn phasing on the northbound approach. The northbound approach provides dual left turn lanes, one through lane, and a right turn lane while the southbound approach provides a left turn lane, one through lane, and a right turn lane. The eastbound and westbound approaches provide a left turn lane, two through lanes, and a right turn lane. An aerial photo of the existing intersection configuration is below (north is up - typical).



North Gate Boulevard and Voyager Parkway (#1)

The unsignalized intersection of North Gate Boulevard and Grey Hawk Drive (#2) operates with stop control on the northbound and southbound Grey Hawk Drive approaches. The northbound and southbound approaches provide a shared left turn/through lane and a right turn lane. The eastbound and westbound approaches consist of a left turn lane, two through lanes, and a right turn lane. An aerial photo of the existing intersection configuration is below.



North Gate Boulevard and Grey Hawk Drive (#2)

The signalized intersection of North Spectrum Loop and Voyager Parkway (#3) operates with protected-only left turn phasing on the northbound and southbound approaches and permissive-only left turn phasing on the eastbound and westbound approaches. The northbound and southbound approaches provide a left turn lane, two through lanes, and a right turn lane. The eastbound and westbound approaches provide a left turn lane, one through lane, and a right turn lane. An aerial photo of the existing intersection configuration is below.



North Spectrum Loop and Voyager Parkway (#3)

The unsignalized 'T'-intersection of North Spectrum Loop and Grey Hawk Drive (#4) operates as a roundabout with yield control on the eastbound, westbound, and southbound approaches. The three approaches all provide a single lane for shared movements. An aerial photo of the existing intersection configuration is below.



North Spectrum Loop and Grey Hawk Drive (#4)

The signalized intersection of Powers Boulevard On-Ramp and Voyager Parkway (#5) operates with protected-only left turn phasing on the northbound approach. The northbound approach provides a left turn lane and two through lanes. The southbound approach consists of two through lanes and a free right turn lane. The west leg of this intersection provides two receiving lanes. An aerial photo of the existing intersection configuration is below.



Powers Boulevard On-Ramp and Voyager Parkway (#5)

The signalized intersection of Powers Boulevard Off-Ramp and Voyager Parkway (#6) operates with protected-only left turn phasing on the eastbound approach. The northbound approach provides three through lanes with the inside lane being designated for external stacking to the northbound left turn lane at the on-ramp intersection to the north. The southbound approach consists of two through lanes. The eastbound approach consists of dual left turn lanes and a right turn lane. An aerial photo of the existing intersection configuration is below.



Powers Boulevard Off-Ramp and Voyager Parkway (#6)

The signalized intersection of South Spectrum Loop/Cooper Center Parkway and Voyager Parkway (#7) operates with protected-only left turn phasing on the northbound and southbound Voyager Parkway approaches and permitted-only left turn phasing on the eastbound and westbound approaches. The northbound and southbound approaches of Voyager Parkway consist of one left turn lane, two through lanes, and a right turn lane. The eastbound South Spectrum Loop and westbound Copper Center Parkway approaches consist of one left turn lane, one through lane, and one right turn lane. An aerial photo of the existing intersection configuration is below.



South Spectrum Loop/Cooper Center Parkway and Voyager Parkway (#7)

The intersection lane configuration and control for the study area intersections are shown in **Figure 2**.

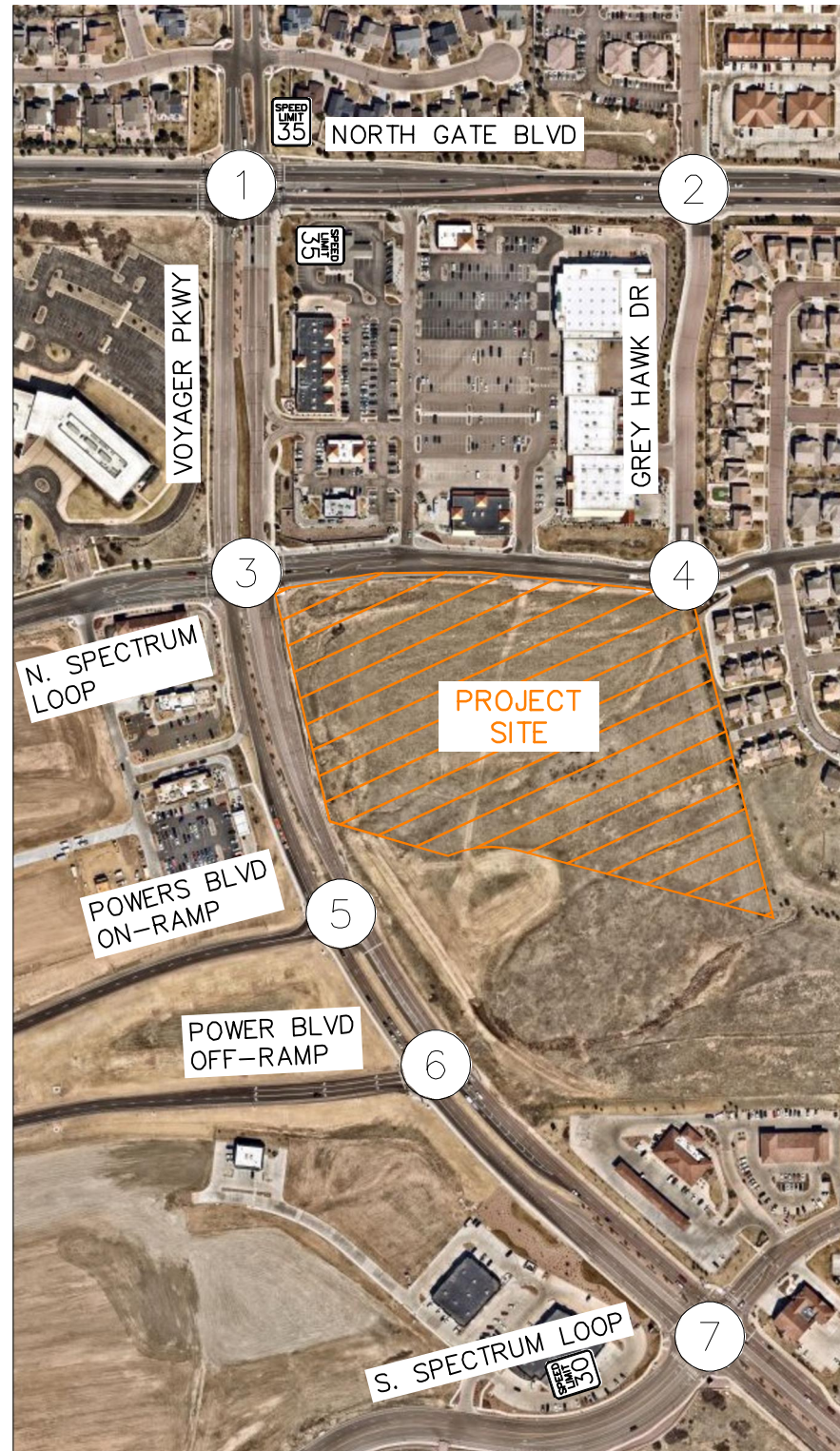

SPECTRUM AND VOYAGER
 COLORADO SPRINGS, COLORADO
 EXISTING GEOMETRY AND CONTROL

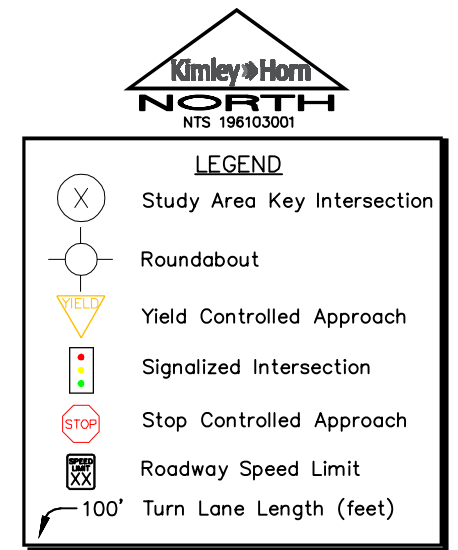
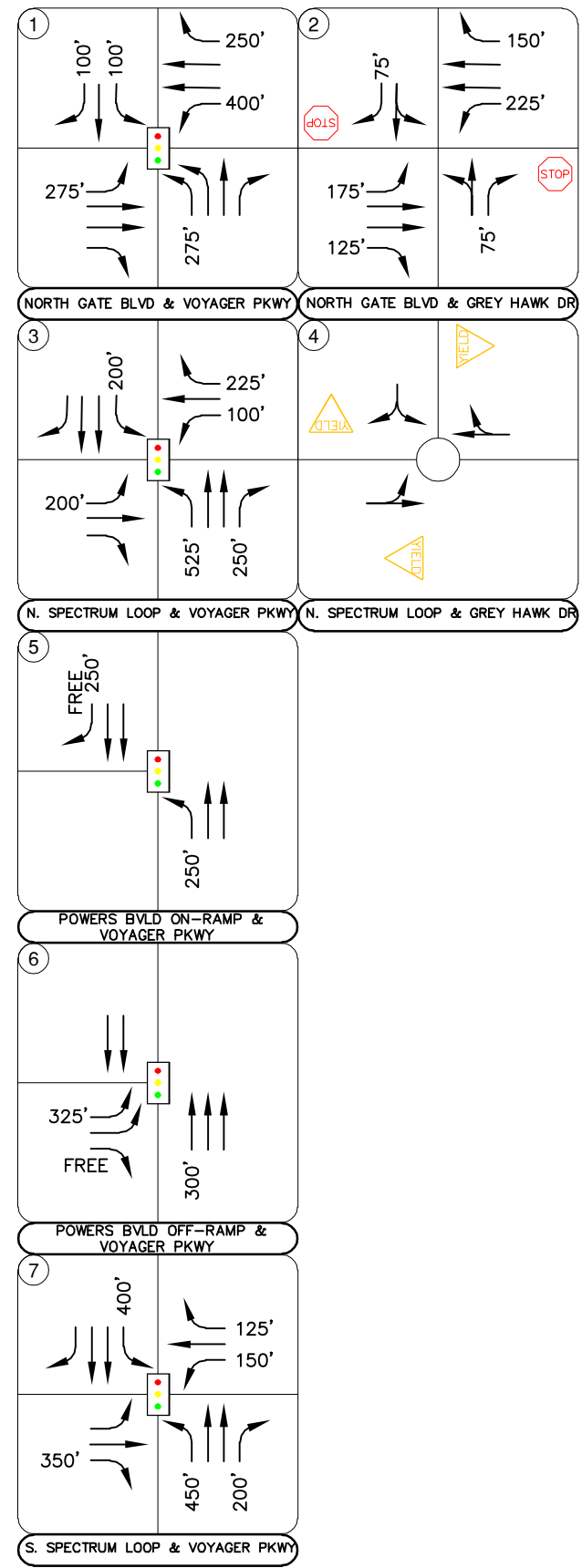

FIGURE 2

3.3 Existing Traffic Volumes

Existing turning movement counts were conducted at the study intersections as follows:

Wednesday, January 26, 2022 (7:00 AM to 9:00 AM/4:00 PM to 6:00 PM)

- North Gate Boulevard and Voyager Parkway (#1)
- North Gate Boulevard and Grey Hawk Drive (#2)
- North Spectrum Loop and Voyager Parkway (#3)
- North Spectrum Loop and Grey Hawk Drive (#4)

Thursday, August 25, 2022 (2:00 to 4:00 PM)

- North Gate Boulevard and Voyager Parkway (#1)
- North Gate Boulevard and Grey Hawk Drive (#2)
- North Spectrum Loop and Voyager Parkway (#3)
- North Spectrum Loop and Grey Hawk Drive (#4)
- Powers Boulevard On-Ramp and Voyager Parkway (#5)
- Powers Boulevard Off-Ramp and Voyager Parkway (#6)
- South Spectrum Loop and Voyager Parkway (#7)

Tuesday, April 26, 2022 (7:00 AM to 9:00 AM/4:00 PM to 6:00 PM)

- Powers Boulevard On-Ramp and Voyager Parkway (#5)
- Powers Boulevard Off-Ramp and Voyager Parkway (#6)
- South Spectrum Loop and Voyager Parkway (#7)

The counts were conducted during the morning and afternoon peak hours of adjacent street traffic in 15-minute intervals from 7:00 AM to 9:00 AM and 4:00 PM to 6:00 PM on these count dates. Additionally, based on Street Light Model Traffic Data provided by the City of Colorado Springs, the morning peak hour of adjacent street traffic occurs from 7:00 AM to 8:00 AM and the afternoon peak hour occurs from 2:45 to 3:45 PM at the intersection of North Spectrum Loop and Voyager Parkway (#3). Therefore, additional counts were taken at the key intersections from 2:00 PM to 4:00 PM on Tuesday, August 25, 2022. The existing intersection traffic volumes are shown in **Figure 3** with count sheets and Street Light traffic data provided in **Appendix A**.

3.4 Unspecified Development Traffic Growth

According to information provided on the website for the Colorado Department of Transportation (CDOT), the 20-year growth factor along SH-83 near the site is 1.78. The 20-year growth factor equates to an annual growth rate of 2.9 percent. Traffic information from the CDOT Online Transportation Information System (OTIS) website is included in **Appendix B**. Since the area surrounding the south leg of the North Gate Boulevard and Voyager Parkway intersection and the east leg of the North Spectrum Loop and Voyager Parkway intersection will be completely built out with development of the project, a conservative 0.5 percent annual growth rate was applied to these areas. These annual growth rates were used to estimate near term 2024 and long term 2045 traffic volume projections at the key intersections. Additionally, traffic from the proposed Amphitheater, the proposed Polaris Junction multifamily development, and the proposed Springs at Northgate multifamily development were added as background traffic. Documents for the three proposed background studies were included in **Appendix B**. Background traffic volumes for 2024 and 2045 are shown in **Figures 4** and **5**, respectively.

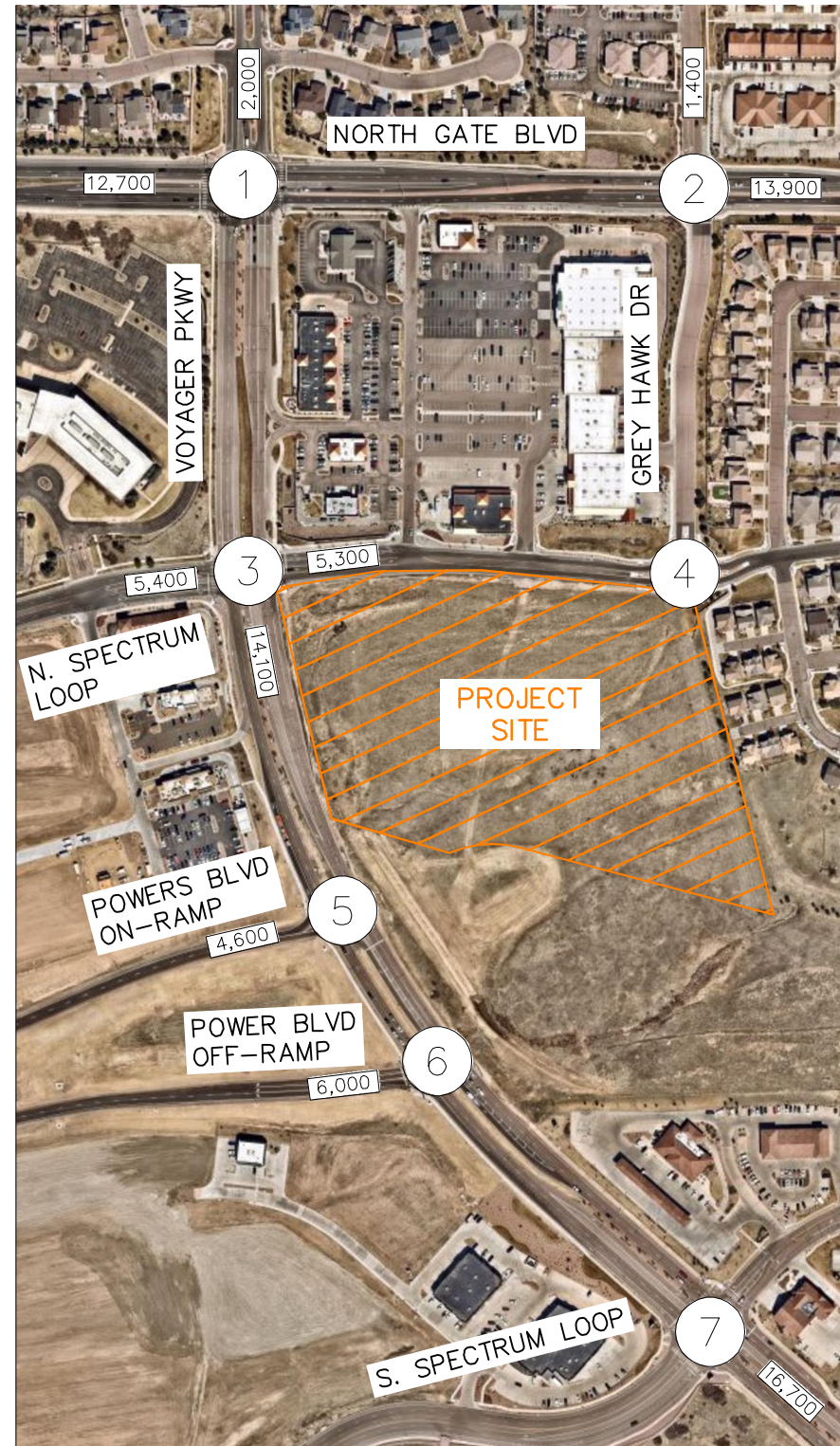

SPECTRUM AND VOYAGER
 COLORADO SPRINGS, COLORADO
 2022 EXISTING TRAFFIC VOLUMES

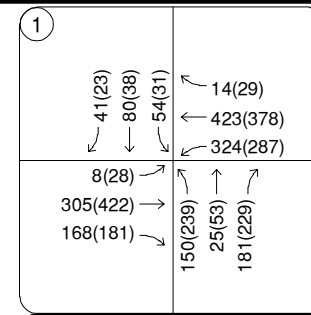

NORTH GATE BLVD & VOYAGER PKWY

Wednesday, January 26, 2022
 7:15 to 8:15AM
 Thursday, August 25, 2022
 3:00 to 4:00PM

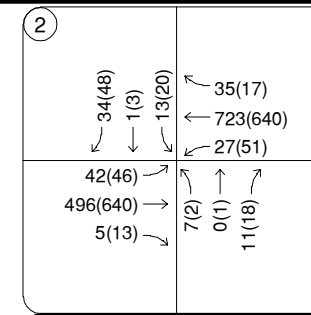

NORTH GATE BLVD & GREY HAWK DR

Wednesday, January 26, 2022
 7:15 to 8:15AM
 Thursday, August 25, 2022
 3:00 to 4:30PM

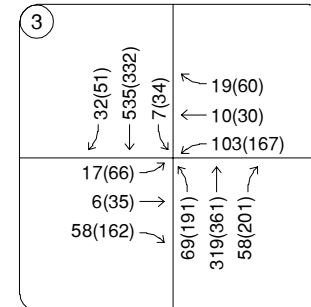

N. SPECTRUM LOOP & VOYAGER PKWY

Wednesday, January 26, 2022
 7:15 to 8:15AM
 Wednesday, January 26, 2022
 4:30 to 5:30PM

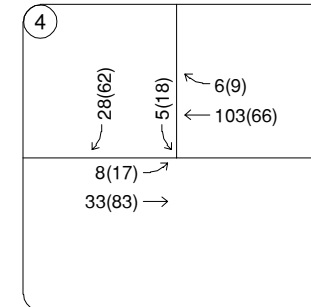

N. SPECTRUM LOOP & GREY HAWK DR

Wednesday, January 26, 2022
 7:30 to 8:30AM
 Wednesday, January 26, 2022
 4:30 to 5:30PM

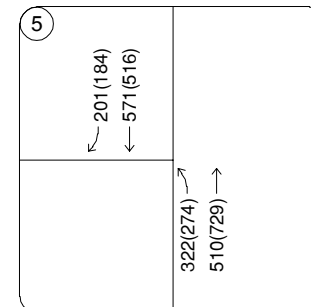

POWERS BLVD ON-RAMP & VOYAGER PKWY

Tuesday, April 26, 2022
 7:15 to 8:15AM
 Thursday, August 25, 2022
 3:00 to 4:00PM

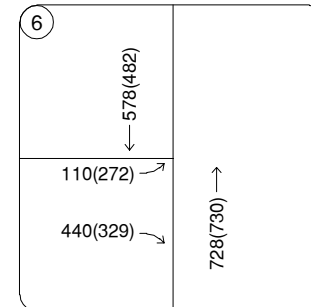

POWERS BLVD OFF-RAMP & VOYAGER PKWY

Tuesday, April 26, 2022
 7:15 to 8:15AM
 Tuesday, April 26, 2022
 5:00 to 6:00PM

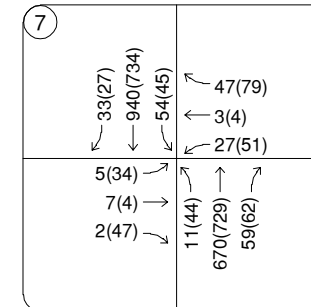

S. SPECTRUM LOOP & VOYAGER PKWY

Tuesday, April 26, 2022
 7:15 to 8:15AM
 Thursday, August 25, 2022
 3:00 to 4:00PM



LEGEND

(X) Study Area Key Intersection

XXX(XXX) Weekday AM(PM)
 Peak Hour Traffic Volumes

XX,X00 Estimated Daily Traffic Volume

FIGURE 3



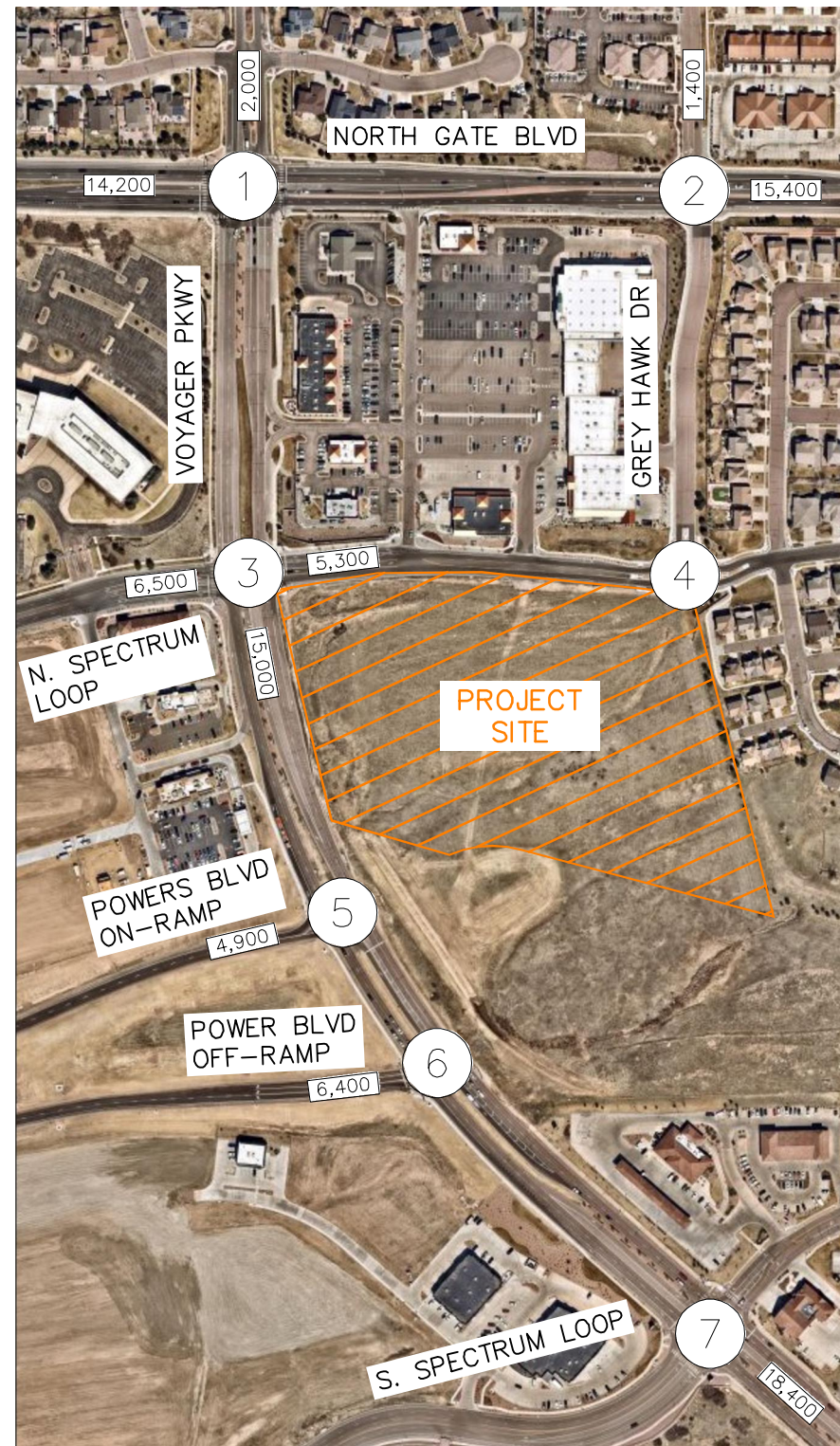

SPECTRUM AND VOYAGER
 COLORADO SPRINGS, COLORADO
 2024 BACKGROUND TRAFFIC VOLUMES

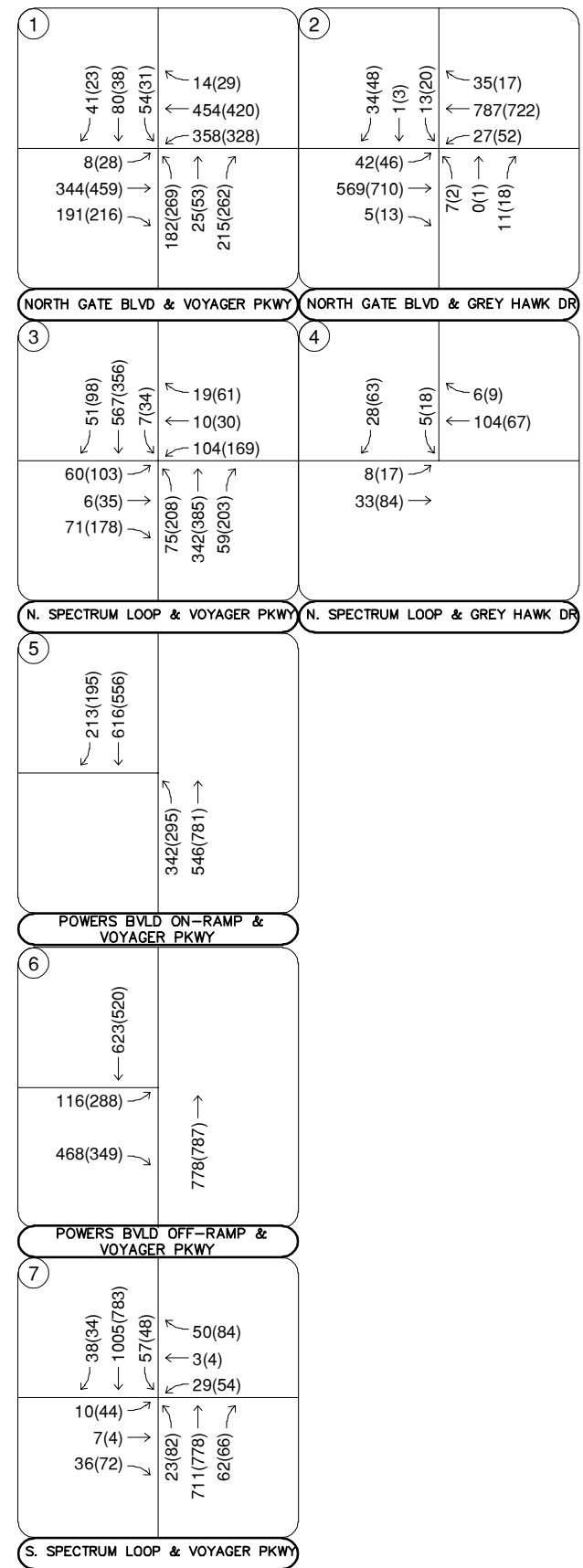

LEGEND

- (X) Study Area Key Intersection
- XXX(XXX) Weekday AM(PM) Peak Hour Traffic Volumes
- XX,X00 Estimated Daily Traffic Volume

FIGURE 4



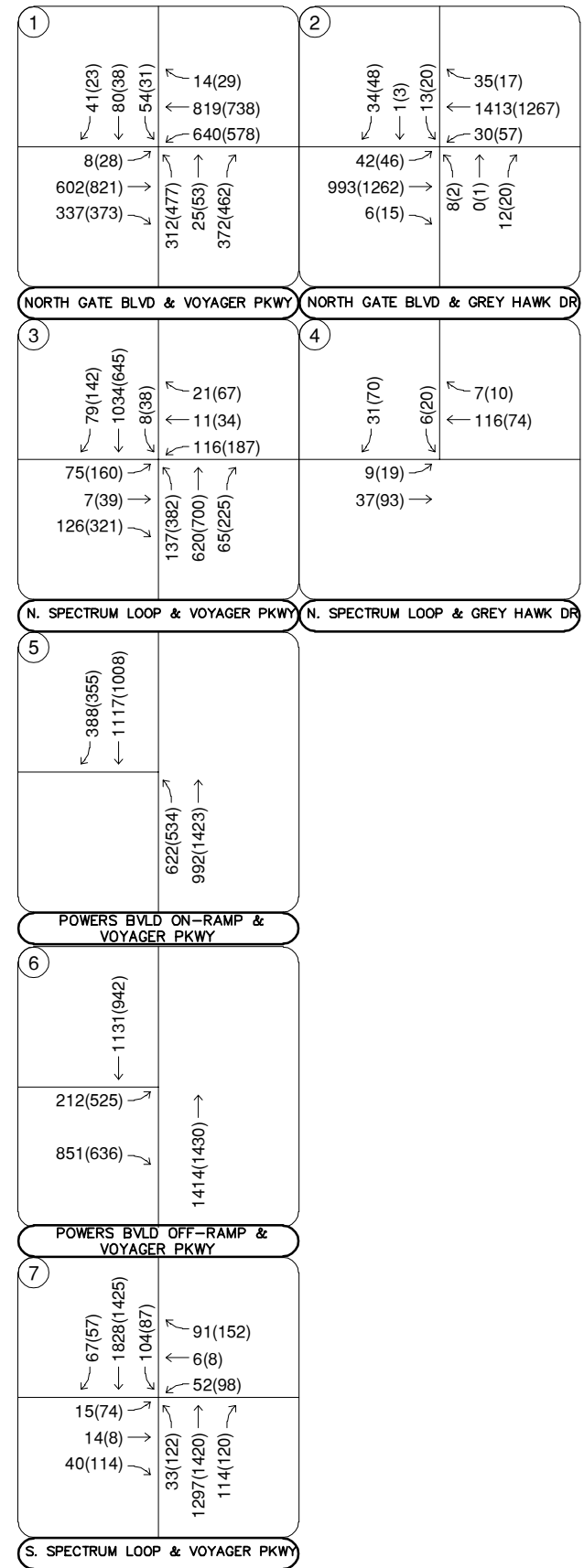
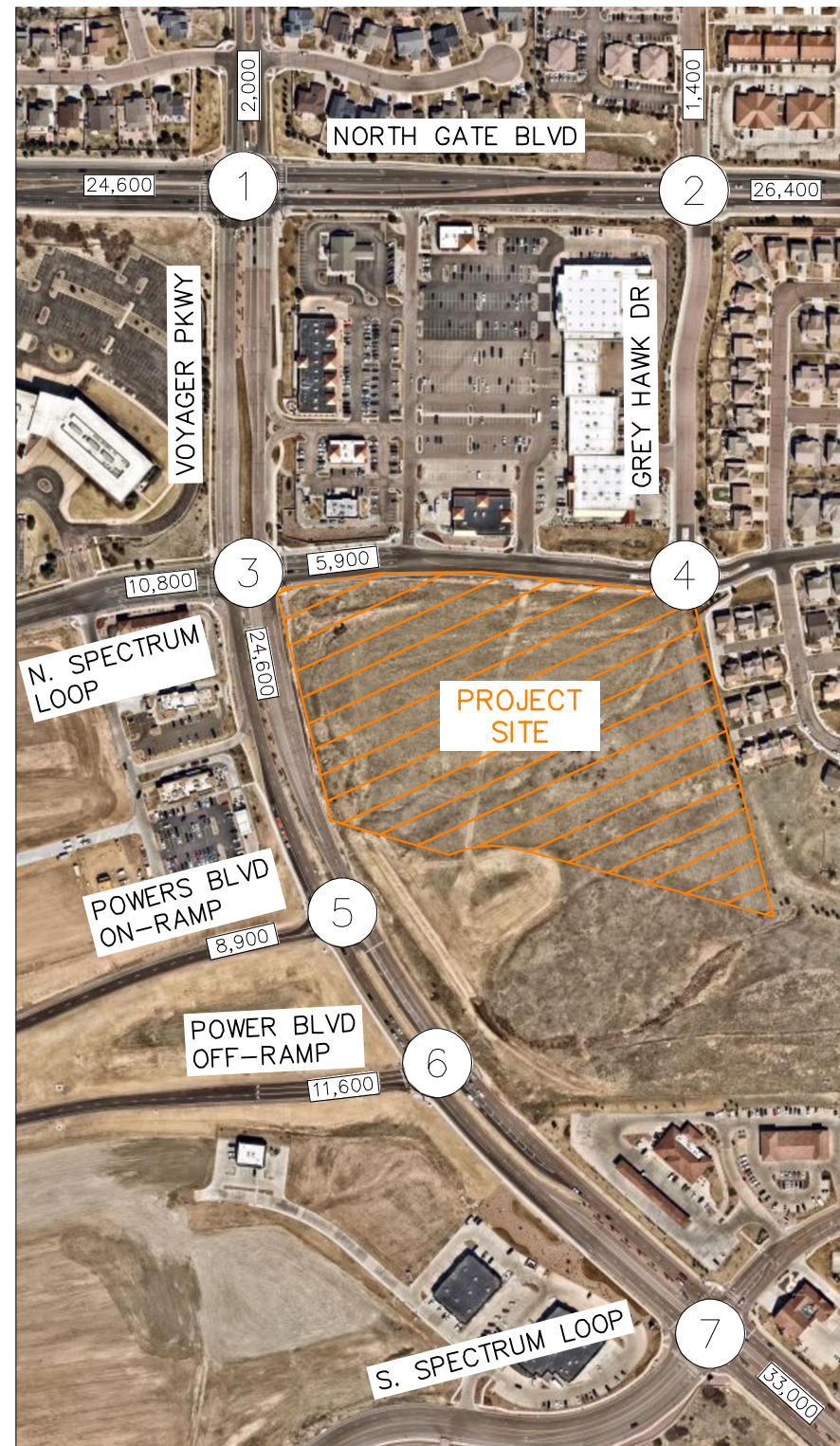

SPECTRUM AND VOYAGER
 COLORADO SPRINGS, COLORADO
 2045 BACKGROUND TRAFFIC VOLUMES



LEGEND

- (X) Study Area Key Intersection
- XXX(XXX) Weekday AM(PM) Peak Hour Traffic Volumes
- XX,X00 Estimated Daily Traffic Volume

FIGURE 5



4.0 PROJECT TRAFFIC CHARACTERISTICS

4.1 Trip Generation

Site-generated traffic estimates are determined through a process known as trip generation. Rates and equations are applied to the proposed land use to estimate traffic generated by the development during a specific time interval. The acknowledged source for trip generation rates is the *Trip Generation Manual*¹ published by the Institute of Transportation Engineers (ITE). ITE has established trip rates in nationwide studies of similar land uses. Additionally, entering and exiting volume counts were conducted at the Falcon View Apartments located at 10691 Cadence Point in Colorado Springs on Thursday, August 25, 2022, from 6:00 AM to 8:00 PM to determine trip generation rates at a similar land use in the vicinity of the project. Falcon View Apartments is currently 98 percent occupied and operates under the same ownership group as the project.

For this study, Kimley-Horn used the ITE Trip Generation Report average rate equations that apply to Multifamily Mid-Rise Housing (ITE Land Use Code 221) for the daily volumes and the morning peak hour, for traffic associated with the development as these rates were higher than the entering/exiting counts at the Falcon View Apartments. For the afternoon peak hour trip generation, a rate of 0.49 trips per dwelling unit was used based on the Falcon View Apartment counts as this rate is greater than the 0.39 trips per dwelling unit provided in the ITE Trip Generation Manual. For the purposes of this analysis, the maximum density scenario of approximately 355 multifamily housing units was included for evaluation in this study.

Spectrum and Voyager is expected to generate approximately 1,612 weekday daily trips, with 131 of these trips occurring during the morning peak hour and 174 of these trips occurring during the afternoon peak hour. Calculations were based on the procedure and information provided in the ITE *Trip Generation Manual, 11th Edition – Volume 1: User's Guide and Handbook*, 2021 and traffic counts at the Falcon View Apartments. **Table 1** summarizes the estimated trip generation for the Spectrum and Voyager project. The trip generation worksheets and Falcon View Apartment counts are included in **Appendix C**.

¹ Institute of Transportation Engineers, *Trip Generation Manual*, Eleventh Edition, Washington DC, 2021.

Table 1 – Spectrum and Voyager Traffic Generation

Land Use and Size	Weekday Vehicle Trips						
	Daily	AM Peak Hour			PM Peak Hour		
		In	Out	Total	In	Out	Total
Multifamily Mid-Rise Housing – (ITE Manual 221) – 355 Units	1,612	30	101	131	84	73	138
FalconView Apartment (Driveway Counts) – 290 Units	1,300	23	79	102	83	59	142
FalconView Apartment (Prorated to 355 Units)	1,592	28	97	125	101	73	174
Site Generated Traffic (Utilized in Analysis)	1,612	30	101	131	101	73	174

A diagram shown below also provides a comparison of the ITE Trip Generation calculations versus the user specific collected data. Of note, the highest data point of all three traffic count parameters was utilized in the analysis to provide a conservative evaluation.

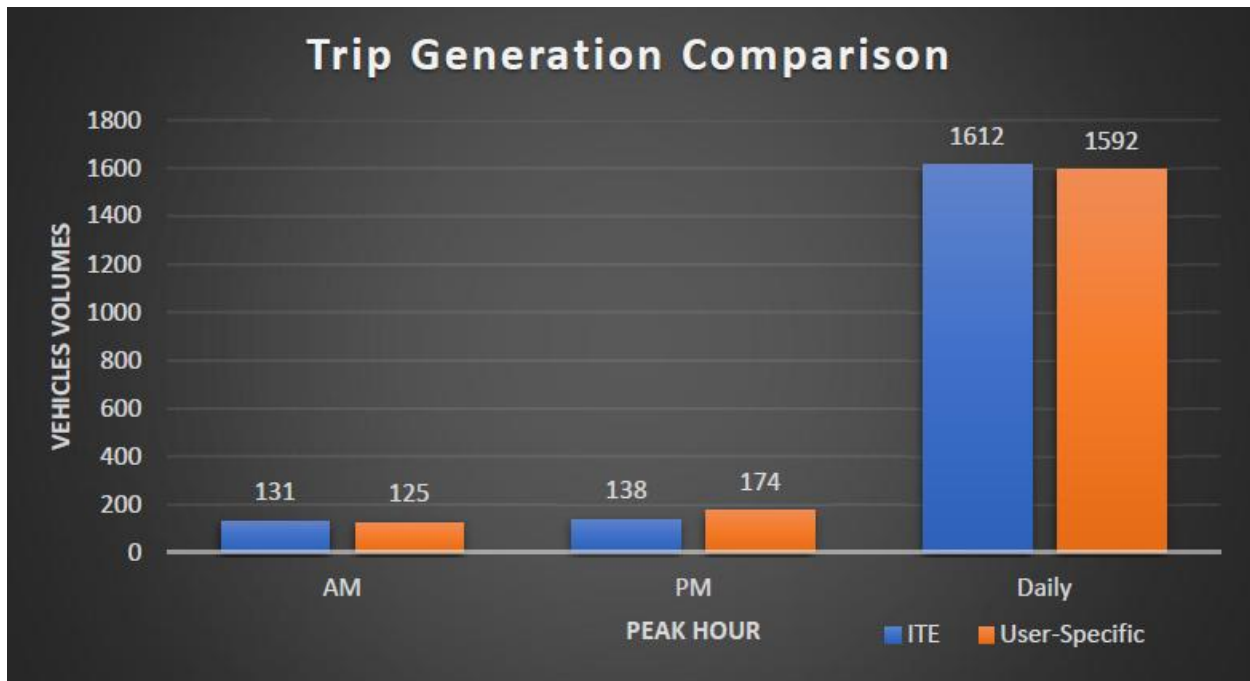

With development of this project, this parcel will be rezoned from agricultural use to residential land use. However, it should be noted that the Northgate Master Plan identified future office-industrial park use for the project site. As such, a trip generation comparison of a potential use from the Northgate Master Plan evaluated as office use (calculated using the 11th Edition average rates for General Office Building - ITE Land Use Code 710) was compared to the current proposal

evaluated as Multifamily Mid-Rise Housing (ITE Land Use Code 221 and Site-Specific). Based off the office buildings in the surrounding area, it is believed that a 200,000 square foot office building could be developed in this parcel. The following **Table 2** compares the trip generation of the Northgate Master Plan office use to the proposed residential zoning. The trip generation worksheets are included in **Appendix C**.

Table 2 – Trip Generation Comparison: Existing Zoning vs. Proposed Zoning

Land Use and Size	Weekday Vehicle Trips						
	Daily	AM Peak Hour			PM Peak Hour		
		In	Out	Total	In	Out	Total
Northgate Master Plan: Office Use							
General Office Building 200,000 Square Feet	2,168	268	36	304	49	239	288
Proposed Zoning: Residential							
Multifamily Mid-Rise Housing 355 Dwelling Units	1,612	30	101	131	101	73	174
Net Difference in Trips	-556	-238	+65	-173	+52	-166	-114

As summarized in **Table 2**, the Northgate Master Plan office use is anticipated to generate 2,168 daily weekday trips with 304 of these trips occurring during the morning peak hour and 288 of these trips occurring during the afternoon peak hour. Therefore, the proposed multifamily redevelopment is anticipated to account for a decrease in traffic of approximately 556 daily trips, a decrease of approximately 173 trips in the morning peak hour, and a decrease of approximately 114 trips in the afternoon peak hour compared to a use that could be developed in the existing zoning.

4.2 Trip Distribution

Distribution of site traffic on the street system was based on the area street system characteristics, existing traffic patterns, existing and anticipated surrounding demographic information, and the proposed access system for the project. The directional distribution of traffic is a means to quantify the percentage of site-generated traffic that approaches the site from a given direction and departs the site back to the original source. The project trip distribution for the proposed development is illustrated in **Figure 6**.

4.3 Traffic Assignment

Spectrum and Voyager traffic assignment was obtained by applying the project trip distribution to the estimated traffic generation of the development shown in **Table 1**. Traffic assignment is shown in **Figure 7**.

4.4 Total (Background Plus Project) Traffic

Site traffic volumes were added to the background volumes to represent estimated traffic conditions for the short-term 2024 buildout horizon and long-term 2045 twenty-year planning horizon. These total traffic volumes for the study area are illustrated for the 2024 and 2045 horizon years in **Figures 8** and **9**, respectively.

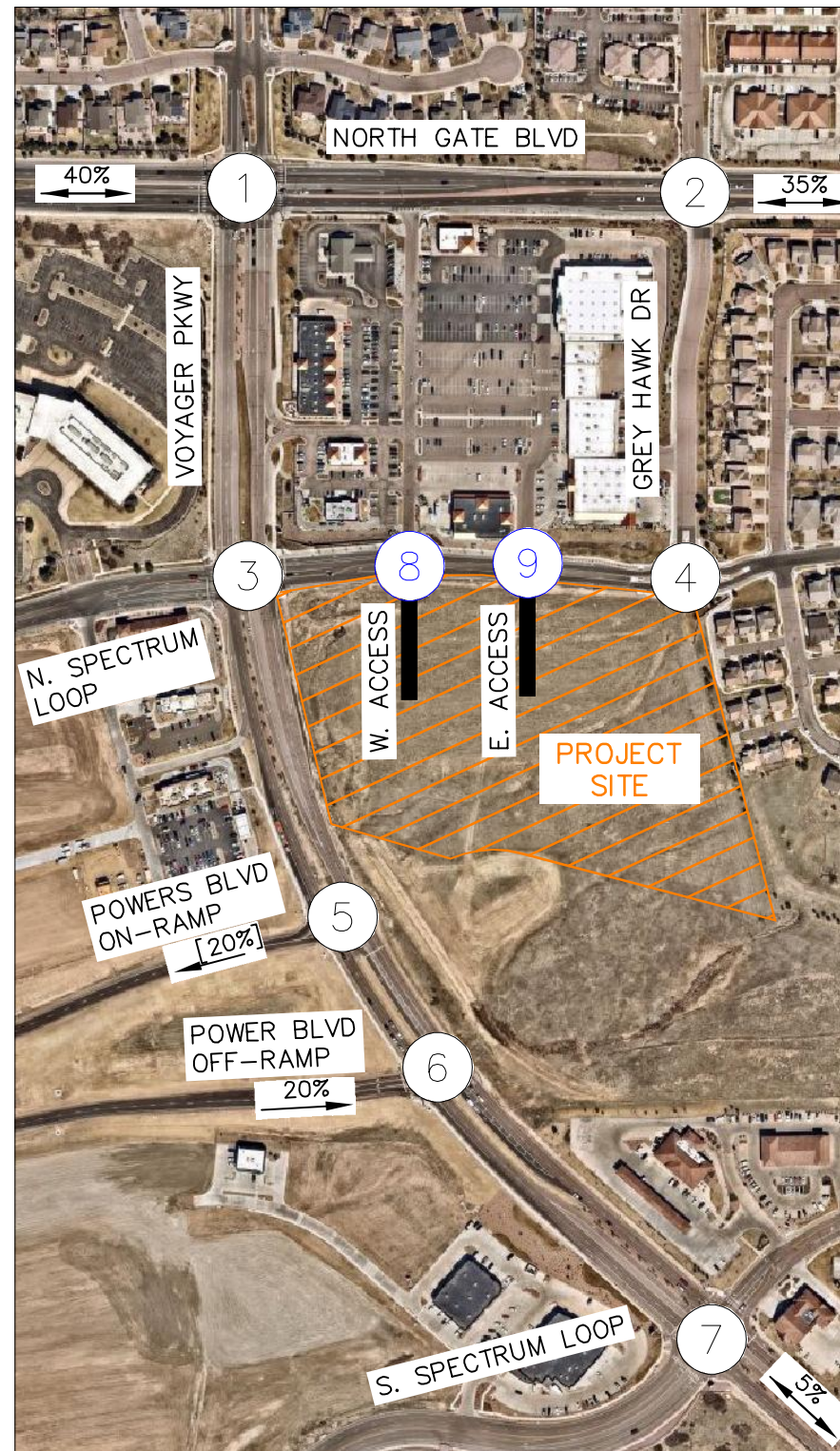

SPECTRUM AND VOYAGER
 COLORADO SPRINGS, COLORADO
 PROJECT TRIP DISTRIBUTION

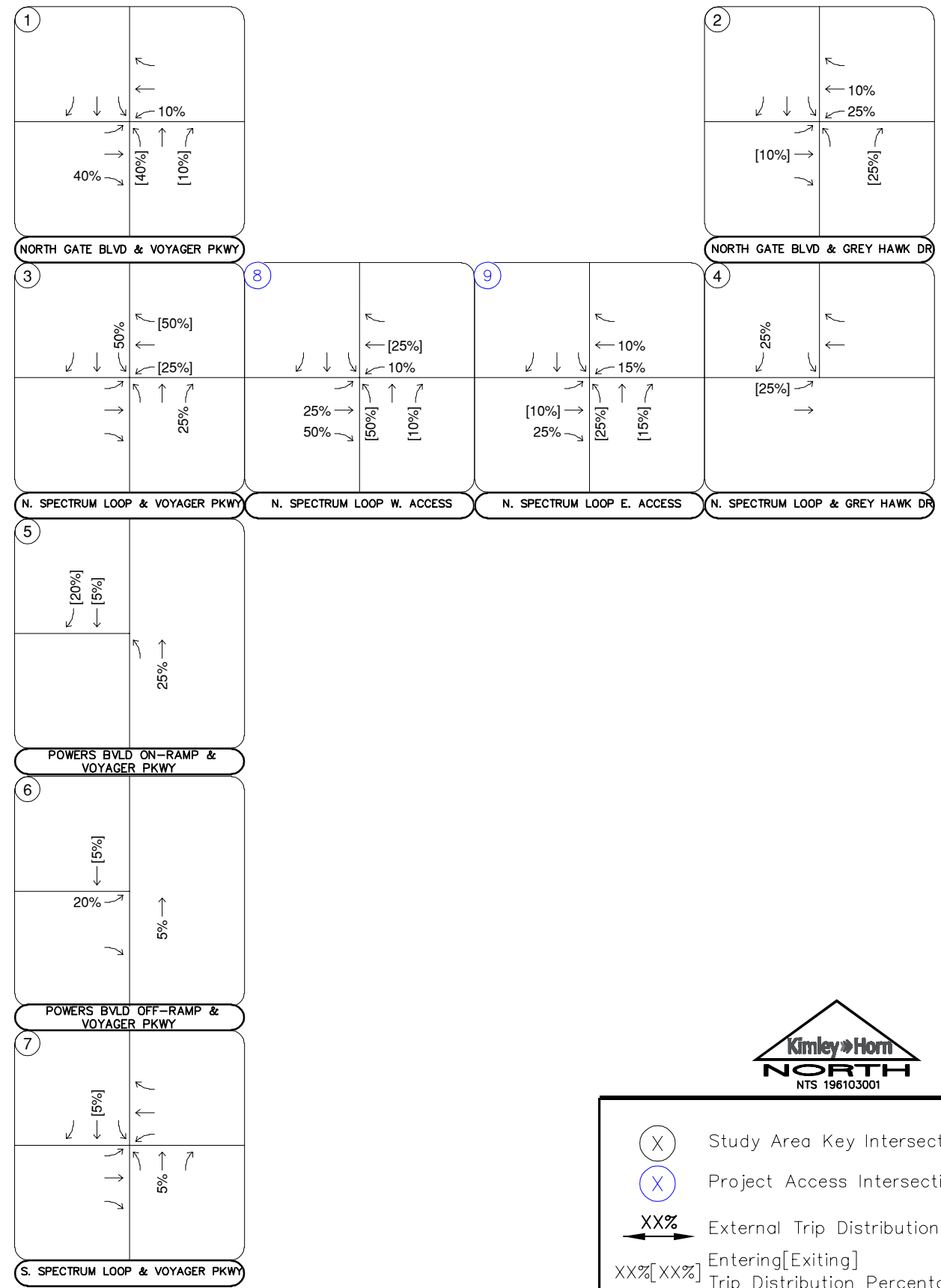

- X Study Area Key Intersection
- X Project Access Intersection
- $XX\%$ External Trip Distribution Percentage
- $XX\%[XX\%]$ Entering[Exiting] Trip Distribution Percentage

FIGURE 6



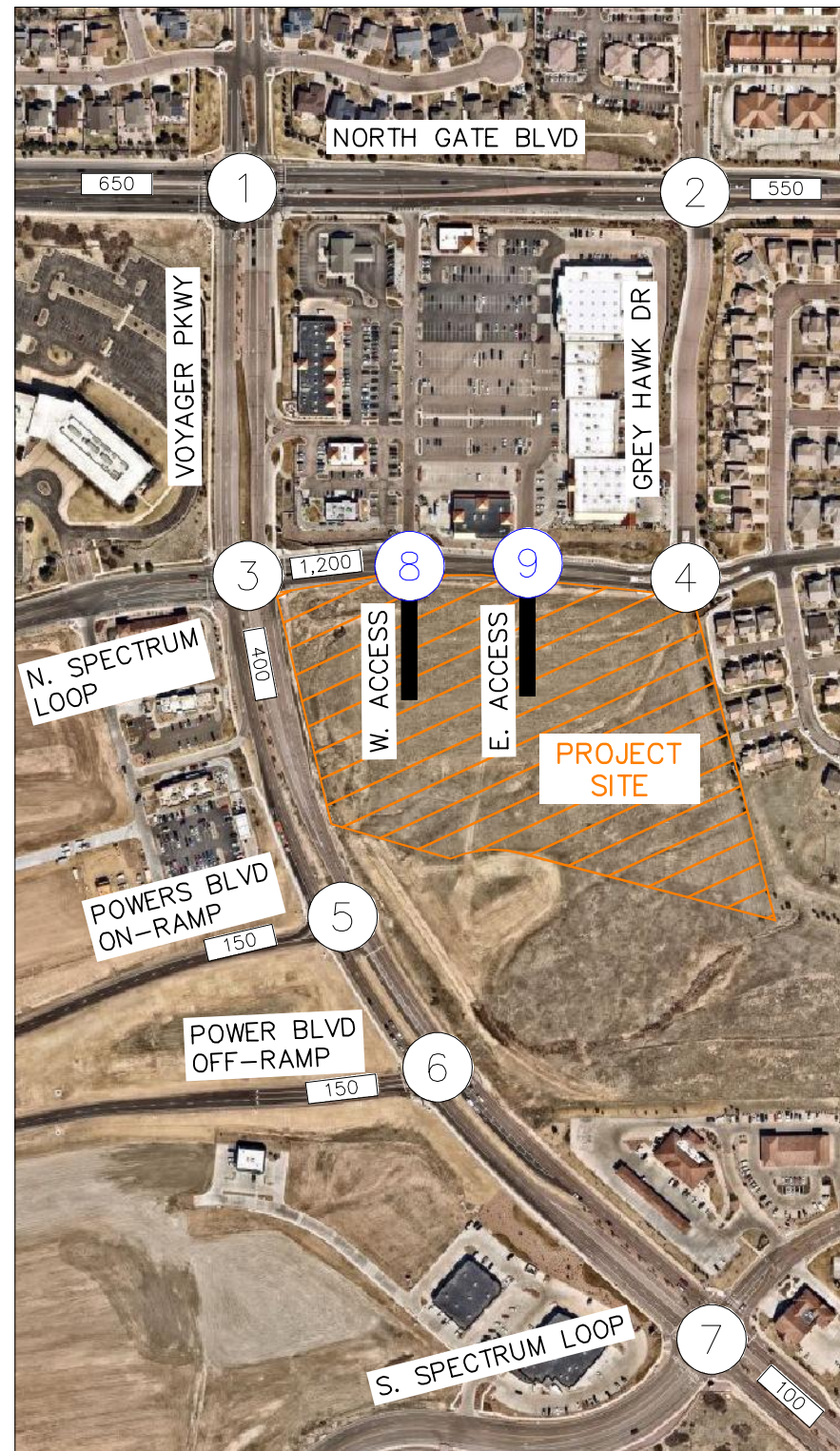

SPECTRUM AND VOYAGER
 COLORADO SPRINGS, COLORADO
 PROJECT TRAFFIC ASSIGNMENT

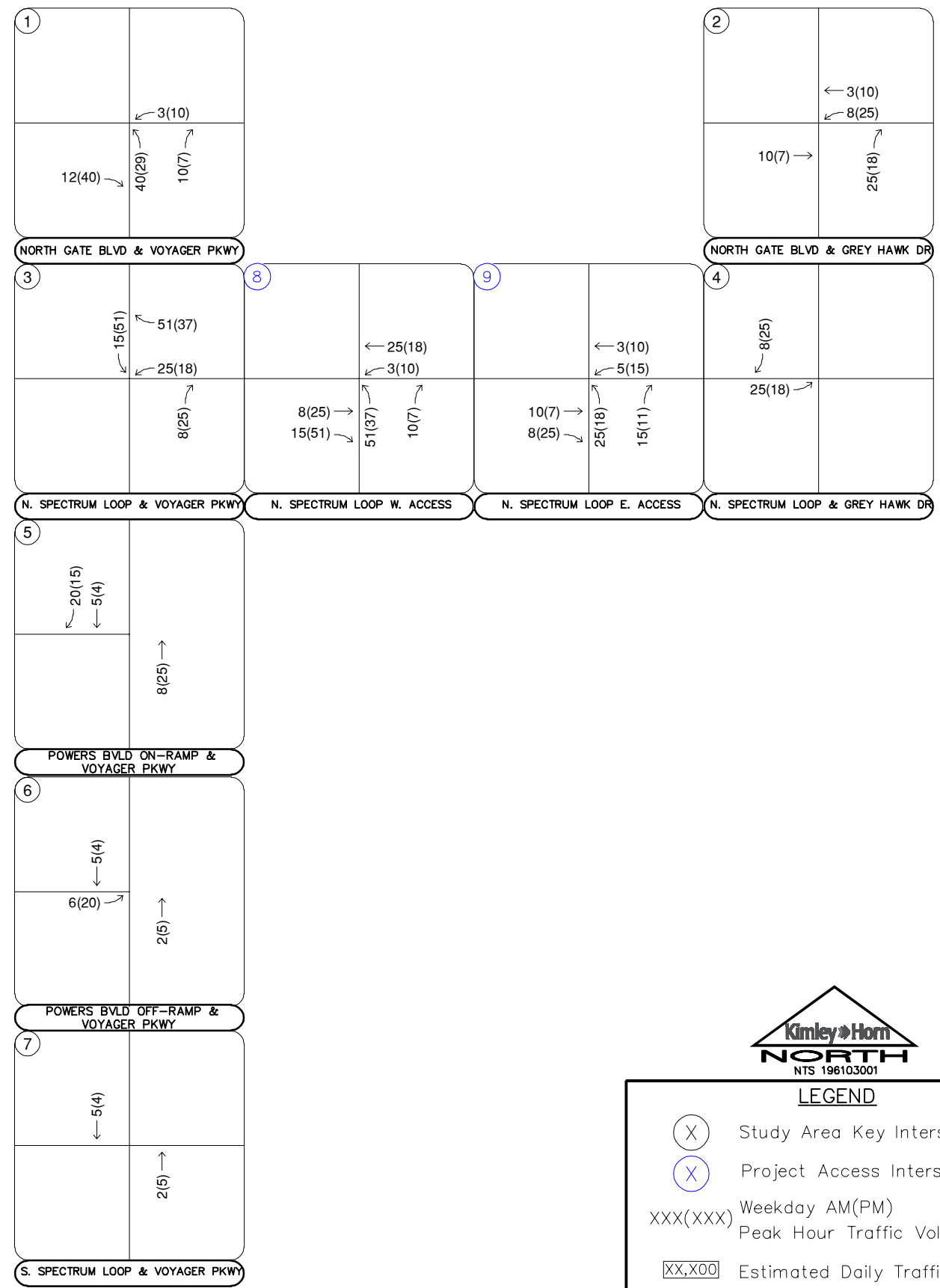

LEGEND

- (X) Study Area Key Intersection
- (X) Project Access Intersection
- XXX(XXX) Weekday AM(PM) Peak Hour Traffic Volumes
- XX,X00 Estimated Daily Traffic Volume

FIGURE 7



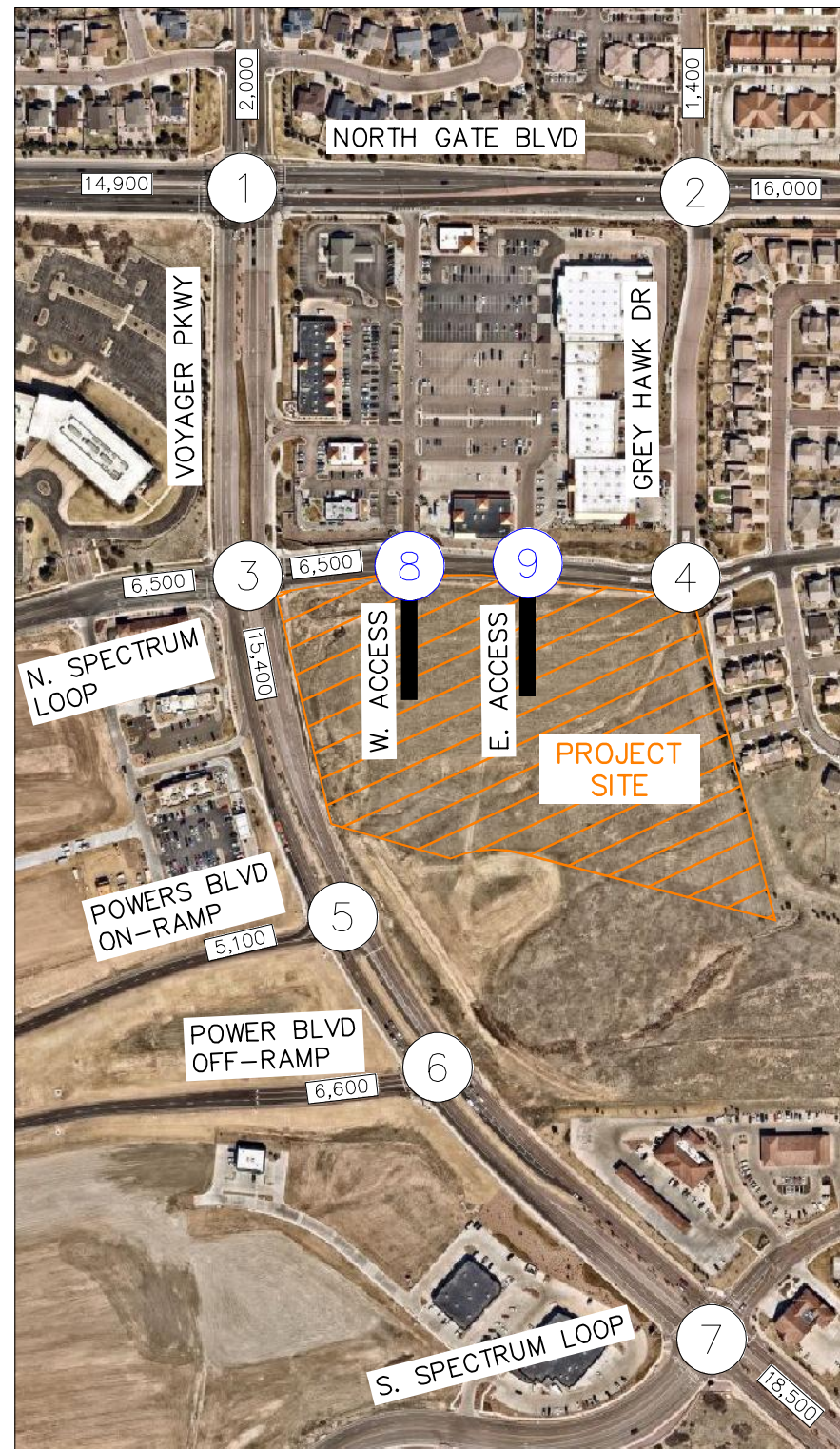

SPECTRUM AND VOYAGER
 COLORADO SPRINGS, COLORADO
 2024 TOTAL TRAFFIC VOLUMES

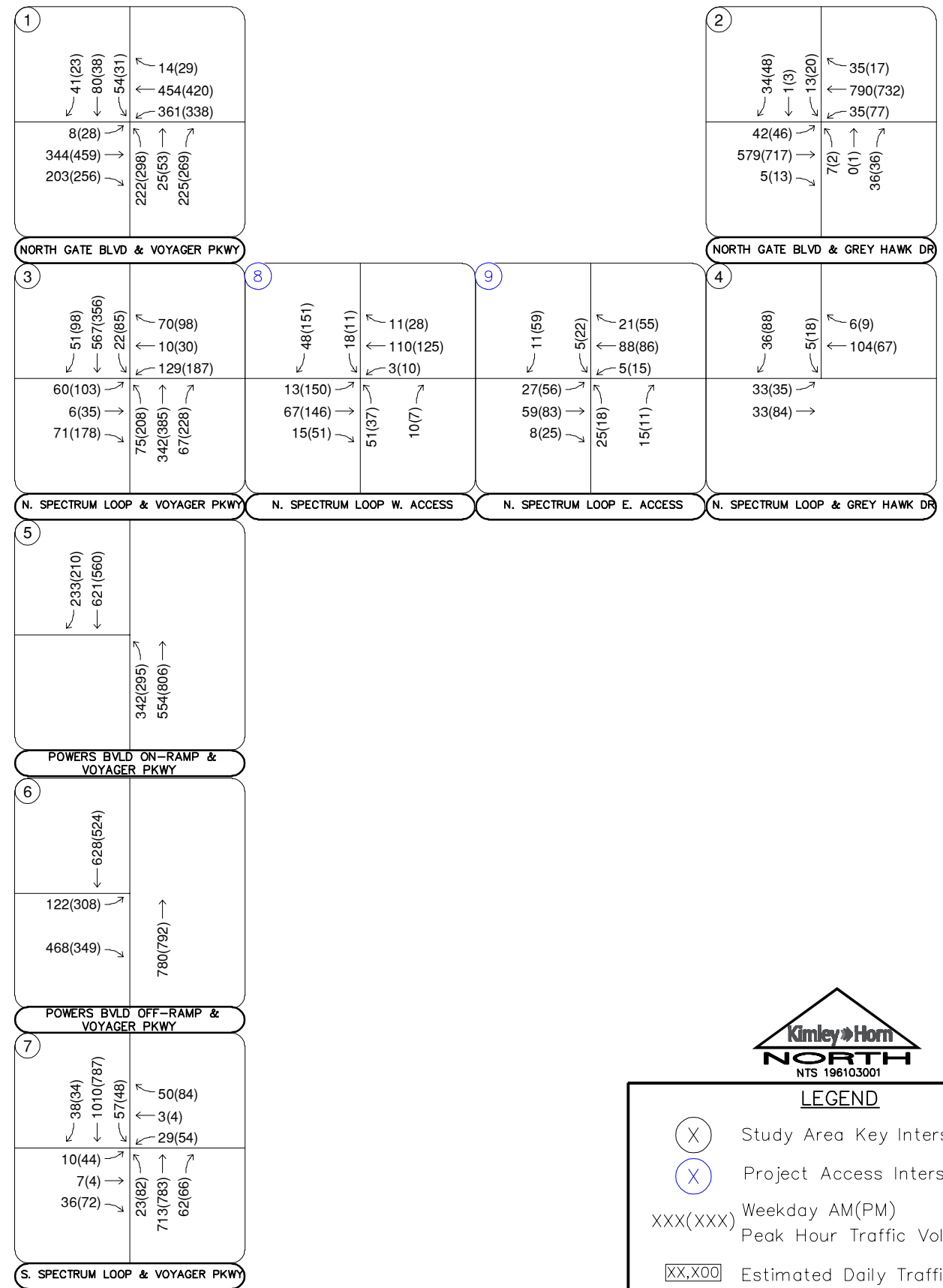

LEGEND

- (X) Study Area Key Intersection
- (X) Project Access Intersection
- XXX(XXX) Weekday AM(PM) Peak Hour Traffic Volumes
- XX.X00 Estimated Daily Traffic Volume

FIGURE 7



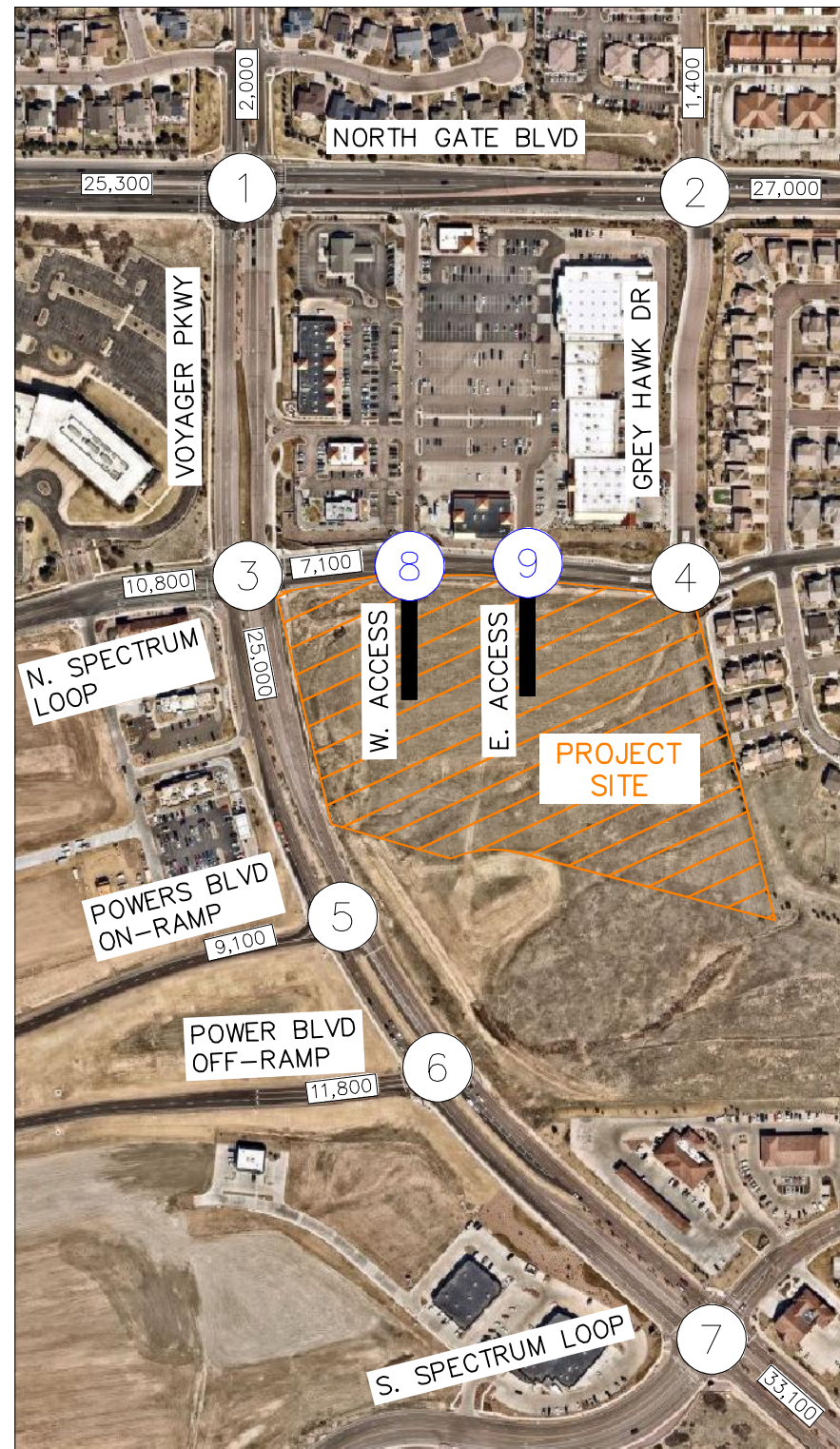

SPECTRUM AND VOYAGER
 COLORADO SPRINGS, COLORADO
 2045 TOTAL TRAFFIC VOLUMES

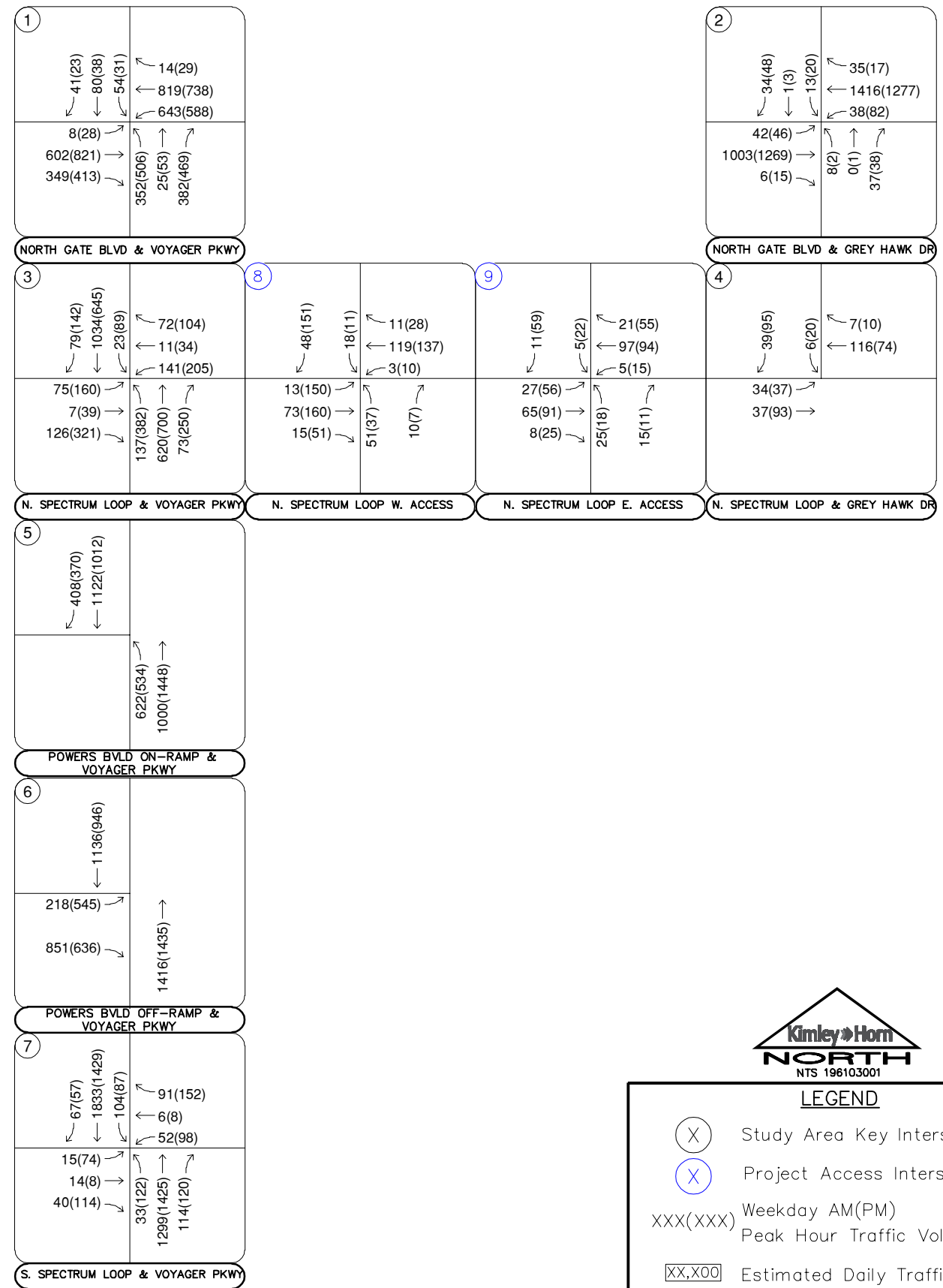

LEGEND

- (X) Study Area Key Intersection
- (X) Project Access Intersection
- XXX(XXX) Weekday AM(PM) Peak Hour Traffic Volumes
- XX,X00 Estimated Daily Traffic Volume

FIGURE 8



5.0 TRAFFIC OPERATIONS ANALYSIS

Kimley-Horn’s analysis of traffic operations in the site vicinity was conducted to determine potential capacity deficiencies in the 2024 and 2045 development horizons at the identified key intersections. The acknowledged source for determining overall capacity is the current edition of the *Highway Capacity Manual (HCM)*².

5.1 Analysis Methodology

Capacity analysis results are listed in terms of Level of Service (LOS). LOS is a qualitative term describing operating conditions a driver will experience while traveling on a particular street or highway during a specific time interval. It ranges from A (very little delay) to F (long delays and congestion). For intersections and roadways in this study area, standard traffic engineering practice recommends overall intersection LOS D and movement/approach LOS E as the minimum desirable thresholds for acceptable operations. **Table 3** shows the definition of level of service for signalized and unsignalized intersections.

Table 3 – Level of Service Definitions

Level of Service	Signalized Intersection Average Total Delay (sec/veh)	Unsignalized Intersection Average Total Delay (sec/veh)
A	≤ 10	≤ 10
B	> 10 and ≤ 20	> 10 and ≤ 15
C	> 20 and ≤ 35	> 15 and ≤ 25
D	> 35 and ≤ 55	> 25 and ≤ 35
E	> 55 and ≤ 80	> 35 and ≤ 50
F	> 80	> 50

Definitions provided from the Highway Capacity Manual, Sixth Edition, Transportation Research Board, 2016.

Study area intersections were analyzed based on average total delay analysis for signalized and unsignalized intersections. Under the unsignalized analysis, the LOS for a two-way stop-controlled intersection is determined by the computed or measured control delay and is defined for each minor movement. LOS for a two-way stop-controlled intersection is not defined for the intersection as a whole. LOS for signalized, roundabout, and all-way stop controlled intersections are defined for each approach and for the overall intersection.

² Transportation Research Board, *Highway Capacity Manual*, Sixth Edition, Washington DC, 2016.

5.2 Key Intersection Operational Analysis

Calculations for the operational level of service at the key intersections for the study area are provided in **Appendix D**. The existing year analysis is based on the lane geometry and intersection control shown in **Figure 2**. Existing peak hour factors were utilized in the existing and 2024 horizon analysis years while the HCM urban standard of 0.92 was used for the long-term 2045 horizon analysis. The signalized intersection analysis utilizes the signal phasing and timings provided by the City of Colorado Springs. The existing signal timings are attached in **Appendix E**. Synchro traffic analysis software was used to analyze the signalized, and unsignalized key intersections for HCM level of service.

North Gate Boulevard and Voyager Parkway (#1)

The signalized intersection of North Gate Boulevard and Voyager Parkway (#1) operates with protected-permissive left turn phasing on the eastbound, westbound, and southbound approaches and protected-only left turn phasing on the northbound approach. The intersection operates acceptably at LOS C during both peak hours under existing conditions and is expected to continue to operate acceptably through the short-term 2024 horizon. Without the addition of project traffic, the intersection is anticipated to operate at LOS F in 2045 with optimized signal timings. Therefore, it is recommended that a second westbound left turn lane be striped in addition to optimizing the signal splits by 2045 if traffic volumes are realized. **Table 4** provides the results of the LOS analysis conducted at this intersection.

Table 4 – North Gate Boulevard & Voyager Parkway (#1) LOS Results

Scenario	AM Peak Hour		PM Peak Hour	
	Delay (sec/veh)	LOS	Delay (sec/veh)	LOS
2022 Existing	25.9	C	28.7	C
2024 Background	28.2	C	30.9	C
2024 Background Plus Project	29.4	C	32.0	C
2045 Background #	71.0	E	89.3	F
2045 Background Plus Project ##	47.7	D	54.8	D

= Optimized signal timings

= # + Dual westbound left turn lanes

North Gate Boulevard and Grey Hawk Drive (#2)

The unsignalized intersection of North Gate Boulevard and Grey Hawk Drive (#2) operates with stop control on the northbound and southbound Grey Hawk Drive approaches. The intersection movements operate acceptably at LOS C or better during both peak hours under existing conditions. With project traffic, all movements are anticipated to continue operating at an acceptable level of service throughout the 2024 horizon. However, by 2045 the shared southbound left turn/through movement is anticipated to operate at LOS F during the morning peak hour without the addition of project hour traffic. It is believed that this intersection will not warrant a signal by 2045. If long delays are present in 2045, it is believed drivers will reroute to the intersection of North Gate Boulevard and Voyager Parkway (#1) to the west. It should be noted that project traffic does not contribute to the shared southbound left turn/through movement. **Table 5** provides the results of the LOS analysis conducted at this intersection.

Table 5 – North Gate Boulevard & Grey Hawk Drive (#2) LOS Results

Scenario	AM Peak Hour		PM Peak Hour	
	Delay (sec/veh)	LOS	Delay (sec/veh)	LOS
2022 Existing				
Northbound Left/Through	13.9	B	15.5	C
Northbound Right	9.1	A	9.5	A
Eastbound Left	9.8	A	9.3	A
Westbound Left	7.8	A	8.1	A
Southbound Left/Through	18.1	C	17.7	C
Southbound Right	11.3	B	11.0	B
2024 Background				
Northbound Left/Through	14.4	B	16.7	C
Northbound Right	9.3	A	9.7	A
Eastbound Left	10.1	B	9.7	A
Westbound Left	7.9	A	8.2	A
Southbound Left/Through	19.6	C	19.6	C
Southbound Right	11.7	B	11.4	B
2024 Background Plus Project				
Northbound Left/Through	14.7	B	18.0	C
Northbound Right	9.5	A	9.8	A
Eastbound Left	10.1	B	9.7	A
Westbound Left	8.0	A	8.3	A
Southbound Left/Through	20.1	C	21.3	C
Southbound Right	11.7	B	11.5	B
2045 Background				
Northbound Left/Through	23.2	C	29.4	D
Northbound Right	10.6	B	11.8	B
Eastbound Left	14.7	B	13.1	B
Westbound Left	8.8	A	9.7	A
Southbound Left/Through	50.6	F	46.5	E
Southbound Right	16.7	C	15.5	C
2045 Background Plus Project				
Northbound Left/Through	23.8	C	33.0	D
Northbound Right	10.8	B	12.0	B
Eastbound Left	14.8	B	13.2	B
Westbound Left	8.8	A	9.9	A
Southbound Left/Through	52.3	F	51.8	F
Southbound Right	16.8	C	15.7	C

North Spectrum Loop and Voyager Parkway (#3)

The signalized intersection of North Spectrum Loop and Voyager Parkway (#3) operates with protected-only left turn phasing on northbound and southbound approaches and permissive-only left turn phasing on the eastbound and westbound approaches. The intersection operates unacceptably at LOS E during the afternoon peak hour under existing conditions. The left turning signal heads on the northbound and southbound approaches of this intersection currently include four-ball heads with capabilities of operating with protective-permissive left turn phasing. Therefore, it is recommended that the City consider changing the northbound and southbound left turn phasing to protected-permissive to improve vehicle delays. With protective-permissive left turn phasing and optimized signal splits, the intersection is anticipated to operate at an acceptable level of service throughout the 2045 horizon. **Table 6** provides the results of the LOS analysis conducted at this intersection.

Table 6 – North Spectrum Loop & Voyager Parkway (#3) LOS Results

Scenario	AM Peak Hour		PM Peak Hour	
2022 Existing	18.8	B	58.1	E
2024 Background	20.3	C	64.4	E
2024 Background Plus Project	23.0	C	64.0	E
2024 Background Plus Project #	17.1	B	20.7	C
2045 Background #	14.2	B	14.2	B
2045 Background Plus Project #	15.8	B	25.0	C

= Protected-permissive northbound and southbound left turn phasing and optimized signal splits

North Spectrum Loop and Grey Hawk Drive (#4)

The unsignalized ‘T’-intersection of North Spectrum Loop and Grey Hawk Drive (#4) operates as a roundabout with yield control on eastbound, westbound, and southbound approaches. The intersection operates acceptably at LOS A during both peak hours under existing conditions. With project traffic, the intersection is anticipated to continue operating at an acceptable level of service throughout the 2045 horizon. Therefore, no improvements or modifications are anticipated to be needed at this intersection based on the addition of project traffic and this operational level of service analysis. **Table 7** provides the results of the LOS analysis conducted at this intersection.

Table 7 – North Spectrum Loop & Grey Hawk Drive (#4) LOS Results

Scenario	AM Peak Hour		PM Peak Hour	
	Delay (sec/veh)	LOS	Delay (sec/veh)	LOS
2022 Existing	3.4	A	3.3	A
2024 Background	3.4	A	3.4	A
2024 Background Plus Project	3.5	A	3.5	A
2045 Background	3.3	A	3.4	A
2045 Background Plus Project	3.4	A	3.6	A

Powers Boulevard On-Ramp and Voyager Parkway (#5)

The signalized intersection of Powers Boulevard On-Ramp and Voyager Parkway (#5) operates with protected-only left turn phasing on the northbound approach. The intersection operates acceptably at LOS B or better during both peak hours under existing conditions. With project traffic, the intersection is anticipated to continue operating at an acceptable level of service throughout the 2045 horizon. Therefore, no improvements or modifications are anticipated to be needed at this intersection based on the addition of project traffic and this operational level of service analysis. **Table 8** provides the results of the LOS analysis conducted at this intersection.

Table 8 – Powers Boulevard On-Ramp & Voyager Parkway (#5) LOS Results

Scenario	AM Peak Hour		PM Peak Hour	
	Delay (sec/veh)	LOS	Delay (sec/veh)	LOS
2022 Existing	11.9	B	7.9	A
2024 Background	10.4	B	8.0	A
2024 Background Plus Project	10.4	B	7.9	A
2045 Background	15.6	B	5.9	A
2045 Background Plus Project	15.6	B	9.8	A

Powers Boulevard Off-Ramp and Voyager Parkway (#6)

The signalized intersection of Powers Boulevard Off-Ramp and Voyager Parkway (#6) operates with protected-only left turn phasing on the eastbound approach. The intersection operates acceptably at LOS B or better during both peak hours under existing conditions. With project traffic, the intersection is anticipated to continue operating at an acceptable level of service throughout the 2045 horizon. Therefore, no improvements or modifications are anticipated to be needed at this intersection based on the addition of project traffic and this operational level of service analysis. **Table 9** provides the results of the LOS analysis conducted at this intersection.

Table 9 – Powers Boulevard Off-Ramp & Voyager Parkway (#6) LOS Results

Scenario	AM Peak Hour		PM Peak Hour	
	Delay (sec/veh)	LOS	Delay (sec/veh)	LOS
2022 Existing	4.9	A	10.8	B
2024 Background	6.7	A	9.5	A
2024 Background Plus Project	6.9	A	13.0	B
2045 Background	6.3	A	12.0	B
2045 Background Plus Project	6.4	A	12.3	B

South Spectrum Loop and Voyager Parkway (#7)

The signalized intersection of South Spectrum Loop and Voyager Parkway (#7) operates with protected-only left turn phasing on the northbound and southbound approaches and permitted-only left turn phasing on the eastbound and westbound approaches. The intersection operates acceptably at LOS B or better during both peak hours under existing conditions. With project traffic, the intersection is anticipated to continue operating at an acceptable level of service throughout the 2045 horizon. Therefore, no improvements or modifications are anticipated to be needed at this intersection based on the addition of project traffic and this operational level of service analysis. **Table 10** provides the results of the LOS analysis conducted at this intersection.

Table 10 – Powers Boulevard Off-Ramp & Voyager Parkway (#6) LOS Results

Scenario	AM Peak Hour		PM Peak Hour	
	Delay (sec/veh)	LOS	Delay (sec/veh)	LOS
2022 Existing	7.5	A	13.3	B
2024 Background	9.1	A	15.0	B
2024 Background Plus Project	9.1	A	14.9	B
2045 Background	10.0	B	17.4	B
2045 Background Plus Project	11.0	B	17.7	B

Project Accesses

With completion of the Spectrum and Voyager project, two project accesses are proposed along the south side of North Spectrum Loop. The west access (#8) and the east access (#9) both will align with existing full movement accesses to the retail center to the north. It is recommended that a R1-1 "STOP" sign be installed on the exiting northbound approaches of both accesses. A single exiting lane for all movements should be sufficient at both accesses. Due to the westbound left turn lane queues at the intersection of North Spectrum Loop and Voyager Parkway (#3) to the west, the North Spectrum Loop West Access (#8) was analyzed as a full movement access and a right-in/right-out access. The North Spectrum Loop East Access (#9) was analyzed as a full movement access for both scenarios.

With a full movement access at the North Spectrum Loop West Access (#9), the two-way left turn lane that is currently striped at both proposed accesses will provide left turn movements for entering the proposed development. **Table 11** provides the results of the level of service for the proposed full movement project access intersections. As shown in the table, the project access intersections along North Spectrum Loop are anticipated to have all movements operating with acceptable LOS C or better during the peak hours in both the buildout year 2024 and the 2045 long term horizons with a full movement access at the North Spectrum Loop West Access (#9).

If the North Spectrum Loop West Access (#9) were restricted to right-in/right-out movements due to long vehicle queues, a raised center median would be constructed along Spectrum Loop to restrict left turning movements at this access. **Table 11** also provides the results of the level of service for the proposed project access intersections with a right-in/right-out access at the North Spectrum Loop West Access (#9). As shown in the table, the project access intersections along North Spectrum Loop are anticipated to have all movements operating with acceptable LOS C or better during the peak hours in both the buildout year 2024 and the 2045 long term horizons with a right-in/right-out access at the North Spectrum Loop West Access (#9).

Table 11 – Project Access Level of Service Results

Intersection	2024 Total				2025 Total			
	AM Peak Hour		PM Peak Hour		AM Peak Hour		PM Peak Hour	
	Delay (sec/veh)	LOS	Delay (sec/veh)	LOS	Delay (sec/veh)	LOS	Delay (sec/veh)	LOS
Full Access at North Spectrum Loop West Access (#8)								
North Spectrum Loop West Access (#8)								
Northbound Approach	10.5	B	16.5	C	10.6	B	16.9	C
Eastbound Left	7.5	A	7.9	A	7.5	A	7.9	A
Westbound Left	7.4	A	7.6	A	7.4	A	7.7	A
Southbound Approach	9.5	A	10.5	B	9.6	A	10.7	B
North Spectrum Loop East Access (#9)								
Northbound Approach	9.5	A	10.2	B	9.5	A	10.3	B
Eastbound Left	7.5	A	7.6	A	7.5	A	7.7	A
Westbound Left	7.4	A	7.5	A	7.4	A	7.5	A
Southbound Approach	9.2	A	9.8	A	9.2	A	9.9	A
Right-In/Right-Out Access at North Spectrum Loop West Access (#8)								
North Spectrum Loop West Access (#8)								
Northbound Approach	8.6	A	9.5	A	8.7	A	9.5	A
Southbound Approach	9.4	A	10.2	B	9.5	A	10.3	B
North Spectrum Loop East Access (#9)								
Northbound Approach	10.3	B	15.0	C	10.4	B	15.2	C
Eastbound Left	7.5	A	8.0	A	7.5	A	8.0	A
Westbound Left	7.3	A	7.4	A	7.3	A	7.5	A
Southbound Approach	9.7	A	11.9	B	9.8	A	12.0	B

5.3 Vehicle Queuing Analysis

A vehicle queuing analysis was conducted for the study area intersections. The queuing analysis was performed using Synchro presenting the results of the 95th percentile queue lengths. Results are shown in the following **Table 12** with calculations provided within the level of service operational sheets of **Appendix D** for unsignalized intersections and **Appendix F** for signalized intersections.

Table 12 – Turn Lane Queuing Analysis Results

Intersection Turn Lane	Existing Turn Lane Length (feet)	2024 Calculated Queue (feet)	2024 Recommended Length (feet)	2025 Calculated Queue (feet)	2025 Recommended Length (feet)
North Gate Blvd & Voyager Pkwy (#1)					
Eastbound Left	275'	25'	275'	27'	275'
Westbound Left	400'	215'	400'	315'	400' DL
Westbound Right	250'	25'	250'	25'	250'
Northbound Left	275'/C	130'	275'/C	254'	275'/C
Southbound Left	100'	63'	100'	63'	100'
Southbound Right	100'	25'	100'	25'	100'
North Gate Blvd & Grey Hawk Dr (#2)					
Eastbound Left	175'	25'	175'	25'	175'
Eastbound Right	125'	25'	125'	25'	125'
Westbound Left	225'	25'	225'	25'	225'
Westbound Right	150'	25'	150'	25'	150'
Northbound Right	75'	25'	75'	25'	75'
Southbound Right	75'	25'	75'	25'	75'
Powers Blvd On-Ramp & Voyager Pkwy (#5)					
Northbound Left	250'+300'	294'	250'+300'	366'	250'+300'
Southbound Right	250'	25'	250'	25'	250'
Powers Blvd Off-Ramp & Voyager Pkwy (#6)					
Eastbound Left	325'/C DL	97'	325'/C DL	152'	325'/C DL
South Spectrum Loop & Voyager Pkwy (#7)					
Eastbound Right	350'	50'	350'	58'	350'
Westbound Left	150'	99'	150'	153'	150'
Westbound Right	125'	53'	125'	65'	125'
Northbound Left	450'	133'	450'	182'	450'
Northbound Right	200'	25'	200'	45'	200'
Southbound Left	400'	93'	400'	156'	400'
Full Access at North Spectrum Loop West Access (#8)					
North Spectrum Loop & Voyager Pkwy (#3)					
Eastbound Left	200'	134'	200'	197'	200'
Westbound Left	100'	239'	240'	253'	240'
Westbound Right	225'	45'	225'	45'	225'
Northbound Left	525'	125'	525'	315'	525'
Northbound Right	250'	61'	250'	68'	250'
Southbound Left	200'	55'	200'	60'	200'

Intersection Turn Lane	Existing Turn Lane Length (feet)	2024 Calculated Queue (feet)	2024 Recommended Length (feet)	2045 Calculated Queue (feet)	2045 Recommended Length (feet)
North Spectrum Loop West Access (#8)					
Eastbound Left	75'	25'	200'	25'	200'
Westbound Left	TWLTL	25'	TWLTL	25'	TWLTL
North Spectrum Loop East Access (#9)					
Eastbound Left	TWLTL	25'	TWLTL	25'	TWLTL
Westbound Left	TWLTL	25'	TWLTL	25'	TWLTL
Right-In/Right-Out Access at North Spectrum Loop West Access (#8)					
North Spectrum Loop & Voyager Pkwy (#3)					
Eastbound Left	200'	134'	200'	197'	200'
Westbound Left	100'	239'	250'+100'T	253'	250'+100'T
Westbound Right	225'	45'	225'	45'	225'
Northbound Left	525'	125'	525'	315'	525'
Northbound Right	250'	61'	250'	68'	250'
Southbound Left	200'	55'	200'	60'	200'
North Spectrum Loop East Access (#9)					
Eastbound Left	TWLTL	25'	150'+100'T	25'	150'+100'T
Westbound Left	TWLTL	25'	TWLTL	25'	TWLTL

C = Continuous; DL = Dual Left Turn Lanes; TWLTL = Two-Way Left Turn Lane; **Red** Text = Storage Deficiency; **Blue** Text = Recommendation; T = Taper

As shown in the table above, vehicle queues are all expected to be managed within the available storage length throughout 2024 with the exception of the westbound left turn lane at the intersection of North Spectrum Loop and Voyager Parkway (#3).

If the North Spectrum Loop West Access (#8) remains a full movement access, it is recommended that the westbound left turn lane at the intersection of North Spectrum Loop and Voyager Parkway (#3) be designated to a maximum length of 240 feet. This would require the eastbound left turn lane at the North Spectrum Loop West Access (#8) to be side by side with the westbound left turn lane at the intersection of North Spectrum Loop and Voyager Parkway (#3) and designated to a length of 200 feet. If the North Spectrum Loop West Access (#8) were restricted to right turn movements only, it is recommended that the westbound left turn lane at the intersection of North Spectrum Loop and Voyager Parkway (#3) be designated to a maximum length of 250 feet with a 100-foot taper. This 100-foot taper would be shared with the eastbound left turn lane at the North Spectrum Loop East Access (#9) which would be designated to a maximum length of 150 feet. A conceptual improvement exhibit is attached in **Appendix G** for the side-by-side left turn lane configuration with the scenario of the west access remaining full turning movements.

Likewise, a conceptual improvement exhibit is also attached in **Appendix G** with the scenario of the west access being a restricted to right-in/right-out movements. Of note, implementing protective-permissive left turn phasing on the westbound approach of the North Spectrum Loop and Voyager Parkway (#3) intersection could be considered to help reduce vehicle queues. It should be noted that project traffic is anticipated to contribute 18 of the 187 (9.6 percent) peak hour westbound left turn movements at the North Spectrum Loop and Voyager Parkway intersection in 2024.

By 2045, dual westbound left turn lanes may be needed at the intersection of North Gate Boulevard and Voyager Parkway (#1) to accommodate the anticipated vehicle queues. The area for these dual left turn lanes is presently available and will only require restriping as the space for the second turn lane is currently striped out. Of note, project traffic is anticipated to contribute ten (10) of the 338 (2.9 percent) peak hour westbound left turn movements at the North Gate Boulevard and Voyager Parkway intersection in 2024 (and 1.7 percent in 2045).

The northbound left turn lane at the intersection of Powers Boulevard On-Ramp and Voyager Parkway (#5) is calculated to extend beyond the available storage by 2045. However, the Powers Boulevard Off-Ramp and Voyager Parkway (#6) intersection provides 300 feet of external stacking (for a total of approximately 550 feet) for the northbound left turn movements at the Powers Boulevard On-Ramp and Voyager Parkway (#5) intersection. Therefore, vehicle queues are expected to be contained in 2045 with this external stacking at the Off-Ramp intersection. Of note, project traffic is not anticipated to contribute to this movement.

5.4 Improvement Summary

Based on the results of the intersection operational and vehicle queuing analysis, the key intersection recommended improvements and control are shown in **Figure 10** for 2024 and **Figure 11** for 2045. As referenced previously, two conceptual improvement exhibits are provided in **Appendix G** for the two access scenarios at the North Spectrum Loop West Access (#8).

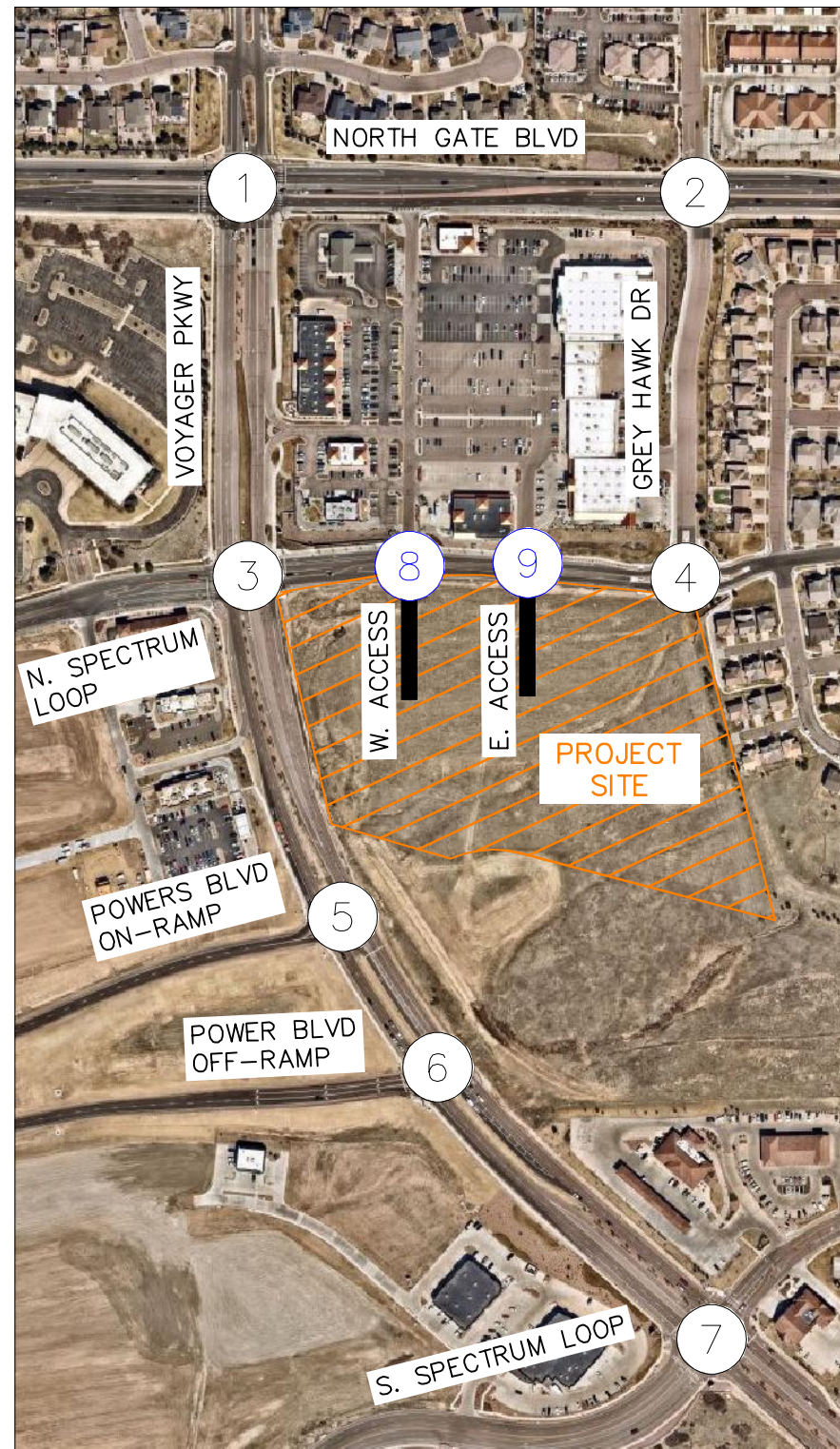

SPECTRUM AND VOYAGER
 COLORADO SPRINGS, COLORADO
 2024 RECOMMENDED GEOMETRY AND CONTROL

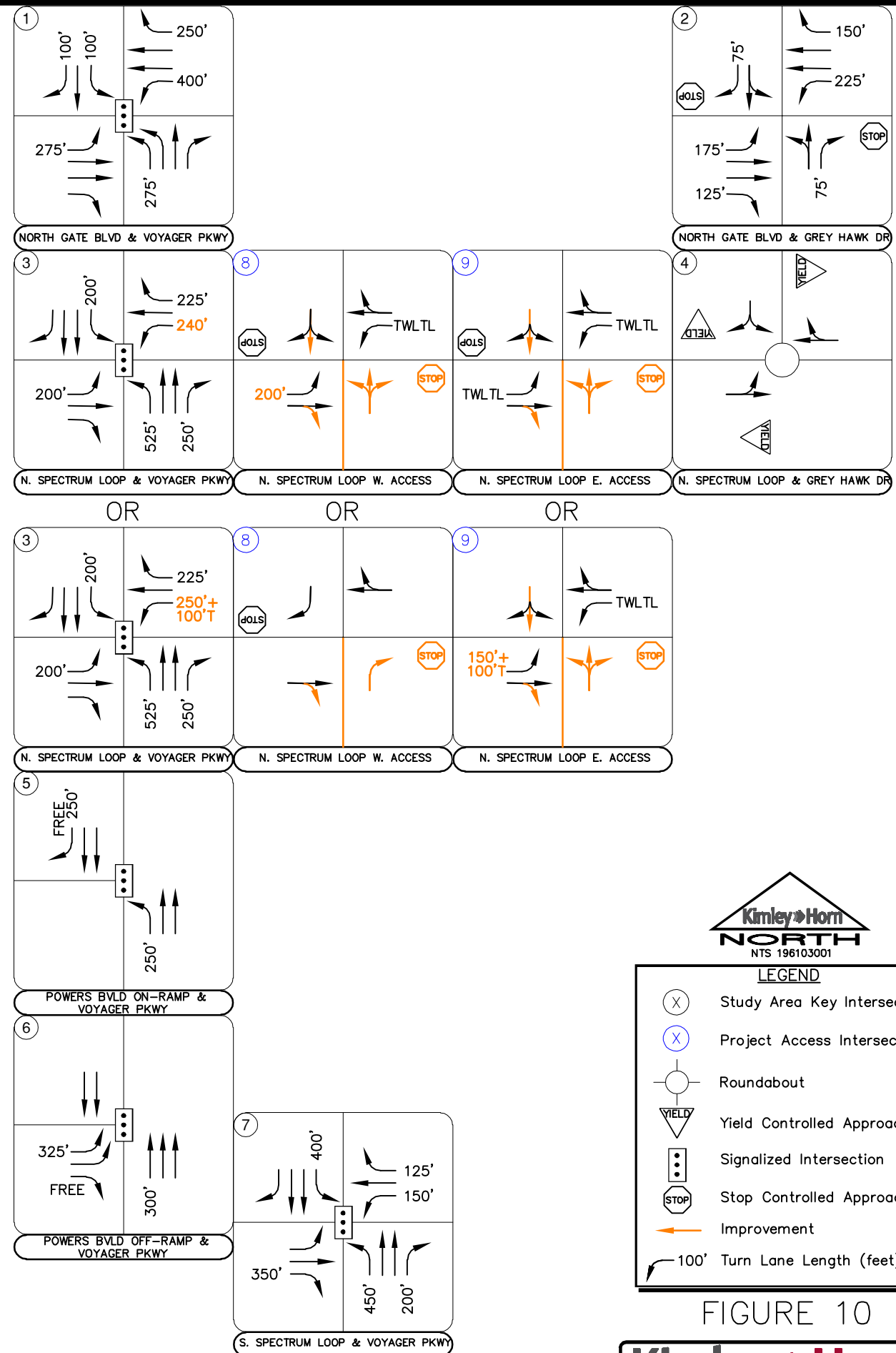
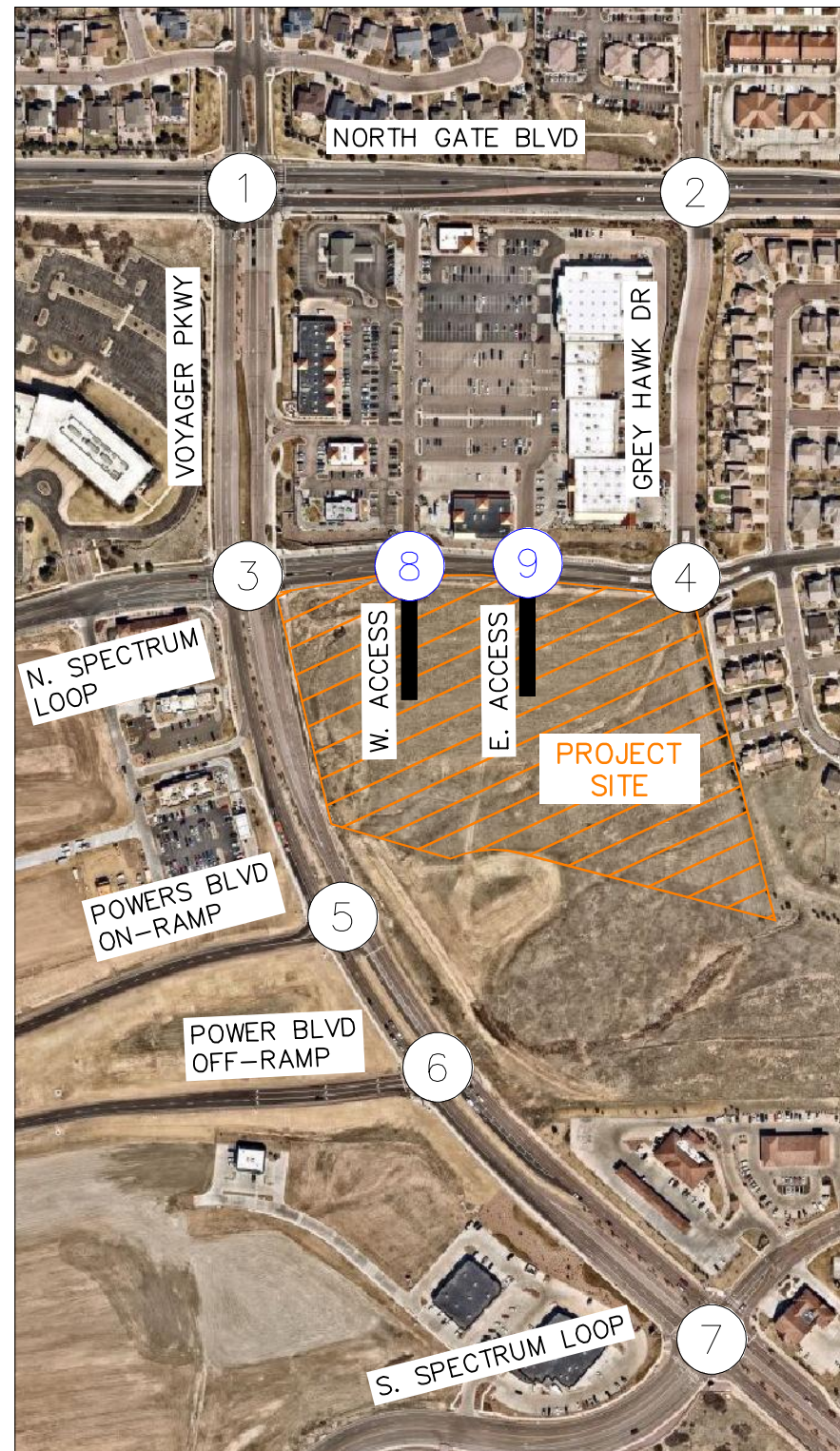
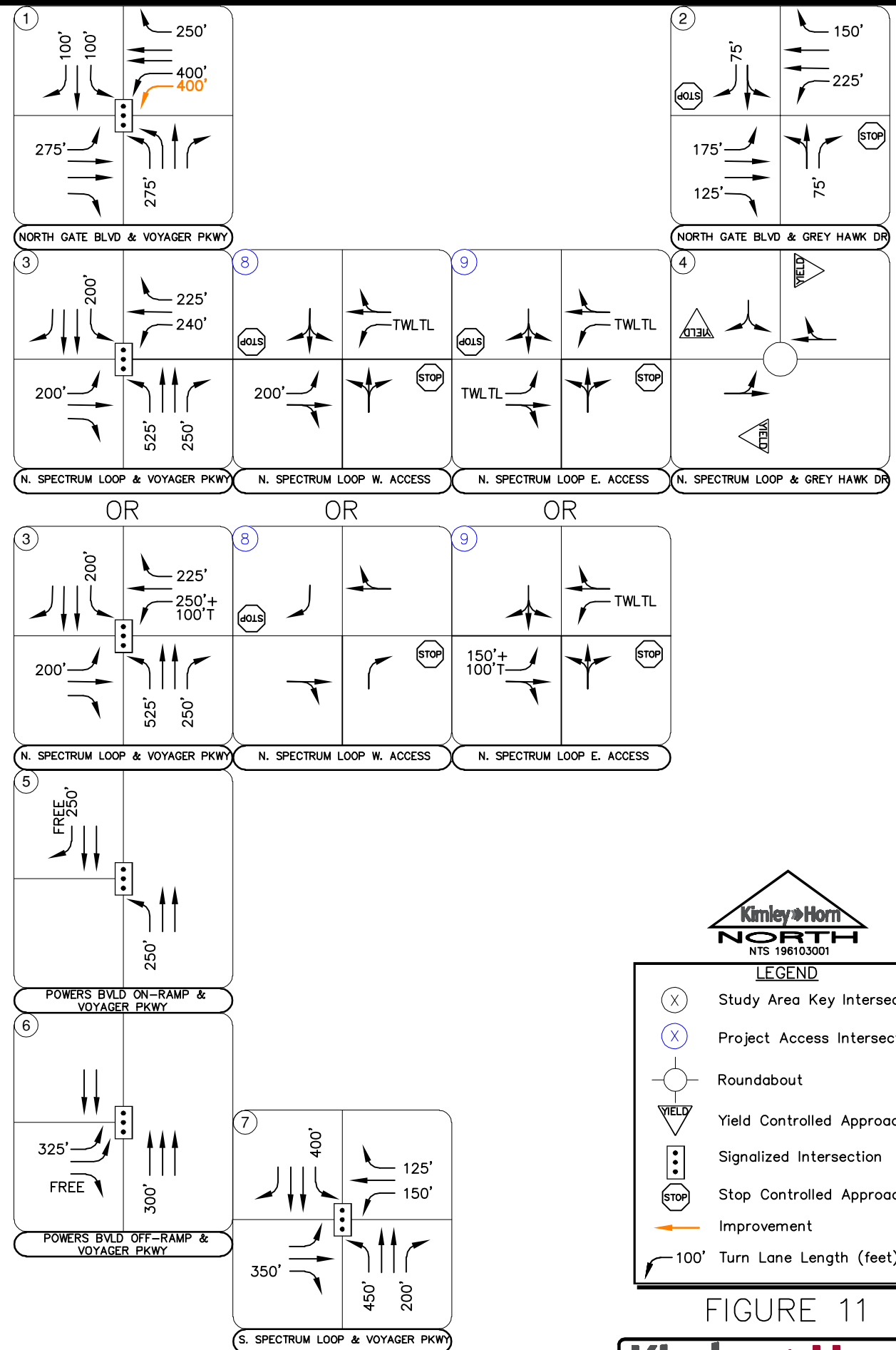

FIGURE 10





SPECTRUM AND VOYAGER
 COLORADO SPRINGS, COLORADO
 2045 RECOMMENDED GEOMETRY AND CONTROL



Kimley-Horn
 NORTH
 NTS 196103001

LEGEND

- (X) Study Area Key Intersection
- (X) Project Access Intersection
- Roundabout
- ▽ YIELD
- ⋮ Signalized Intersection
- ⊠ STOP
- Improvement
- ↩ 100' Turn Lane Length (feet)

FIGURE 11

6.0 CONCLUSIONS AND RECOMMENDATIONS

Based on the analysis presented in this report, Kimley-Horn believes the Spectrum and Voyager project will be successfully incorporated into the existing and future roadway network. Analysis of the existing street network, the proposed project development, and expected traffic volumes resulted in the following conclusions and recommendations:

2024 Recommendations:

- With completion of the Spectrum and Voyager project, two project accesses are proposed along the south side of North Spectrum Loop. The west access (#8) and the east access (#9) both will align with existing full movement accesses to the retail center to the north. It is recommended that a R1-1 “STOP” sign be installed on the exiting northbound approaches of both accesses. A single exiting lane for all movements should be sufficient at both accesses. The North Spectrum Loop East Access (#9) should operate as a full movement access. The North Spectrum Loop West Access (#8) could operate as a full movement access or a right-in/right-out access. With a full movement access at the North Spectrum Loop West Access (#9), the two-way left turn lane that is currently striped at both proposed accesses will provide left turn movements for entering the proposed development. If the North Spectrum Loop West Access (#9) were restricted to right-in/right-out movements due to long vehicle queues, a raised center median would be constructed along Spectrum Loop to restrict left turning movements at this access.
- It is recommended that the northbound and southbound left turn phasing at the intersection of North Spectrum Loop and Voyager Parkway (#3) be changed to protected-permissive in order to provide acceptable operations. It should be noted that the westbound left turn lane at the intersection of North Spectrum Loop and Voyager Parkway (#3) is anticipated to exceed the available storage. If the North Spectrum Loop West Access (#8) remains a full movement access, it is recommended that the westbound left turn lane at the intersection of North Spectrum Loop and Voyager Parkway (#3) be designated to a maximum length of 240 feet. This would require the eastbound left turn lane at the North Spectrum Loop West Access (#8) to be side by side with the westbound left turn lane at the intersection of North Spectrum Loop and Voyager Parkway (#3) and designated to a length of 200 feet. If the North Spectrum Loop West Access (#8) were restricted to right turn movements only, it is recommended that the

westbound left turn lane at the intersection of North Spectrum Loop and Voyager Parkway (#3) be designated to a maximum length of 250 feet with a 100-foot taper. This 100-foot taper would be shared with the eastbound left turn lane at the North Spectrum Loop East Access (#9) which would be designated to a maximum length of 150 feet. A conceptual improvement exhibit is attached in **Appendix G** for the side-by-side left turn lane configuration with the scenario of the west access remaining full turning movements. Likewise, a conceptual improvement exhibit is also attached in **Appendix G** with the scenario of the west access being a restricted to right-in/right-out movements. Of note, implementing protective-permissive left turn phasing on the westbound approach of the North Spectrum Loop and Voyager Parkway (#3) intersection could be considered to help reduce vehicle queues.

2045 Recommendations:

- By 2045, dual westbound left turn lanes may be needed at the intersection of North Gate Boulevard and Voyager Parkway (#1). The area for these dual left turn lanes is presently available and will only require restriping as the space for the second turn lane is currently striped out.

General Recommendations:

- Any on-site or offsite improvements should be incorporated into the Civil Drawings and conform to standards of the City of Colorado Springs and the Manual on Uniform Traffic Control Devices (MUTCD) – 2009 Edition.

APPENDICES

APPENDIX A

Intersection Count Sheets/Street Light Traffic Data



Ridgeview Data
Collection

Colorado Springs, CO
Voyager and Spectrum Multifamily
AM Peak
N Gate Blvd & Voyager Pkwy

File Name : N Gate and Voyager AM
Site Code : IPO 587
Start Date : 1/26/2022
Page No : 1

Groups Printed- Automobiles - Bicycle and Pedestrian

Start Time	N Gate Blvd Eastbound					N Gate Blvd Westbound					Voyager Pkwy Northbound					Voyager Pkwy Southbound					Int. Total
	Left	Thru	Right	Peds	App. Total	Left	Thru	Right	Peds	App. Total	Left	Thru	Right	Peds	App. Total	Left	Thru	Right	Peds	App. Total	
07:00 AM	1	45	23	0	69	41	69	1	0	111	15	4	9	0	28	5	10	12	0	27	235
07:15 AM	0	69	44	0	113	75	94	4	0	173	25	1	43	0	69	20	23	8	0	51	406
07:30 AM	1	90	45	0	136	89	104	4	0	197	46	4	52	0	102	13	18	10	0	41	476
07:45 AM	3	79	44	0	126	87	112	2	0	201	25	9	50	0	84	14	22	15	0	51	462
Total	5	283	156	0	444	292	379	11	0	682	111	18	154	0	283	52	73	45	0	170	1579
08:00 AM	4	67	35	0	106	73	113	4	0	190	54	11	36	0	101	7	17	8	0	32	429
08:15 AM	4	37	28	0	69	60	102	3	1	166	32	6	14	0	52	3	12	7	0	22	309
08:30 AM	2	50	27	0	79	29	75	2	0	106	37	6	26	0	69	2	9	7	0	18	272
08:45 AM	2	80	42	0	124	25	67	2	0	94	38	6	21	0	65	2	10	10	0	22	305
Total	12	234	132	0	378	187	357	11	1	556	161	29	97	0	287	14	48	32	0	94	1315
Grand Total	17	517	288	0	822	479	736	22	1	1238	272	47	251	0	570	66	121	77	0	264	2894
Apprch %	2.1	62.9	35	0		38.7	59.5	1.8	0.1		47.7	8.2	44	0		25	45.8	29.2	0		
Total %	0.6	17.9	10	0	28.4	16.6	25.4	0.8	0	42.8	9.4	1.6	8.7	0	19.7	2.3	4.2	2.7	0	9.1	
Automobiles	17	517	288	0	822	479	736	22	0	1237	272	47	251	0	570	66	121	77	0	264	2893
% Automobiles	100	100	100	0	100	100	100	100	0	99.9	100	100	100	0	100	100	100	100	0	100	100
Bicycle and Pedestrian	0	0	0	0	0	0	0	0	1	1	0	0	0	0	0	0	0	0	0	0	1
% Bicycle and Pedestrian	0	0	0	0	0	0	0	0	100	0.1	0	0	0	0	0	0	0	0	0	0	0



Ridgeview Data
Collection

Colorado Springs, CO
Voyager and Spectrum Multifamily
AM Peak
N Gate Blvd & Voyager Pkwy

File Name : N Gate and Voyager AM
Site Code : IPO 587
Start Date : 1/26/2022
Page No : 2

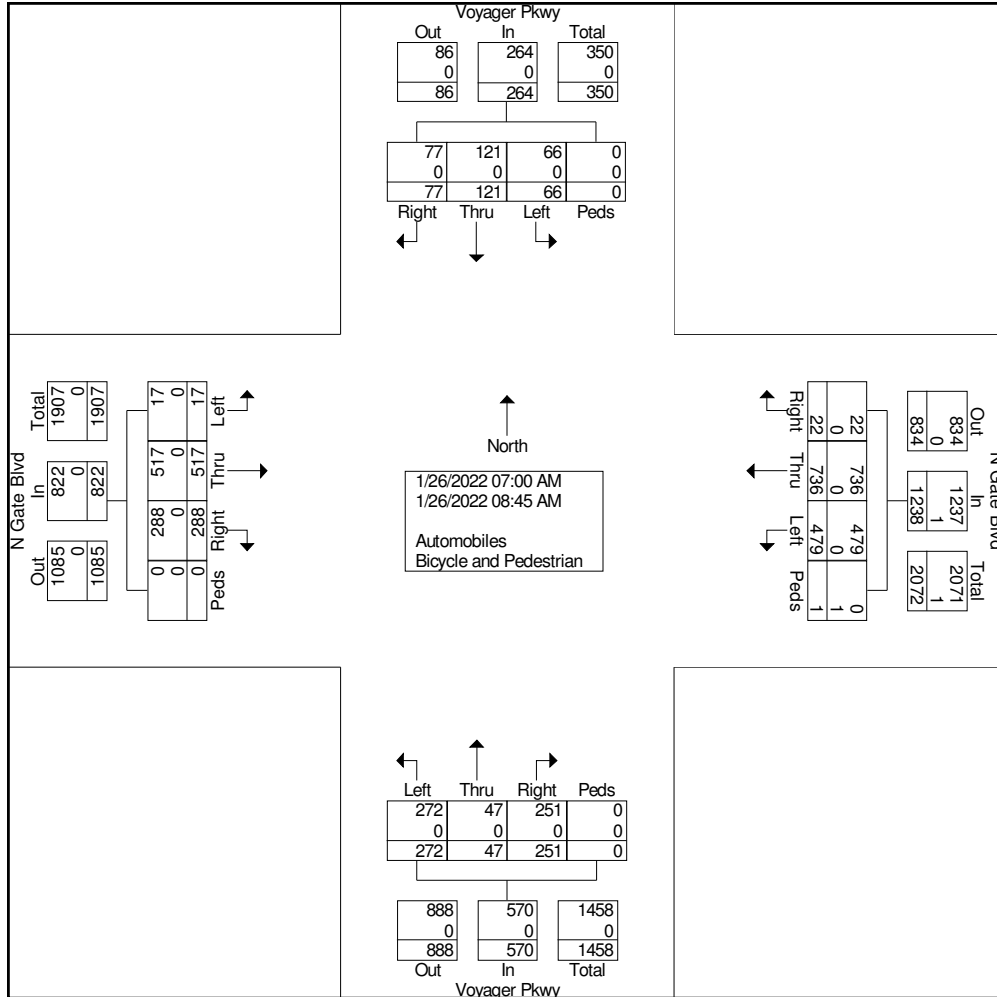



Ridgeview Data
Collection

Colorado Springs, CO
Voyager and Spectrum Multifamily
AM Peak
N Gate Blvd & Voyager Pkwy

File Name : N Gate and Voyager AM
Site Code : IPO 587
Start Date : 1/26/2022
Page No : 3

Start Time	N Gate Blvd Eastbound					N Gate Blvd Westbound					Voyager Pkwy Northbound					Voyager Pkwy Southbound					Int. Total
	Left	Thru	Right	Peds	App. Total	Left	Thru	Right	Peds	App. Total	Left	Thru	Right	Peds	App. Total	Left	Thru	Right	Peds	App. Total	
Peak Hour Analysis From 07:00 AM to 08:45 AM - Peak 1 of 1																					
Peak Hour for Entire Intersection Begins at 07:15 AM																					
07:15 AM	0	69	44	0	113	75	94	4	0	173	25	1	43	0	69	20	23	8	0	51	406
07:30 AM	1	90	45	0	136	89	104	4	0	197	46	4	52	0	102	13	18	10	0	41	476
07:45 AM	3	79	44	0	126	87	112	2	0	201	25	9	50	0	84	14	22	15	0	51	462
08:00 AM	4	67	35	0	106	73	113	4	0	190	54	11	36	0	101	7	17	8	0	32	429
Total Volume	8	305	168	0	481	324	423	14	0	761	150	25	181	0	356	54	80	41	0	175	1773
% App. Total	1.7	63.4	34.9	0		42.6	55.6	1.8	0		42.1	7	50.8	0		30.9	45.7	23.4	0		
PHF	.500	.847	.933	.000	.884	.910	.936	.875	.000	.947	.694	.568	.870	.000	.873	.675	.870	.683	.000	.858	.931

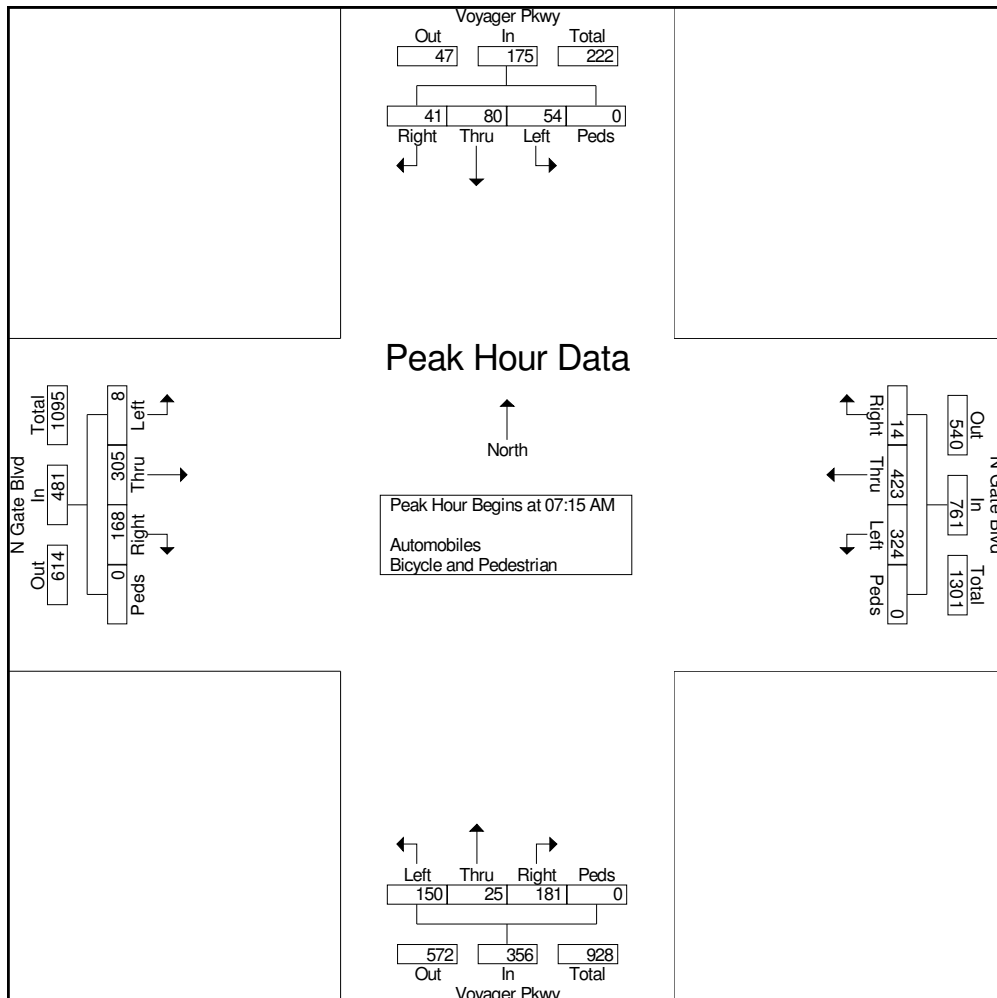

Voyager Pkwy North Gate Blvd



Peak Hour

Date: 08/25/2022
Count Period: 2:00 PM to 4:00 PM
Peak Hour: 3:00 PM to 4:00 PM

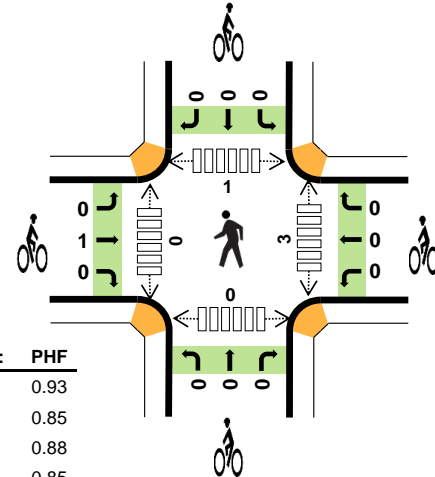
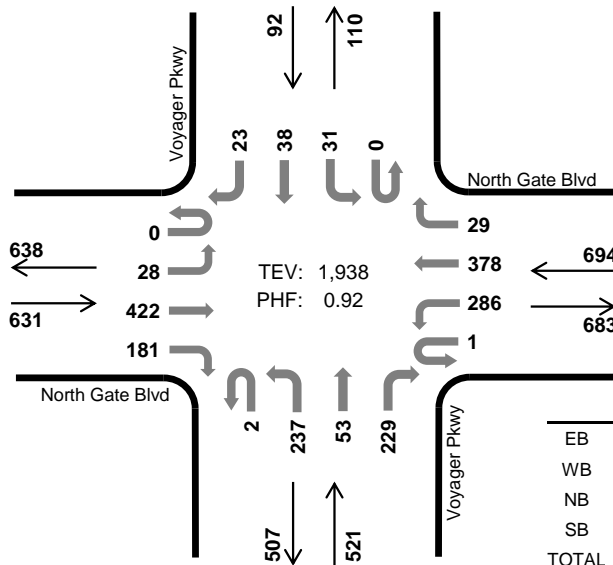

	HV %:	PHF
EB	1.3%	0.93
WB	2.6%	0.85
NB	1.0%	0.88
SB	5.4%	0.85
TOTAL	1.9%	0.92

Two-Hour Count Summaries

Interval Start	North Gate Blvd Eastbound				North Gate Blvd Westbound				Voyager Pkwy Northbound				Voyager Pkwy Southbound				15-min Total	Rolling One Hour	
	UT	LT	TH	RT	UT	LT	TH	RT	UT	LT	TH	RT	UT	LT	TH	RT			
2:00 PM	0	5	65	40	0	44	54	3	0	56	9	31	0	5	6	6	324	0	
2:15 PM	0	6	93	42	0	46	57	4	0	51	9	40	0	6	15	5	374	0	
2:30 PM	0	5	90	42	0	45	66	5	0	36	12	45	0	7	10	8	371	0	
2:45 PM	0	6	95	43	1	64	71	5	0	50	12	49	0	8	5	9	418	1,487	
3:00 PM	0	5	106	59	0	83	108	13	0	55	9	63	0	7	10	8	526	1,689	
3:15 PM	0	9	108	30	1	73	84	2	0	61	14	73	0	11	6	2	474	1,789	
3:30 PM	0	10	93	48	0	81	104	6	1	67	13	47	0	9	13	5	497	1,915	
3:45 PM	0	4	115	44	0	49	82	8	1	54	17	46	0	4	9	8	441	1,938	
Count Total	0	50	765	348	2	485	626	46	2	430	95	394	0	57	74	51	3,425	0	
Peak Hour	All	0	28	422	181	1	286	378	29	2	237	53	229	0	31	38	23	1,938	0
	HV	0	0	5	3	0	4	11	3	0	2	0	3	0	2	1	2	36	0
	HV%	-	0%	1%	2%	0%	1%	3%	10%	0%	1%	0%	1%	-	6%	3%	9%	2%	0

Note: Two-hour count summary volumes include heavy vehicles but exclude bicycles in overall count.

Interval Start	Heavy Vehicle Totals					Bicycles					Pedestrians (Crossing Leg)				
	EB	WB	NB	SB	Total	EB	WB	NB	SB	Total	East	West	North	South	Total
2:00 PM	2	6	0	0	8	0	0	0	0	0	0	0	0	0	0
2:15 PM	2	1	3	0	6	0	0	0	0	0	0	0	2	1	3
2:30 PM	0	5	1	0	6	0	0	0	0	0	0	0	0	0	0
2:45 PM	2	1	1	0	4	0	1	0	0	1	0	0	0	0	1
3:00 PM	3	6	0	2	11	1	0	0	0	1	0	0	0	0	0
3:15 PM	2	2	3	0	7	0	0	0	0	0	1	0	1	0	2
3:30 PM	1	8	2	3	14	0	0	0	0	0	1	0	0	0	1
3:45 PM	2	2	0	0	4	0	0	0	0	0	1	0	0	0	1
Count Total	14	31	10	5	60	1	1	0	0	2	3	0	3	2	8
Peak Hour	8	18	5	5	36	1	0	0	0	1	3	0	1	0	4

Two-Hour Count Summaries - Heavy Vehicles																		
Interval Start	North Gate Blvd				North Gate Blvd				Voyager Pkwy				Voyager Pkwy				15-min Total	Rolling One Hour
	Eastbound				Westbound				Northbound				Southbound					
	UT	LT	TH	RT	UT	LT	TH	RT	UT	LT	TH	RT	UT	LT	TH	RT		
2:00 PM	0	0	2	0	0	4	2	0	0	0	0	0	0	0	0	0	8	0
2:15 PM	0	0	2	0	0	0	1	0	0	3	0	0	0	0	0	0	6	0
2:30 PM	0	0	0	0	0	0	4	1	0	0	0	0	1	0	0	0	6	0
2:45 PM	0	0	2	0	0	0	1	0	0	0	1	0	0	0	0	0	4	24
3:00 PM	0	0	3	0	0	1	3	2	0	0	0	0	0	0	0	2	11	27
3:15 PM	0	0	1	1	0	1	0	1	0	0	0	3	0	0	0	0	7	28
3:30 PM	0	0	0	1	0	2	6	0	0	2	0	0	0	2	1	0	14	36
3:45 PM	0	0	1	1	0	0	2	0	0	0	0	0	0	0	0	0	4	36
Count Total	0	0	11	3	0	8	19	4	0	5	1	4	0	2	1	2	60	0
Peak Hour	0	0	5	3	0	4	11	3	0	2	0	3	0	2	1	2	36	0
Two-Hour Count Summaries - Bikes																		
Interval Start	North Gate Blvd			North Gate Blvd			Voyager Pkwy			Voyager Pkwy			15-min Total	Rolling One Hour				
	Eastbound			Westbound			Northbound			Southbound								
	LT	TH	RT	LT	TH	RT	LT	TH	RT	LT	TH	RT						
2:00 PM	0	0	0	0	0	0	0	0	0	0	0	0	0	0	0	0	0	0
2:15 PM	0	0	0	0	0	0	0	0	0	0	0	0	0	0	0	0	0	0
2:30 PM	0	0	0	0	0	0	0	0	0	0	0	0	0	0	0	0	0	0
2:45 PM	0	0	0	0	0	1	0	0	0	0	0	0	0	0	0	0	1	1
3:00 PM	0	1	0	0	0	0	0	0	0	0	0	0	0	0	0	0	1	2
3:15 PM	0	0	0	0	0	0	0	0	0	0	0	0	0	0	0	0	0	2
3:30 PM	0	0	0	0	0	0	0	0	0	0	0	0	0	0	0	0	0	2
3:45 PM	0	0	0	0	0	0	0	0	0	0	0	0	0	0	0	0	0	1
Count Total	0	1	0	0	0	1	0	0	0	0	0	0	0	0	0	0	2	0
Peak Hour	0	1	0	0	0	0	0	0	0	0	0	0	0	0	0	0	1	0
<i>Note: U-Turn volumes for bikes are included in Left-Turn, if any.</i>																		



Colorado Springs, CO
 Voyager and Spectrum Multifamily
 PM Peak
 N Gate Blvd & Voyager Pkwy

File Name : N Gate and Voyager PM
 Site Code : IPO 587
 Start Date : 1/26/2022
 Page No : 1

Groups Printed- Automobiles - Bicycle and Pedestrian

Start Time	N Gate Blvd Eastbound					N Gate Blvd Westbound					Voyager Pkwy Northbound					Voyager Pkwy Southbound					Int. Total
	Left	Thru	Right	Peds	App. Total	Left	Thru	Right	Peds	App. Total	Left	Thru	Right	Peds	App. Total	Left	Thru	Right	Peds	App. Total	
04:00 PM	8	116	61	0	185	34	57	7	0	98	67	18	38	0	123	5	11	6	0	22	428
04:15 PM	8	124	53	0	185	53	75	10	0	138	60	12	37	0	109	8	8	14	0	30	462
04:30 PM	8	112	65	0	185	39	72	7	0	118	59	18	48	4	129	7	3	6	0	16	448
04:45 PM	7	123	49	1	180	49	95	6	1	151	50	15	41	0	106	8	12	6	0	26	463
Total	31	475	228	1	735	175	299	30	1	505	236	63	164	4	467	28	34	32	0	94	1801
05:00 PM	12	108	53	0	173	46	78	9	0	133	77	12	48	0	137	5	9	6	1	21	464
05:15 PM	9	144	48	0	201	35	98	4	1	138	58	12	54	4	128	5	6	9	1	21	488
05:30 PM	6	123	56	0	185	45	72	6	0	123	73	18	44	0	135	4	11	7	0	22	465
05:45 PM	12	103	47	0	162	28	61	8	0	97	55	8	41	0	104	3	13	8	0	24	387
Total	39	478	204	0	721	154	309	27	1	491	263	50	187	4	504	17	39	30	2	88	1804
Grand Total	70	953	432	1	1456	329	608	57	2	996	499	113	351	8	971	45	73	62	2	182	3605
Apprch %	4.8	65.5	29.7	0.1		33	61	5.7	0.2		51.4	11.6	36.1	0.8		24.7	40.1	34.1	1.1		
Total %	1.9	26.4	12	0	40.4	9.1	16.9	1.6	0.1	27.6	13.8	3.1	9.7	0.2	26.9	1.2	2	1.7	0.1	5	
Automobiles	70	952	432	0	1454	329	608	57	0	994	499	113	351	0	963	45	73	62	0	180	3591
% Automobiles	100	99.9	100	0	99.9	100	100	100	0	99.8	100	100	100	0	99.2	100	100	100	0	98.9	99.6
Bicycle and Pedestrian	0	1	0	1	2	0	0	0	2	2	0	0	0	8	8	0	0	0	2	2	14
% Bicycle and Pedestrian	0	0.1	0	100	0.1	0	0	0	100	0.2	0	0	0	100	0.8	0	0	0	100	1.1	0.4



Ridgeview Data
Collection

Colorado Springs, CO
Voyager and Spectrum Multifamily
PM Peak
N Gate Blvd & Voyager Pkwy

File Name : N Gate and Voyager PM
Site Code : IPO 587
Start Date : 1/26/2022
Page No : 2

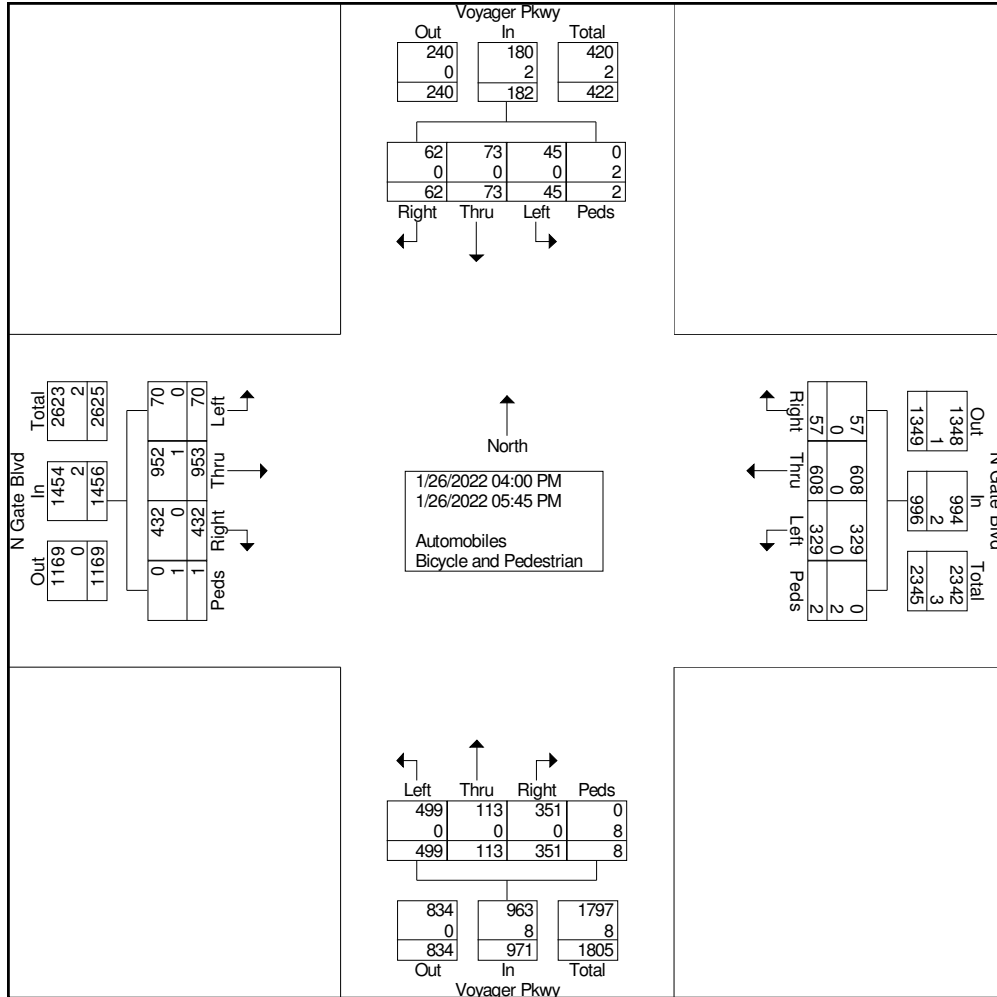



Ridgeview Data
Collection

Colorado Springs, CO
Voyager and Spectrum Multifamily
PM Peak
N Gate Blvd & Voyager Pkwy

File Name : N Gate and Voyager PM
Site Code : IPO 587
Start Date : 1/26/2022
Page No : 3

Start Time	N Gate Blvd Eastbound					N Gate Blvd Westbound					Voyager Pkwy Northbound					Voyager Pkwy Southbound					Int. Total
	Left	Thru	Right	Peds	App. Total	Left	Thru	Right	Peds	App. Total	Left	Thru	Right	Peds	App. Total	Left	Thru	Right	Peds	App. Total	
Peak Hour Analysis From 04:00 PM to 05:45 PM - Peak 1 of 1																					
Peak Hour for Entire Intersection Begins at 04:45 PM																					
04:45 PM	7	123	49	1	180	49	95	6	1	151	50	15	41	0	106	8	12	6	0	26	463
05:00 PM	12	108	53	0	173	46	78	9	0	133	77	12	48	0	137	5	9	6	1	21	464
05:15 PM	9	144	48	0	201	35	98	4	1	138	58	12	54	4	128	5	6	9	1	21	488
05:30 PM	6	123	56	0	185	45	72	6	0	123	73	18	44	0	135	4	11	7	0	22	465
Total Volume	34	498	206	1	739	175	343	25	2	545	258	57	187	4	506	22	38	28	2	90	1880
% App. Total	4.6	67.4	27.9	0.1		32.1	62.9	4.6	0.4		51	11.3	37	0.8		24.4	42.2	31.1	2.2		
PHF	.708	.865	.920	.250	.919	.893	.875	.694	.500	.902	.838	.792	.866	.250	.923	.688	.792	.778	.500	.865	.963

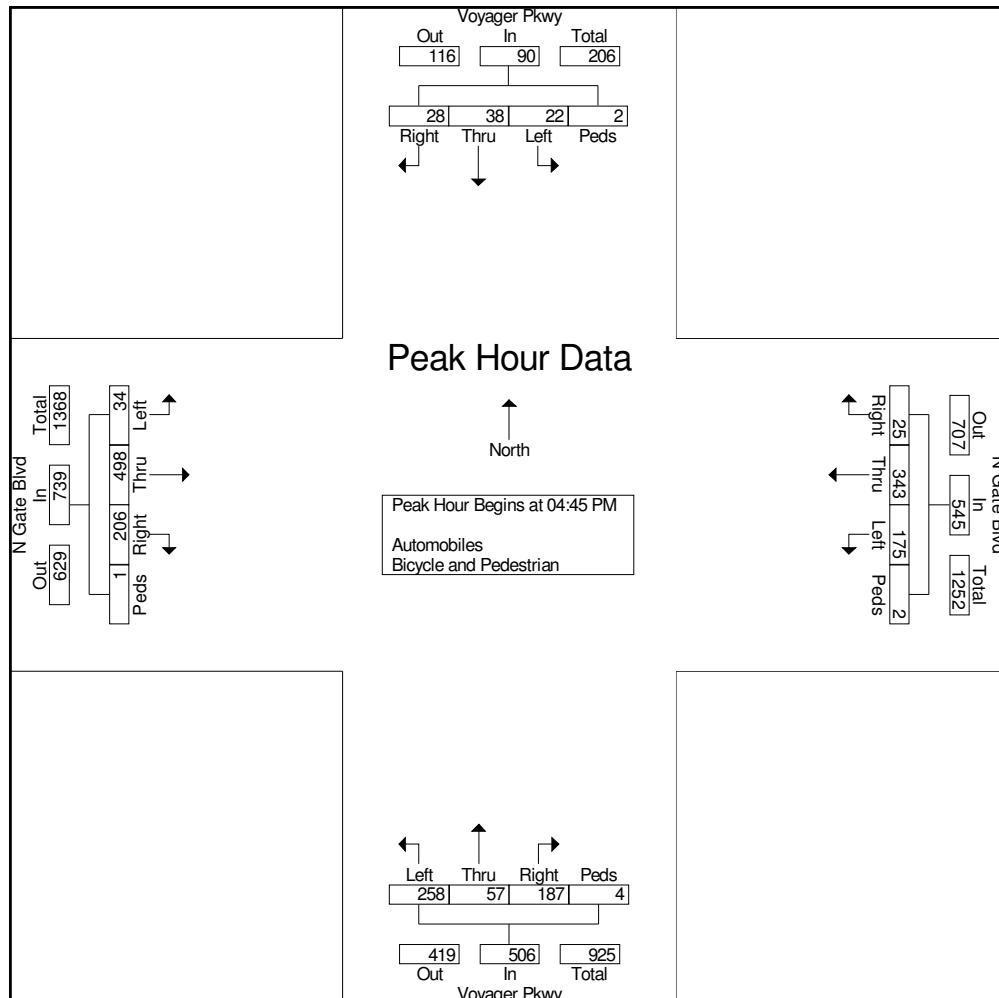



Colorado Springs, CO
 Voyager and Spectrum Multifamily
 AM Peak
 N Gate Blvd & Grey Hawk Dr

File Name : N Gate and Grey Hawk AM
 Site Code : IPO 587
 Start Date : 1/26/2022
 Page No : 1

Groups Printed- Automobiles - Bicycle and Pedestrian

Start Time	N Gate Blvd Eastbound					N Gate Blvd Westbound					Grey Hawk Dr Northbound					Northgate Estates Dr Southbound					Int. Total
	Left	Thru	Right	Peds	App. Total	Left	Thru	Right	Peds	App. Total	Left	Thru	Right	Peds	App. Total	Left	Thru	Right	Peds	App. Total	
07:00 AM	1	57	1	0	59	0	98	4	0	102	1	0	3	0	4	4	0	5	0	9	174
07:15 AM	3	123	0	0	126	2	155	3	0	160	2	0	7	1	10	4	0	13	0	17	313
07:30 AM	13	139	2	0	154	7	188	13	0	208	2	0	1	0	3	3	0	11	0	14	379
07:45 AM	18	121	1	0	140	9	193	13	0	215	1	0	1	1	3	4	1	6	0	11	369
Total	35	440	4	0	479	18	634	33	0	685	6	0	12	2	20	15	1	35	0	51	1235
08:00 AM	8	113	2	0	123	9	187	6	0	202	2	0	2	0	4	2	0	4	0	6	335
08:15 AM	10	39	2	0	51	7	150	6	0	163	0	0	1	0	1	1	0	7	0	8	223
08:30 AM	15	64	1	0	80	3	106	4	0	113	0	1	1	0	2	2	0	7	0	9	204
08:45 AM	17	74	4	0	95	16	81	13	0	110	0	0	5	0	5	11	0	14	0	25	235
Total	50	290	9	0	349	35	524	29	0	588	2	1	9	0	12	16	0	32	0	48	997
Grand Total	85	730	13	0	828	53	1158	62	0	1273	8	1	21	2	32	31	1	67	0	99	2232
Apprch %	10.3	88.2	1.6	0		4.2	91	4.9	0		25	3.1	65.6	6.2		31.3	1	67.7	0		
Total %	3.8	32.7	0.6	0	37.1	2.4	51.9	2.8	0	57	0.4	0	0.9	0.1	1.4	1.4	0	3	0	4.4	
Automobiles	85	730	13	0	828	53	1158	62	0	1273	8	1	21	0	30	31	1	67	0	99	2230
% Automobiles	100	100	100	0	100	100	100	100	0	100	100	100	100	0	93.8	100	100	100	0	100	99.9
Bicycle and Pedestrian	0	0	0	0	0	0	0	0	0	0	0	0	0	2	2	0	0	0	0	0	2
% Bicycle and Pedestrian	0	0	0	0	0	0	0	0	0	0	0	0	0	100	6.2	0	0	0	0	0	0.1



Ridgeview Data
Collection

Colorado Springs, CO
Voyager and Spectrum Multifamily
AM Peak
N Gate Blvd & Grey Hawk Dr

File Name : N Gate and Grey Hawk AM
Site Code : IPO 587
Start Date : 1/26/2022
Page No : 2

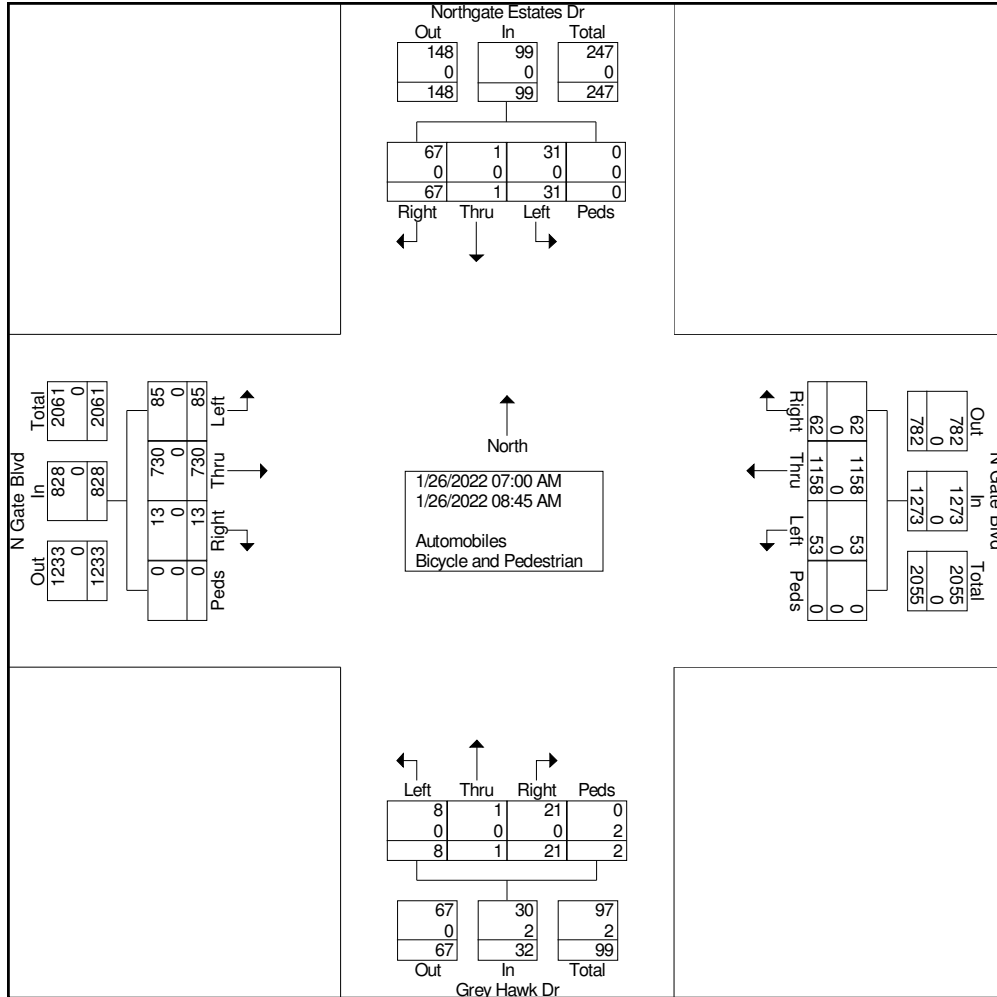



Ridgeview Data
Collection

Colorado Springs, CO
Voyager and Spectrum Multifamily
AM Peak
N Gate Blvd & Grey Hawk Dr

File Name : N Gate and Grey Hawk AM
Site Code : IPO 587
Start Date : 1/26/2022
Page No : 3

Start Time	N Gate Blvd Eastbound					N Gate Blvd Westbound					Grey Hawk Dr Northbound					Northgate Estates Dr Southbound					Int. Total
	Left	Thru	Right	Peds	App. Total	Left	Thru	Right	Peds	App. Total	Left	Thru	Right	Peds	App. Total	Left	Thru	Right	Peds	App. Total	
Peak Hour Analysis From 07:00 AM to 08:45 AM - Peak 1 of 1																					
Peak Hour for Entire Intersection Begins at 07:15 AM																					
07:15 AM	3	123	0	0	126	2	155	3	0	160	2	0	7	1	10	4	0	13	0	17	313
07:30 AM	13	139	2	0	154	7	188	13	0	208	2	0	1	0	3	3	0	11	0	14	379
07:45 AM	18	121	1	0	140	9	193	13	0	215	1	0	1	1	3	4	1	6	0	11	369
08:00 AM	8	113	2	0	123	9	187	6	0	202	2	0	2	0	4	2	0	4	0	6	335
Total Volume	42	496	5	0	543	27	723	35	0	785	7	0	11	2	20	13	1	34	0	48	1396
% App. Total	7.7	91.3	0.9	0		3.4	92.1	4.5	0		35	0	55	10		27.1	2.1	70.8	0		
PHF	.583	.892	.625	.000	.881	.750	.937	.673	.000	.913	.875	.000	.393	.500	.500	.813	.250	.654	.000	.706	.921

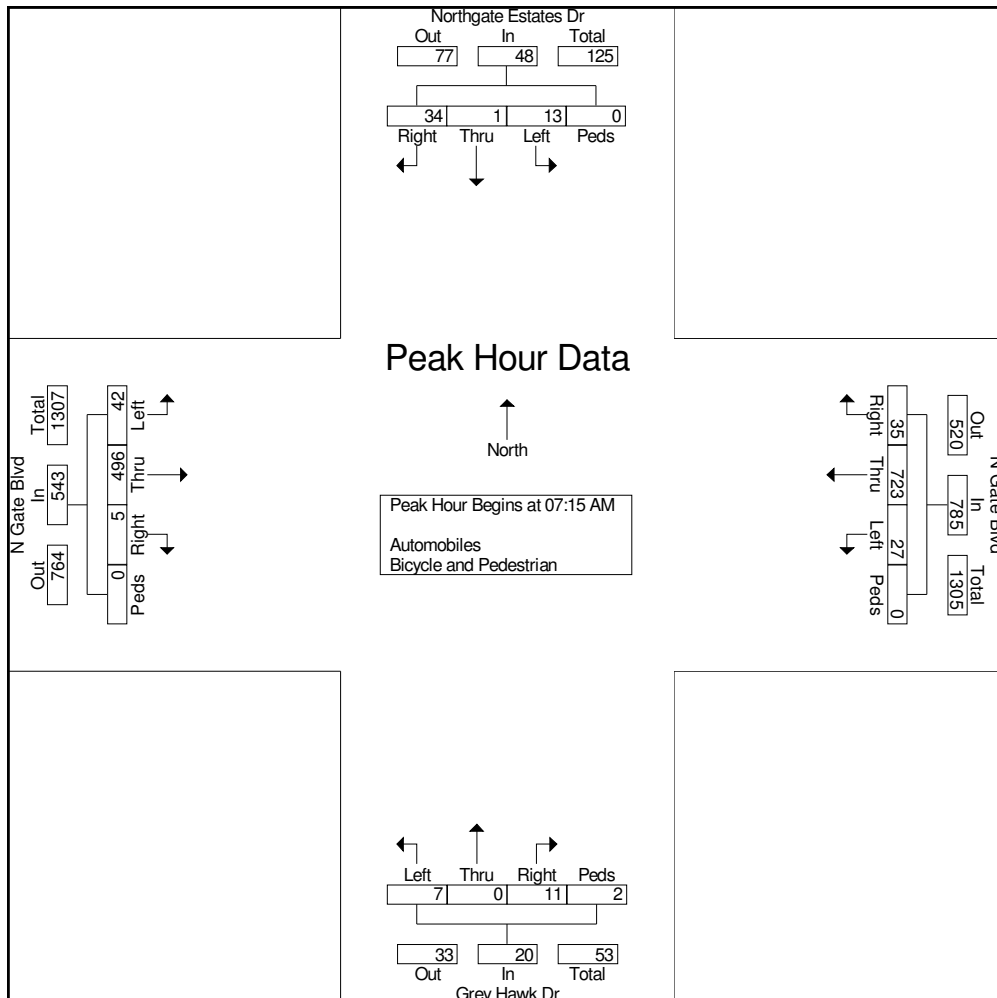

Grey Hawk Dr North Gate Blvd



Peak Hour

Date: 08/25/2022
Count Period: 2:00 PM to 4:00 PM
Peak Hour: 3:00 PM to 4:00 PM

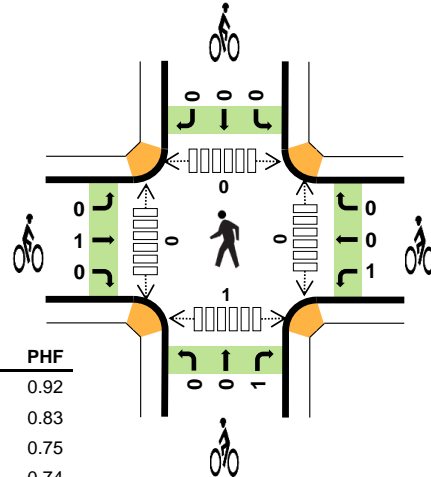
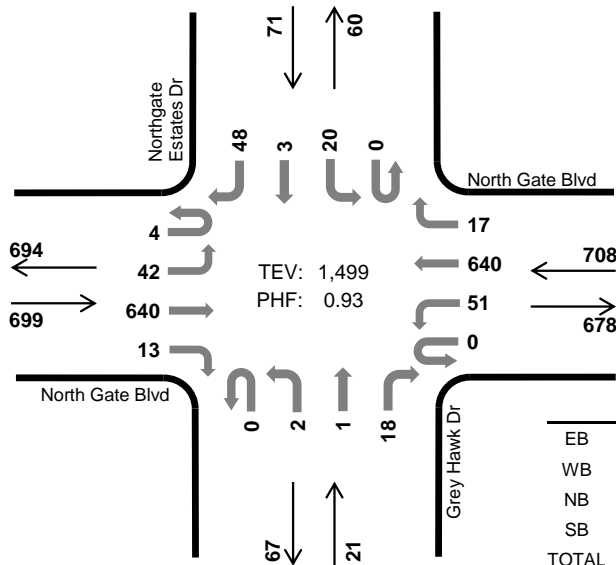

	HV %:	PHF
EB	1.7%	0.92
WB	3.1%	0.83
NB	4.8%	0.75
SB	1.4%	0.74
TOTAL	2.4%	0.93

Two-Hour Count Summaries

Interval Start	North Gate Blvd Eastbound				North Gate Blvd Westbound				Grey Hawk Dr Northbound				Northgate Estates Dr Southbound				15-min Total	Rolling One Hour	
	UT	LT	TH	RT	UT	LT	TH	RT	UT	LT	TH	RT	UT	LT	TH	RT			
2:00 PM	2	8	97	2	0	5	89	4	0	2	0	3	0	4	0	13	229	0	
2:15 PM	0	15	114	0	0	7	88	3	0	1	0	3	0	2	0	13	246	0	
2:30 PM	3	7	132	1	0	7	108	4	0	1	0	2	0	4	2	10	281	0	
2:45 PM	2	6	144	3	0	11	127	3	0	2	0	8	0	6	0	6	318	1,074	
3:00 PM	1	10	160	3	0	13	194	5	0	2	0	3	0	3	0	9	403	1,248	
3:15 PM	1	12	176	1	0	9	143	1	0	0	0	4	0	5	1	18	371	1,373	
3:30 PM	1	8	147	4	0	15	181	6	0	0	1	6	0	5	0	9	383	1,475	
3:45 PM	1	12	157	5	0	14	122	5	0	0	0	5	0	7	2	12	342	1,499	
Count Total	11	78	1,127	19	0	81	1,052	31	0	8	1	34	0	36	5	90	2,573	0	
Peak Hour	All	4	42	640	13	0	51	640	17	0	2	1	18	0	20	3	48	1,499	0
	HV	0	1	11	0	0	2	19	1	0	0	0	1	0	1	0	0	36	0
	HV%	0%	2%	2%	0%	-	4%	3%	6%	-	0%	0%	6%	-	5%	0%	0%	2%	0

Note: Two-hour count summary volumes include heavy vehicles but exclude bicycles in overall count.

Interval Start	Heavy Vehicle Totals					Bicycles					Pedestrians (Crossing Leg)				
	EB	WB	NB	SB	Total	EB	WB	NB	SB	Total	East	West	North	South	Total
2:00 PM	2	5	1	1	9	0	0	0	0	0	0	0	0	0	0
2:15 PM	1	2	0	0	3	0	0	0	0	0	0	0	0	0	0
2:30 PM	1	6	0	1	8	0	1	0	0	1	0	0	0	0	0
2:45 PM	2	1	0	0	3	0	0	0	0	0	0	0	0	0	0
3:00 PM	4	9	0	0	13	1	0	0	0	1	0	0	0	0	0
3:15 PM	5	4	0	1	10	0	0	1	0	1	0	0	0	1	1
3:30 PM	2	8	0	0	10	0	1	0	0	1	0	0	0	0	0
3:45 PM	1	1	1	0	3	0	0	0	0	0	0	0	0	0	0
Count Total	18	36	2	3	59	1	2	1	0	4	0	0	0	1	1
Peak Hour	12	22	1	1	36	1	1	1	0	3	0	0	0	1	1

Two-Hour Count Summaries - Heavy Vehicles																			
Interval Start	North Gate Blvd				North Gate Blvd				Grey Hawk Dr				Northgate Estates Dr				15-min Total	Rolling One Hour	
	Eastbound				Westbound				Northbound				Southbound						
	UT	LT	TH	RT	UT	LT	TH	RT	UT	LT	TH	RT	UT	LT	TH	RT			
2:00 PM	0	0	2	0	0	0	5	0	0	1	0	0	0	0	0	0	1	9	0
2:15 PM	0	0	1	0	0	0	2	0	0	0	0	0	0	0	0	0	0	3	0
2:30 PM	0	0	1	0	0	1	4	1	0	0	0	0	0	0	0	0	1	8	0
2:45 PM	0	0	2	0	0	0	1	0	0	0	0	0	0	0	0	0	0	3	23
3:00 PM	0	1	3	0	0	2	7	0	0	0	0	0	0	0	0	0	13	27	
3:15 PM	0	0	5	0	0	0	4	0	0	0	0	0	0	0	1	0	0	10	34
3:30 PM	0	0	2	0	0	0	7	1	0	0	0	0	0	0	0	0	0	10	36
3:45 PM	0	0	1	0	0	0	1	0	0	0	0	1	0	0	0	0	0	3	36
Count Total	0	1	17	0	0	3	31	2	0	1	0	1	0	1	0	2	59	0	
Peak Hour	0	1	11	0	0	2	19	1	0	0	0	1	0	1	0	0	36	0	
Two-Hour Count Summaries - Bikes																			
Interval Start	North Gate Blvd			North Gate Blvd			Grey Hawk Dr			Northgate Estates Dr			15-min Total	Rolling One Hour					
	Eastbound			Westbound			Northbound			Southbound									
	LT	TH	RT	LT	TH	RT	LT	TH	RT	LT	TH	RT							
2:00 PM	0	0	0	0	0	0	0	0	0	0	0	0	0	0	0	0	0	0	0
2:15 PM	0	0	0	0	0	0	0	0	0	0	0	0	0	0	0	0	0	0	0
2:30 PM	0	0	0	0	0	1	0	0	0	0	0	0	0	0	0	0	1	0	0
2:45 PM	0	0	0	0	0	0	0	0	0	0	0	0	0	0	0	0	0	0	1
3:00 PM	0	1	0	0	0	0	0	0	0	0	0	0	0	0	0	0	1	2	
3:15 PM	0	0	0	0	0	0	0	0	0	0	1	0	0	0	0	0	1	3	3
3:30 PM	0	0	0	0	1	0	0	0	0	0	0	0	0	0	0	0	1	3	3
3:45 PM	0	0	0	0	0	0	0	0	0	0	0	0	0	0	0	0	0	0	3
Count Total	0	1	0	0	1	1	0	0	0	0	1	0	0	0	0	0	4	0	0
Peak Hour	0	1	0	0	1	0	0	0	0	0	1	0	0	0	0	0	3	0	0
<i>Note: U-Turn volumes for bikes are included in Left-Turn, if any.</i>																			



Colorado Springs, CO
 Voyager and Spectrum Multifamily
 PM Peak
 N Gate Blvd & Grey Hawk Dr

File Name : N Gate and Grey Hawk PM
 Site Code : IPO 587
 Start Date : 1/26/2022
 Page No : 1

Groups Printed- Automobiles - Bicycle and Pedestrian

Start Time	N Gate Blvd Eastbound					N Gate Blvd Westbound					Grey Hawk Dr Northbound					Northgate Estates Dr Southbound					Int. Total
	Left	Thru	Right	Peds	App. Total	Left	Thru	Right	Peds	App. Total	Left	Thru	Right	Peds	App. Total	Left	Thru	Right	Peds	App. Total	
04:00 PM	9	153	6	0	168	11	87	6	0	104	1	1	2	1	5	8	1	9	0	18	295
04:15 PM	10	165	2	0	177	15	117	6	0	138	1	0	7	0	8	3	0	16	0	19	342
04:30 PM	10	164	5	0	179	18	106	2	0	126	0	0	8	0	8	3	1	14	0	18	331
04:45 PM	10	168	4	0	182	16	137	3	0	156	0	1	7	3	11	4	1	9	1	15	364
Total	39	650	17	0	706	60	447	17	0	524	2	2	24	4	32	18	3	48	1	70	1332
05:00 PM	9	155	2	0	166	19	107	1	0	127	1	0	6	0	7	8	3	21	1	33	333
05:15 PM	7	183	3	0	193	16	119	4	0	139	4	1	1	1	7	4	1	9	0	14	353
05:30 PM	13	164	3	0	180	12	118	5	0	135	1	0	3	1	5	7	1	11	0	19	339
05:45 PM	11	124	5	1	141	9	91	3	0	103	1	0	5	0	6	6	1	2	0	9	259
Total	40	626	13	1	680	56	435	13	0	504	7	1	15	2	25	25	6	43	1	75	1284
Grand Total	79	1276	30	1	1386	116	882	30	0	1028	9	3	39	6	57	43	9	91	2	145	2616
Apprch %	5.7	92.1	2.2	0.1		11.3	85.8	2.9	0		15.8	5.3	68.4	10.5		29.7	6.2	62.8	1.4		
Total %	3	48.8	1.1	0	53	4.4	33.7	1.1	0	39.3	0.3	0.1	1.5	0.2	2.2	1.6	0.3	3.5	0.1	5.5	
Automobiles	79	1276	30	0	1385	116	882	30	0	1028	9	3	39	0	51	43	9	91	0	143	2607
% Automobiles	100	100	100	0	99.9	100	100	100	0	100	100	100	100	0	89.5	100	100	100	0	98.6	99.7
Bicycle and Pedestrian	0	0	0	1	1	0	0	0	0	0	0	0	0	6	6	0	0	0	2	2	9
% Bicycle and Pedestrian	0	0	0	100	0.1	0	0	0	0	0	0	0	0	100	10.5	0	0	0	100	1.4	0.3



Ridgeview Data
Collection

Colorado Springs, CO
Voyager and Spectrum Multifamily
PM Peak
N Gate Blvd & Grey Hawk Dr

File Name : N Gate and Grey Hawk PM
Site Code : IPO 587
Start Date : 1/26/2022
Page No : 2

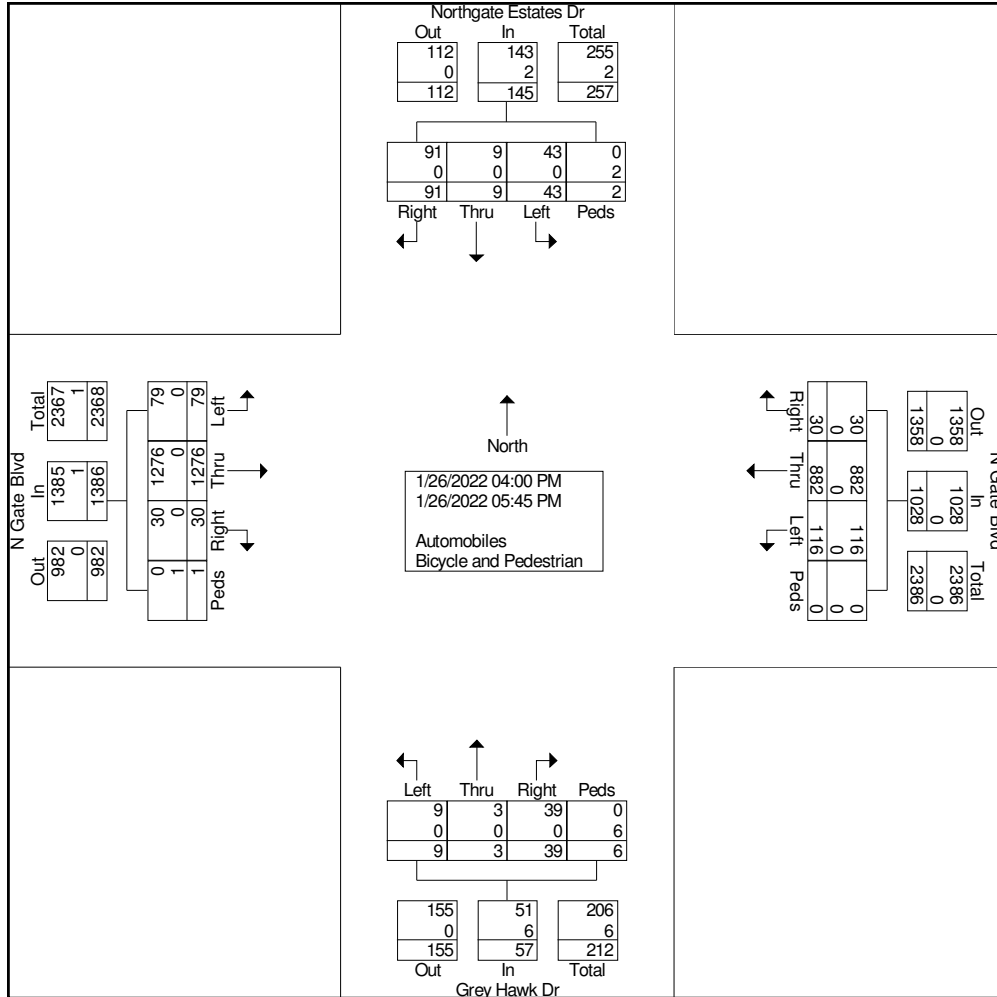



Ridgeview Data
Collection

Colorado Springs, CO
Voyager and Spectrum Multifamily
PM Peak
N Gate Blvd & Grey Hawk Dr

File Name : N Gate and Grey Hawk PM
Site Code : IPO 587
Start Date : 1/26/2022
Page No : 3

Start Time	N Gate Blvd Eastbound					N Gate Blvd Westbound					Grey Hawk Dr Northbound					Northgate Estates Dr Southbound					Int. Total
	Left	Thru	Right	Peds	App. Total	Left	Thru	Right	Peds	App. Total	Left	Thru	Right	Peds	App. Total	Left	Thru	Right	Peds	App. Total	
Peak Hour Analysis From 04:00 PM to 05:45 PM - Peak 1 of 1																					
Peak Hour for Entire Intersection Begins at 04:45 PM																					
04:45 PM	10	168	4	0	182	16	137	3	0	156	0	1	7	3	11	4	1	9	1	15	364
05:00 PM	9	155	2	0	166	19	107	1	0	127	1	0	6	0	7	8	3	21	1	33	333
05:15 PM	7	183	3	0	193	16	119	4	0	139	4	1	1	1	7	4	1	9	0	14	353
05:30 PM	13	164	3	0	180	12	118	5	0	135	1	0	3	1	5	7	1	11	0	19	339
Total Volume	39	670	12	0	721	63	481	13	0	557	6	2	17	5	30	23	6	50	2	81	1389
% App. Total	5.4	92.9	1.7	0		11.3	86.4	2.3	0		20	6.7	56.7	16.7		28.4	7.4	61.7	2.5		
PHF	.750	.915	.750	.000	.934	.829	.878	.650	.000	.893	.375	.500	.607	.417	.682	.719	.500	.595	.500	.614	.954

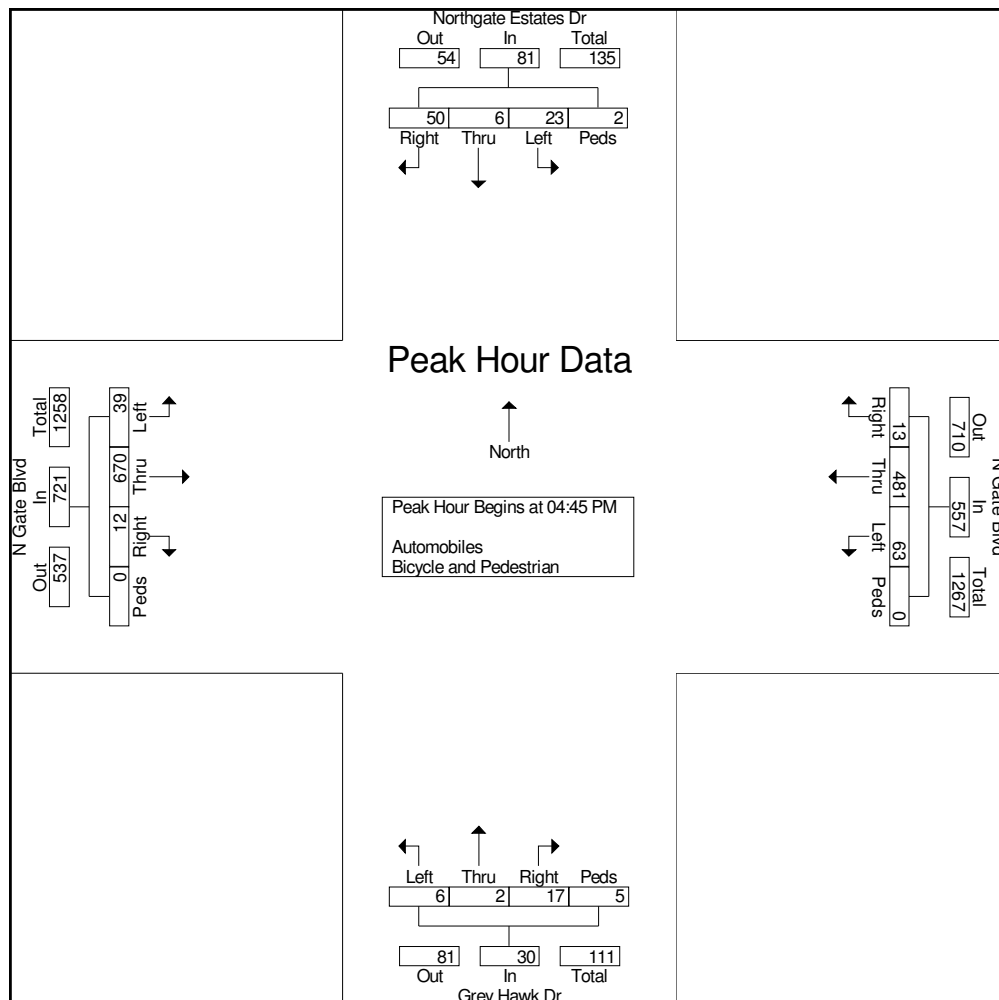



Colorado Springs, CO
 Voyager and Spectrum Multifamily
 AM Peak
 Spectrum Loop & Voyager Pkwy

File Name : Spectrum and Voyager AM
 Site Code : IPO 587
 Start Date : 1/26/2022
 Page No : 1

Groups Printed- Automobiles - Bicycle and Pedestrian

Start Time	Spectrum Loop Eastbound					Spectrum Loop Westbound					Voyager Pkwy Northbound					Voyager Pkwy Southbound					Int. Total
	Left	Thru	Right	Peds	App. Total	Left	Thru	Right	Peds	App. Total	Left	Thru	Right	Peds	App. Total	Left	Thru	Right	Peds	App. Total	
07:00 AM	0	1	12	0	13	7	0	4	0	11	10	26	5	0	41	0	70	2	0	72	137
07:15 AM	2	2	13	0	17	21	2	5	1	29	15	62	8	0	85	1	136	1	0	138	269
07:30 AM	4	0	18	0	22	19	2	4	0	25	15	91	10	0	116	0	151	6	0	157	320
07:45 AM	7	1	14	0	22	38	2	3	0	43	19	86	20	0	125	2	134	16	0	152	342
Total	13	4	57	0	74	85	6	16	1	108	59	265	43	0	367	3	491	25	0	519	1068
08:00 AM	4	3	13	0	20	25	4	7	0	36	20	80	20	0	120	4	114	9	0	127	303
08:15 AM	4	0	12	0	16	17	7	4	1	29	15	45	21	0	81	0	85	12	0	97	223
08:30 AM	10	1	21	0	32	17	3	2	0	22	17	55	26	0	98	1	63	5	0	69	221
08:45 AM	4	3	6	0	13	21	7	5	0	33	27	53	36	0	116	8	63	3	0	74	236
Total	22	7	52	0	81	80	21	18	1	120	79	233	103	0	415	13	325	29	0	367	983
Grand Total	35	11	109	0	155	165	27	34	2	228	138	498	146	0	782	16	816	54	0	886	2051
Apprch %	22.6	7.1	70.3	0		72.4	11.8	14.9	0.9		17.6	63.7	18.7	0		1.8	92.1	6.1	0		
Total %	1.7	0.5	5.3	0	7.6	8	1.3	1.7	0.1	11.1	6.7	24.3	7.1	0	38.1	0.8	39.8	2.6	0	43.2	
Automobiles	35	11	109	0	155	165	27	34	0	226	138	498	146	0	782	16	816	54	0	886	2049
% Automobiles	100	100	100	0	100	100	100	100	0	99.1	100	100	100	0	100	100	100	100	0	100	99.9
Bicycle and Pedestrian	0	0	0	0	0	0	0	0	2	2	0	0	0	0	0	0	0	0	0	0	2
% Bicycle and Pedestrian	0	0	0	0	0	0	0	0	100	0.9	0	0	0	0	0	0	0	0	0	0	0.1



Ridgeview Data
Collection

Colorado Springs, CO
Voyager and Spectrum Multifamily
AM Peak
Spectrum Loop & Voyager Pkwy

File Name : Spectrum and Voyager AM
Site Code : IPO 587
Start Date : 1/26/2022
Page No : 2

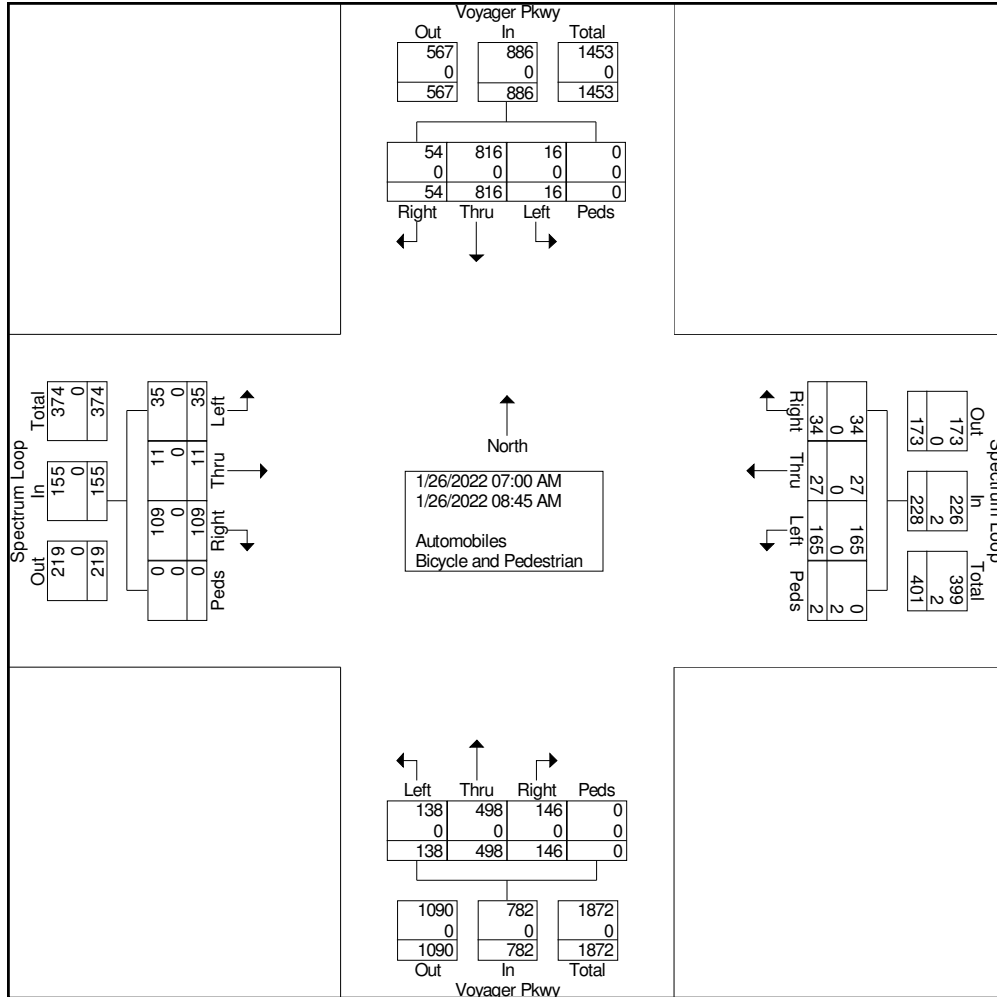



Ridgeview Data
Collection

Colorado Springs, CO
Voyager and Spectrum Multifamily
AM Peak
Spectrum Loop & Voyager Pkwy

File Name : Spectrum and Voyager AM
Site Code : IPO 587
Start Date : 1/26/2022
Page No : 3

Start Time	Spectrum Loop Eastbound					Spectrum Loop Westbound					Voyager Pkwy Northbound					Voyager Pkwy Southbound					Int. Total
	Left	Thru	Right	Peds	App. Total	Left	Thru	Right	Peds	App. Total	Left	Thru	Right	Peds	App. Total	Left	Thru	Right	Peds	App. Total	
Peak Hour Analysis From 07:00 AM to 08:45 AM - Peak 1 of 1																					
Peak Hour for Entire Intersection Begins at 07:15 AM																					
07:15 AM	2	2	13	0	17	21	2	5	1	29	15	62	8	0	85	1	136	1	0	138	269
07:30 AM	4	0	18	0	22	19	2	4	0	25	15	91	10	0	116	0	151	6	0	157	320
07:45 AM	7	1	14	0	22	38	2	3	0	43	19	86	20	0	125	2	134	16	0	152	342
08:00 AM	4	3	13	0	20	25	4	7	0	36	20	80	20	0	120	4	114	9	0	127	303
Total Volume	17	6	58	0	81	103	10	19	1	133	69	319	58	0	446	7	535	32	0	574	1234
% App. Total	21	7.4	71.6	0		77.4	7.5	14.3	0.8		15.5	71.5	13	0		1.2	93.2	5.6	0		
PHF	.607	.500	.806	.000	.920	.678	.625	.679	.250	.773	.863	.876	.725	.000	.892	.438	.886	.500	.000	.914	.902

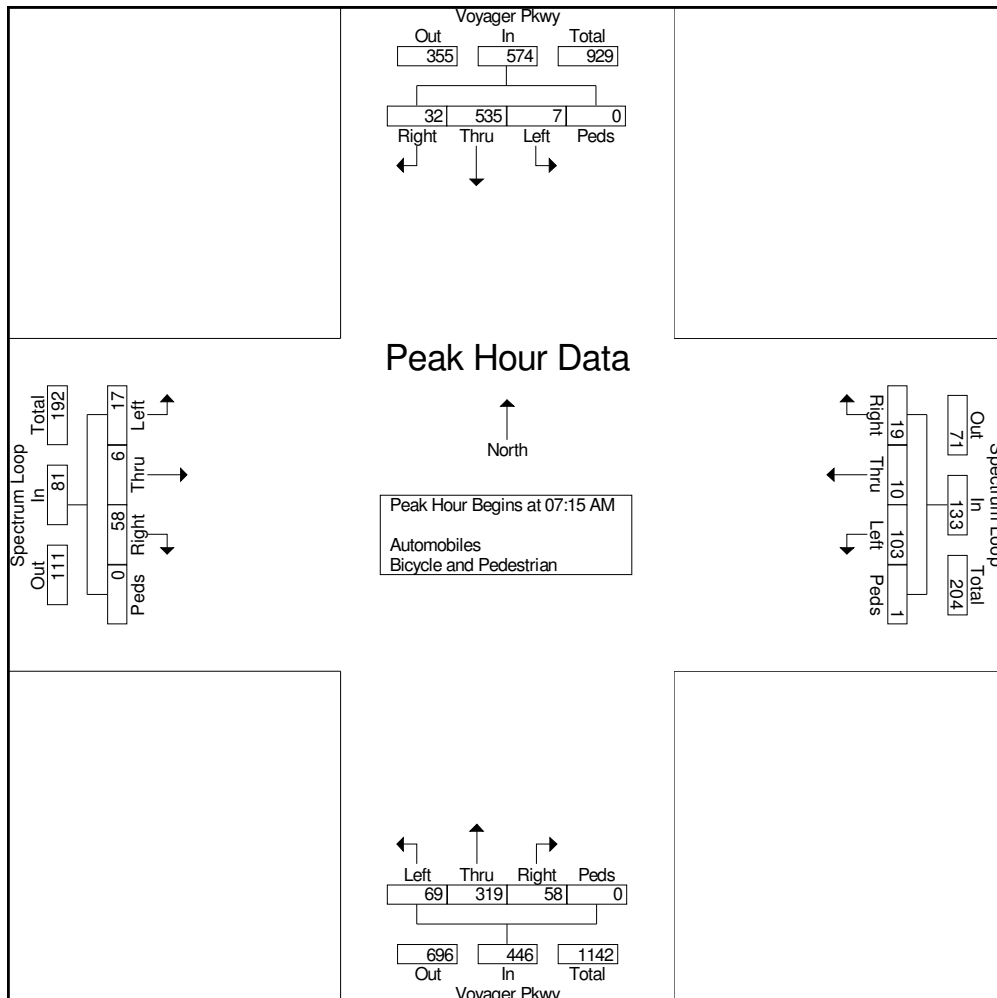

Voyager Pkwy N Spectrum Loop



Peak Hour

Date: 08/25/2022
Count Period: 2:00 PM to 4:00 PM
Peak Hour: 3:00 PM to 4:00 PM

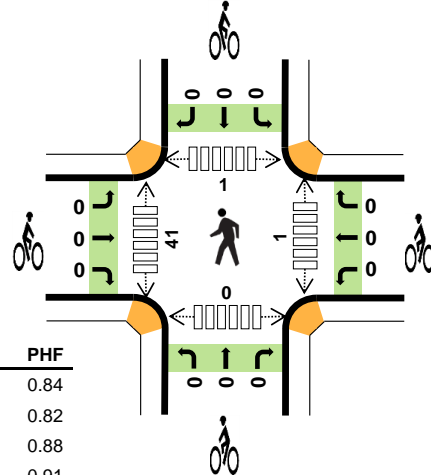
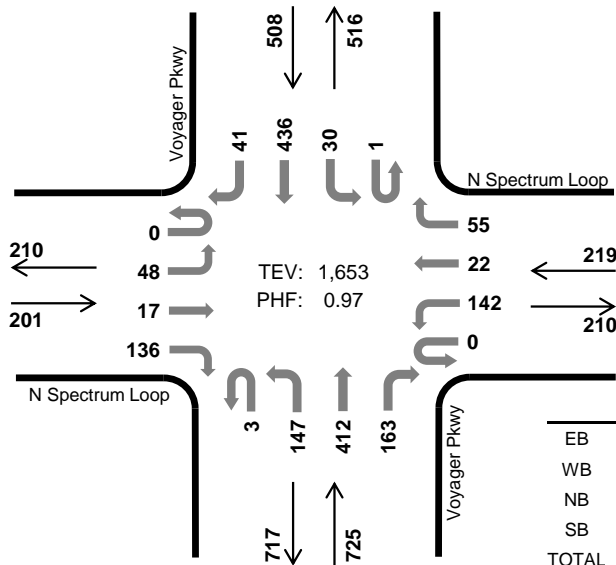

	HV %:	PHF
EB	0.5%	0.84
WB	1.4%	0.82
NB	1.1%	0.88
SB	1.6%	0.91
TOTAL	1.2%	0.97

Two-Hour Count Summaries

Interval Start	N Spectrum Loop Eastbound				N Spectrum Loop Westbound				Voyager Pkwy Northbound				Voyager Pkwy Southbound				15-min Total	Rolling One Hour	
	UT	LT	TH	RT	UT	LT	TH	RT	UT	LT	TH	RT	UT	LT	TH	RT			
2:00 PM	0	15	6	58	0	29	6	5	3	36	63	39	0	7	68	15	350	0	
2:15 PM	0	17	4	36	0	31	9	17	1	34	66	33	0	3	91	9	351	0	
2:30 PM	0	17	3	41	0	39	5	11	0	25	63	29	0	2	87	3	325	0	
2:45 PM	0	15	3	36	0	24	2	14	1	30	85	37	1	4	100	13	365	1,391	
3:00 PM	0	10	1	30	0	47	5	15	1	22	96	38	0	6	124	9	404	1,445	
3:15 PM	0	10	1	38	0	27	7	15	0	44	128	34	0	8	102	11	425	1,519	
3:30 PM	0	19	5	36	0	45	3	11	2	37	86	42	0	7	121	11	425	1,619	
3:45 PM	0	9	10	32	0	23	7	14	0	44	102	49	1	9	89	10	399	1,653	
Count Total	0	112	33	307	0	265	44	102	8	272	689	301	2	46	782	81	3,044	0	
Peak Hour	All	0	48	17	136	0	142	22	55	3	147	412	163	1	30	436	41	1,653	0
	HV	0	0	1	0	0	2	0	1	0	0	4	4	0	0	7	1	20	0
	HV%	-	0%	6%	0%	-	1%	0%	2%	0%	0%	1%	2%	0%	0%	2%	2%	1%	0

Note: Two-hour count summary volumes include heavy vehicles but exclude bicycles in overall count.

Interval Start	Heavy Vehicle Totals					Bicycles					Pedestrians (Crossing Leg)				
	EB	WB	NB	SB	Total	EB	WB	NB	SB	Total	East	West	North	South	Total
2:00 PM	1	0	0	4	5	0	0	1	0	1	1	0	0	0	1
2:15 PM	1	1	3	0	5	0	0	0	0	0	0	0	0	0	0
2:30 PM	1	2	2	0	5	0	0	0	0	0	0	1	0	0	1
2:45 PM	0	3	2	1	6	0	0	0	0	0	0	0	0	0	0
3:00 PM	0	1	1	1	3	0	0	0	0	0	0	0	0	0	0
3:15 PM	1	1	5	2	9	0	0	0	0	0	1	1	0	0	2
3:30 PM	0	1	1	4	6	0	0	0	0	0	0	1	1	0	2
3:45 PM	0	0	1	1	2	0	0	0	0	0	0	39	0	0	39
Count Total	4	9	15	13	41	0	0	1	0	1	2	42	1	0	45
Peak Hour	1	3	8	8	20	0	0	0	0	0	1	41	1	0	43

Two-Hour Count Summaries - Heavy Vehicles																		
Interval Start	N Spectrum Loop				N Spectrum Loop				Voyager Pkwy				Voyager Pkwy				15-min Total	Rolling One Hour
	Eastbound				Westbound				Northbound				Southbound					
	UT	LT	TH	RT	UT	LT	TH	RT	UT	LT	TH	RT	UT	LT	TH	RT		
2:00 PM	0	0	0	1	0	0	0	0	0	0	0	0	0	0	3	1	5	0
2:15 PM	0	0	0	1	0	1	0	0	0	1	2	0	0	0	0	0	5	0
2:30 PM	0	0	0	1	0	2	0	0	0	1	1	0	0	0	0	0	5	0
2:45 PM	0	0	0	0	0	3	0	0	0	0	1	1	0	0	1	0	6	21
3:00 PM	0	0	0	0	0	1	0	0	0	0	0	1	0	0	1	0	3	19
3:15 PM	0	0	1	0	0	1	0	0	0	0	3	2	0	0	1	1	9	23
3:30 PM	0	0	0	0	0	0	0	1	0	0	0	1	0	0	4	0	6	24
3:45 PM	0	0	0	0	0	0	0	0	0	0	1	0	0	0	1	0	2	20
Count Total	0	0	1	3	0	8	0	1	0	2	8	5	0	0	11	2	41	0
Peak Hour	0	0	1	0	0	2	0	1	0	0	4	4	0	0	7	1	20	0
Two-Hour Count Summaries - Bikes																		
Interval Start	N Spectrum Loop			N Spectrum Loop			Voyager Pkwy			Voyager Pkwy			15-min Total	Rolling One Hour				
	Eastbound			Westbound			Northbound			Southbound								
	LT	TH	RT	LT	TH	RT	LT	TH	RT	LT	TH	RT						
2:00 PM	0	0	0	0	0	0	0	0	1	0	0	0	1	0	0	0	0	
2:15 PM	0	0	0	0	0	0	0	0	0	0	0	0	0	0	0	0	0	
2:30 PM	0	0	0	0	0	0	0	0	0	0	0	0	0	0	0	0	0	
2:45 PM	0	0	0	0	0	0	0	0	0	0	0	0	0	0	0	0	1	
3:00 PM	0	0	0	0	0	0	0	0	0	0	0	0	0	0	0	0	0	
3:15 PM	0	0	0	0	0	0	0	0	0	0	0	0	0	0	0	0	0	
3:30 PM	0	0	0	0	0	0	0	0	0	0	0	0	0	0	0	0	0	
3:45 PM	0	0	0	0	0	0	0	0	0	0	0	0	0	0	0	0	0	
Count Total	0	0	0	0	0	0	0	0	1	0	0	0	0	0	0	1	0	
Peak Hour	0	0	0	0	0	0	0	0	0	0	0	0	0	0	0	0	0	
<i>Note: U-Turn volumes for bikes are included in Left-Turn, if any.</i>																		



Colorado Springs, CO
 Voyager and Spectrum Multifamily
 PM Peak
 Spectrum Loop & Voyager Pkwy

File Name : Spectrum and Voyager PM
 Site Code : IPO 587
 Start Date : 1/26/2022
 Page No : 1

Groups Printed- Automobiles - Bicycle and Pedestrian

Start Time	Spectrum Loop Eastbound					Spectrum Loop Westbound					Voyager Pkwy Northbound					Voyager Pkwy Southbound					Int. Total
	Left	Thru	Right	Peds	App. Total	Left	Thru	Right	Peds	App. Total	Left	Thru	Right	Peds	App. Total	Left	Thru	Right	Peds	App. Total	
04:00 PM	16	4	34	0	54	36	9	18	0	63	35	67	39	0	141	10	80	17	0	107	365
04:15 PM	13	4	29	1	47	34	1	16	0	51	43	86	38	0	167	5	102	12	1	120	385
04:30 PM	15	4	31	1	51	42	6	13	0	61	43	85	51	0	179	11	84	8	1	104	395
04:45 PM	9	8	29	1	47	31	5	13	2	51	61	98	43	0	202	8	85	22	0	115	415
Total	53	20	123	3	199	143	21	60	2	226	182	336	171	0	689	34	351	59	2	446	1560
05:00 PM	23	12	59	0	94	61	11	18	0	90	49	90	48	0	187	9	83	14	0	106	477
05:15 PM	19	11	43	0	73	33	8	16	0	57	38	88	59	0	185	6	80	7	0	93	408
05:30 PM	18	3	35	0	56	36	9	20	0	65	36	83	36	0	155	6	92	14	0	112	388
05:45 PM	18	4	25	0	47	29	10	13	0	52	38	72	33	0	143	3	71	12	0	86	328
Total	78	30	162	0	270	159	38	67	0	264	161	333	176	0	670	24	326	47	0	397	1601
Grand Total	131	50	285	3	469	302	59	127	2	490	343	669	347	0	1359	58	677	106	2	843	3161
Apprch %	27.9	10.7	60.8	0.6		61.6	12	25.9	0.4		25.2	49.2	25.5	0		6.9	80.3	12.6	0.2		
Total %	4.1	1.6	9	0.1	14.8	9.6	1.9	4	0.1	15.5	10.9	21.2	11	0	43	1.8	21.4	3.4	0.1	26.7	
Automobiles	131	50	285	0	466	302	59	127	0	488	343	669	347	0	1359	58	677	106	0	841	3154
% Automobiles	100	100	100	0	99.4	100	100	100	0	99.6	100	100	100	0	100	100	100	100	0	99.8	99.8
Bicycle and Pedestrian	0	0	0	3	3	0	0	0	2	2	0	0	0	0	0	0	0	0	2	2	7
% Bicycle and Pedestrian	0	0	0	100	0.6	0	0	0	100	0.4	0	0	0	0	0	0	0	0	100	0.2	0.2



Ridgeview Data
Collection

Colorado Springs, CO
Voyager and Spectrum Multifamily
PM Peak
Spectrum Loop & Voyager Pkwy

File Name : Spectrum and Voyager PM
Site Code : IPO 587
Start Date : 1/26/2022
Page No : 2

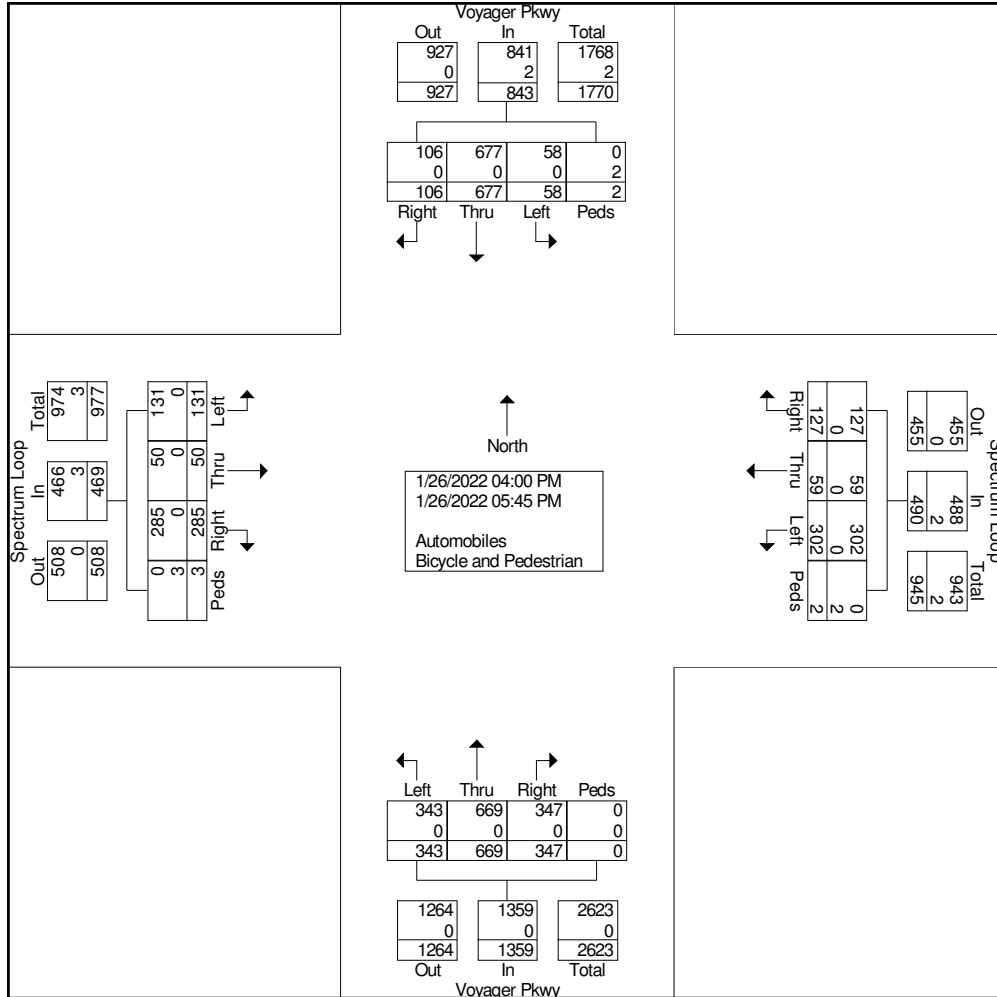



Ridgeview Data
Collection

Colorado Springs, CO
Voyager and Spectrum Multifamily
PM Peak
Spectrum Loop & Voyager Pkwy

File Name : Spectrum and Voyager PM
Site Code : IPO 587
Start Date : 1/26/2022
Page No : 3

Start Time	Spectrum Loop Eastbound					Spectrum Loop Westbound					Voyager Pkwy Northbound					Voyager Pkwy Southbound					Int. Total
	Left	Thru	Right	Peds	App. Total	Left	Thru	Right	Peds	App. Total	Left	Thru	Right	Peds	App. Total	Left	Thru	Right	Peds	App. Total	
Peak Hour Analysis From 04:00 PM to 05:45 PM - Peak 1 of 1																					
Peak Hour for Entire Intersection Begins at 04:30 PM																					
04:30 PM	15	4	31	1	51	42	6	13	0	61	43	85	51	0	179	11	84	8	1	104	395
04:45 PM	9	8	29	1	47	31	5	13	2	51	61	98	43	0	202	8	85	22	0	115	415
05:00 PM	23	12	59	0	94	61	11	18	0	90	49	90	48	0	187	9	83	14	0	106	477
05:15 PM	19	11	43	0	73	33	8	16	0	57	38	88	59	0	185	6	80	7	0	93	408
Total Volume	66	35	162	2	265	167	30	60	2	259	191	361	201	0	753	34	332	51	1	418	1695
% App. Total	24.9	13.2	61.1	0.8		64.5	11.6	23.2	0.8		25.4	47.9	26.7	0		8.1	79.4	12.2	0.2		
PHF	.717	.729	.686	.500	.705	.684	.682	.833	.250	.719	.783	.921	.852	.000	.932	.773	.976	.580	.250	.909	.888

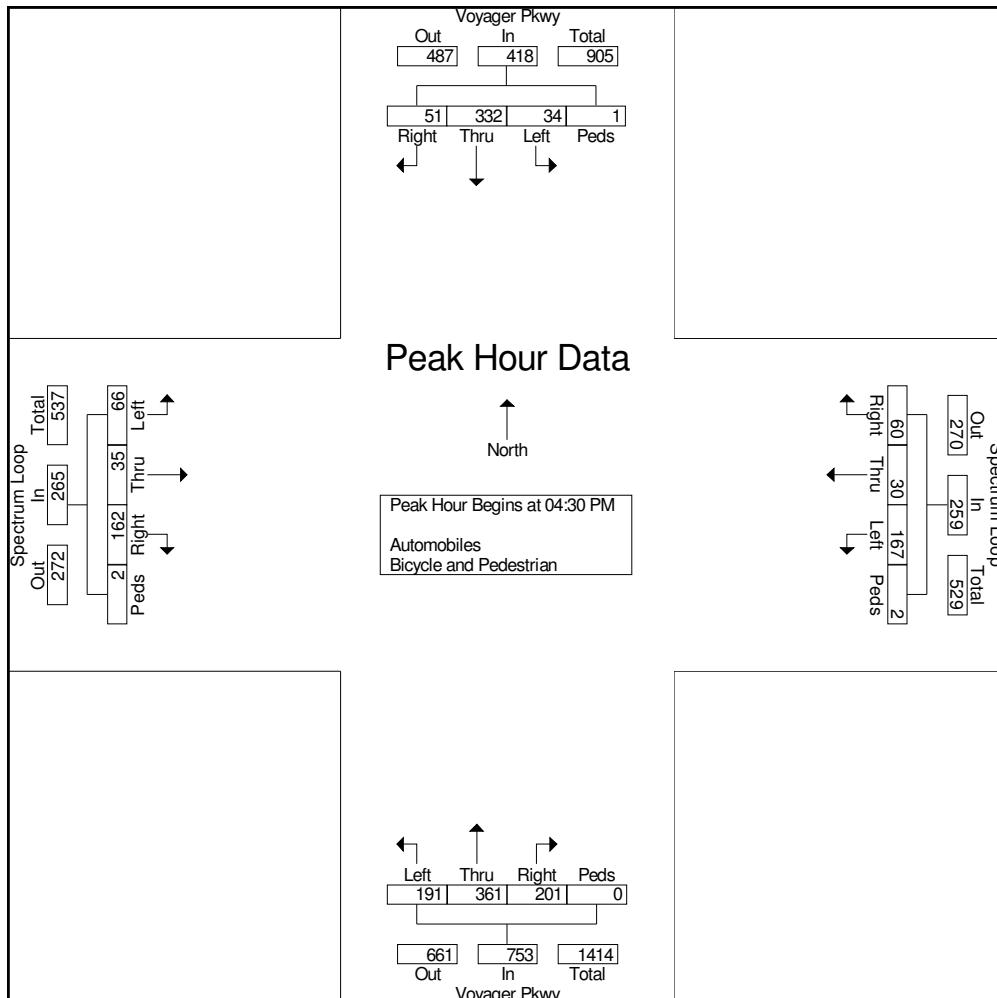



Ridgeview Data
Collection

Colorado Springs, CO
Voyager and Spectrum Multifamily
AM Peak
Spectrum Loop & Grey Hawk Dr

File Name : Spectrum and Grey Hawk AM
Site Code : IPO 587
Start Date : 1/26/2022
Page No : 2

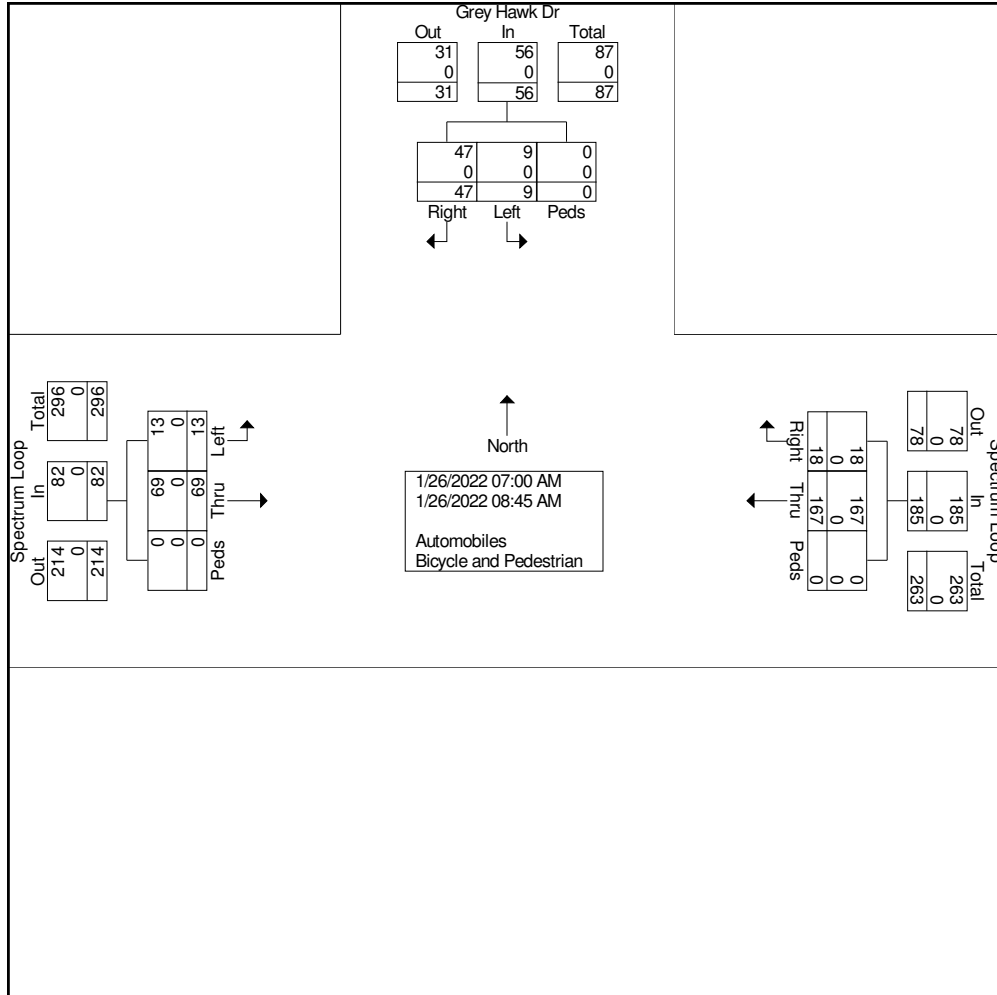



Ridgeview Data
Collection

Colorado Springs, CO
Voyager and Spectrum Multifamily
AM Peak
Spectrum Loop & Grey Hawk Dr

File Name : Spectrum and Grey Hawk AM
Site Code : IPO 587
Start Date : 1/26/2022
Page No : 3

Start Time	Spectrum Loop Eastbound				Spectrum Loop Westbound				Grey Hawk Dr Southbound				Int. Total
	Left	Thru	Peds	App. Total	Thru	Right	Peds	App. Total	Left	Right	Peds	App. Total	
Peak Hour Analysis From 07:00 AM to 08:45 AM - Peak 1 of 1													
Peak Hour for Entire Intersection Begins at 07:30 AM													
07:30 AM	2	3	0	5	24	3	0	27	0	5	0	5	37
07:45 AM	1	8	0	9	37	1	0	38	1	9	0	10	57
08:00 AM	3	12	0	15	20	2	0	22	2	8	0	10	47
08:15 AM	2	10	0	12	22	0	0	22	2	6	0	8	42
Total Volume	8	33	0	41	103	6	0	109	5	28	0	33	183
% App. Total	19.5	80.5	0		94.5	5.5	0		15.2	84.8	0		
PHF	.667	.688	.000	.683	.696	.500	.000	.717	.625	.778	.000	.825	.803

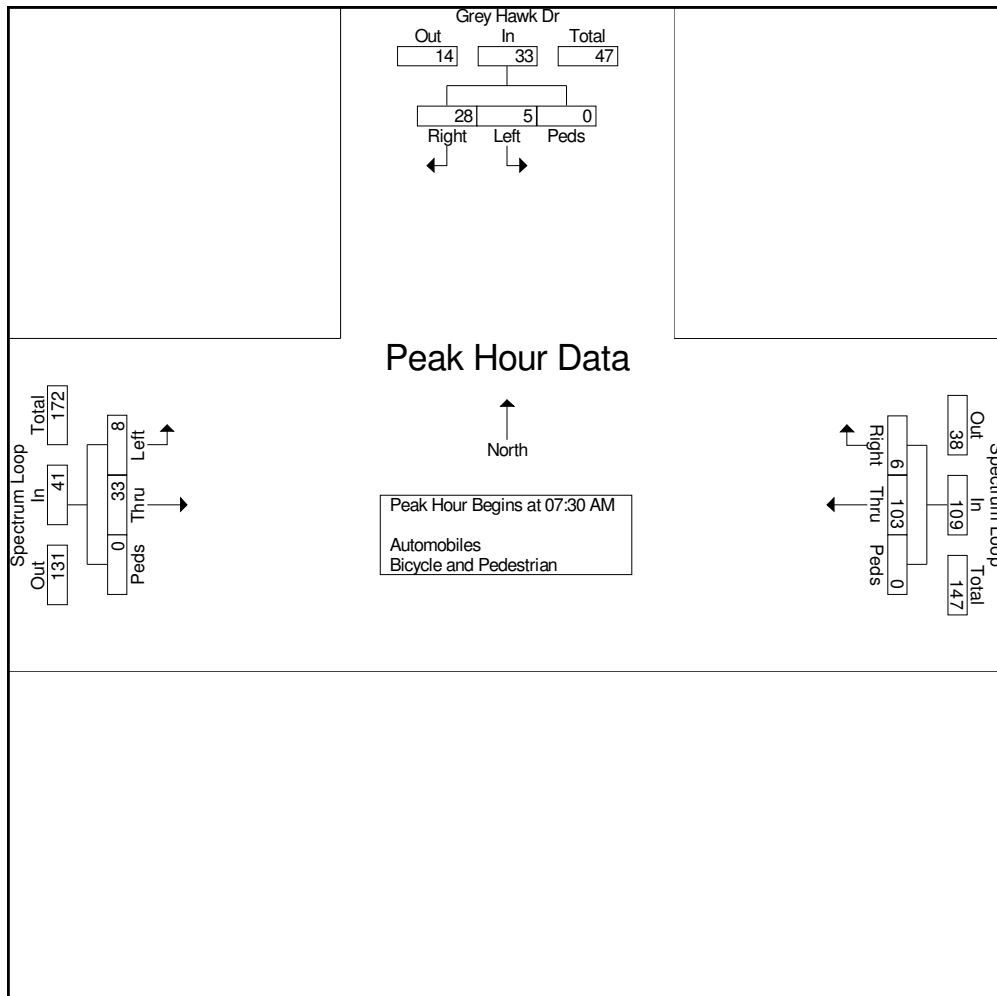

Grey Hawk Dr N Spectrum Loop

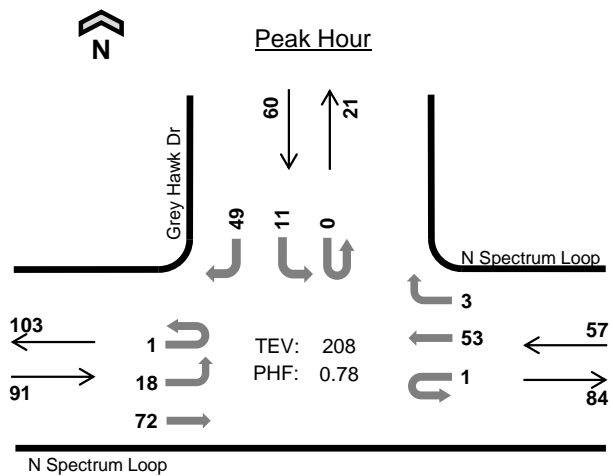

Date: 08/25/2022
 Count Period: 2:00 PM to 4:00 PM
 Peak Hour: 3:00 PM to 4:00 PM

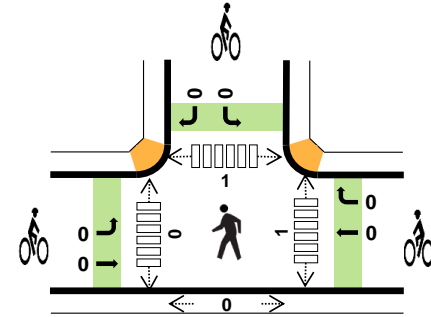

	HV %:	PHF
EB	3.3%	0.71
WB	3.5%	0.79
NB	-	-
SB	3.3%	0.71
TOTAL	3.4%	0.78

Two-Hour Count Summaries

Interval Start	N Spectrum Loop Eastbound				N Spectrum Loop Westbound				N/A Northbound				Grey Hawk Dr Southbound				15-min Total	Rolling One Hour	
	UT	LT	TH	RT	UT	LT	TH	RT	UT	LT	TH	RT	UT	LT	TH	RT			
	2:00 PM	0	0	12	0	0	0	11	1	0	0	0	0	0	2	0			3
2:15 PM	0	3	10	0	0	0	12	1	0	0	0	0	0	0	0	8	34	0	
2:30 PM	0	1	6	0	0	0	12	2	0	0	0	0	0	0	0	8	29	0	
2:45 PM	0	6	16	0	0	0	13	3	0	0	0	0	0	4	0	10	52	144	
3:00 PM	0	3	18	0	0	0	9	2	0	0	0	0	0	1	0	12	45	160	
3:15 PM	0	4	11	0	0	0	10	0	0	0	0	0	0	0	0	9	34	160	
3:30 PM	0	6	17	0	0	0	17	1	0	0	0	0	0	4	0	17	62	193	
3:45 PM	1	5	26	0	1	0	17	0	0	0	0	0	0	6	0	11	67	208	
Count Total	1	28	116	0	1	0	101	10	0	0	0	0	0	17	0	78	352	0	
Peak Hour	All	1	18	72	0	1	0	53	3	0	0	0	0	0	11	0	49	208	0
	HV	0	1	2	0	1	0	1	0	0	0	0	0	0	0	0	2	7	0
	HV%	0%	6%	3%	-	100%	-	2%	0%	-	-	-	-	-	0%	-	4%	3%	0

Note: Two-hour count summary volumes include heavy vehicles but exclude bicycles in overall count.

Interval Start	Heavy Vehicle Totals					Bicycles					Pedestrians (Crossing Leg)					
	EB	WB	NB	SB	Total	EB	WB	NB	SB	Total	East	West	North	South	Total	
2:00 PM	0	0	0	0	0	0	0	0	0	0	0	0	0	0	0	
2:15 PM	0	0	0	1	1	0	0	0	0	0	0	0	0	2	0	2
2:30 PM	0	1	0	1	2	0	0	0	0	0	0	1	0	1	2	
2:45 PM	1	1	0	1	3	0	0	0	0	0	0	0	0	0	0	
3:00 PM	0	1	0	1	2	0	0	0	0	0	0	0	0	0	0	
3:15 PM	2	0	0	1	3	0	0	0	0	0	1	0	1	0	2	
3:30 PM	1	0	0	0	1	0	0	0	0	0	0	0	0	0	0	
3:45 PM	0	1	0	0	1	0	0	0	0	0	0	0	0	0	0	
Count Total	4	4	0	5	13	0	0	0	0	0	1	1	3	1	6	
Peak Hr	3	2	0	2	7	0	0	0	0	0	1	0	1	0	2	

Two-Hour Count Summaries - Heavy Vehicles																			
Interval Start	N Spectrum Loop				N Spectrum Loop				N/A				Grey Hawk Dr				15-min Total	Rolling One Hour	
	Eastbound				Westbound				Northbound				Southbound						
	UT	LT	TH	RT	UT	LT	TH	RT	UT	LT	TH	RT	UT	LT	TH	RT			
2:00 PM	0	0	0	0	0	0	0	0	0	0	0	0	0	0	0	0	0	0	0
2:15 PM	0	0	0	0	0	0	0	0	0	0	0	0	0	0	0	0	1	1	0
2:30 PM	0	0	0	0	0	0	1	0	0	0	0	0	0	0	0	0	1	2	0
2:45 PM	0	1	0	0	0	0	1	0	0	0	0	0	0	0	0	0	1	3	6
3:00 PM	0	0	0	0	0	0	1	0	0	0	0	0	0	0	0	0	1	2	8
3:15 PM	0	1	1	0	0	0	0	0	0	0	0	0	0	0	0	0	1	3	10
3:30 PM	0	0	1	0	0	0	0	0	0	0	0	0	0	0	0	0	0	1	9
3:45 PM	0	0	0	0	1	0	0	0	0	0	0	0	0	0	0	0	0	1	7
Count Total	0	2	2	0	1	0	3	0	0	0	0	0	0	0	0	0	5	13	0
Peak Hour	0	1	2	0	1	0	1	0	0	0	0	0	0	0	0	0	2	7	0

Two-Hour Count Summaries - Bikes																			
Interval Start	N Spectrum Loop			N Spectrum Loop			N/A			Grey Hawk Dr			15-min Total	Rolling One Hour					
	Eastbound			Westbound			Northbound			Southbound									
	LT	TH	RT	LT	TH	RT	LT	TH	RT	LT	TH	RT							
2:00 PM	0	0	0	0	0	0	0	0	0	0	0	0	0	0	0	0	0	0	0
2:15 PM	0	0	0	0	0	0	0	0	0	0	0	0	0	0	0	0	0	0	0
2:30 PM	0	0	0	0	0	0	0	0	0	0	0	0	0	0	0	0	0	0	0
2:45 PM	0	0	0	0	0	0	0	0	0	0	0	0	0	0	0	0	0	0	0
3:00 PM	0	0	0	0	0	0	0	0	0	0	0	0	0	0	0	0	0	0	0
3:15 PM	0	0	0	0	0	0	0	0	0	0	0	0	0	0	0	0	0	0	0
3:30 PM	0	0	0	0	0	0	0	0	0	0	0	0	0	0	0	0	0	0	0
3:45 PM	0	0	0	0	0	0	0	0	0	0	0	0	0	0	0	0	0	0	0
Count Total	0	0	0	0	0	0	0	0	0	0	0	0	0	0	0	0	0	0	0
Peak Hour	0	0	0	0	0	0	0	0	0	0	0	0	0	0	0	0	0	0	0

Note: U-Turn volumes for bikes are included in Left-Turn, if any.



Ridgeview Data
Collection

Colorado Springs, CO
Voyager and Spectrum Multifamily
PM Peak
Spectrum Loop & Grey Hawk Dr

File Name : Spectrum and Grey Hawk PM
Site Code : IPO 587
Start Date : 1/26/2022
Page No : 1

Groups Printed- Automobiles - Bicycle and Pedestrian

Start Time	Spectrum Loop Eastbound				Spectrum Loop Westbound				Grey Hawk Dr Southbound				Int. Total
	Left	Thru	Peds	App. Total	Thru	Right	Peds	App. Total	Left	Right	Peds	App. Total	
04:00 PM	1	23	0	24	15	1	0	16	5	11	0	16	56
04:15 PM	5	17	2	24	16	0	0	16	1	14	4	19	59
04:30 PM	5	18	0	23	14	3	0	17	6	17	0	23	63
04:45 PM	6	18	0	24	18	1	0	19	4	12	0	16	59
Total	17	76	2	95	63	5	0	68	16	54	4	74	237
05:00 PM	3	16	0	19	21	3	0	24	4	17	0	21	64
05:15 PM	3	31	1	35	13	2	0	15	4	16	4	24	74
05:30 PM	3	18	0	21	17	1	0	18	5	7	0	12	51
05:45 PM	3	18	0	21	17	1	0	18	4	7	0	11	50
Total	12	83	1	96	68	7	0	75	17	47	4	68	239
Grand Total	29	159	3	191	131	12	0	143	33	101	8	142	476
Apprch %	15.2	83.2	1.6		91.6	8.4	0		23.2	71.1	5.6		
Total %	6.1	33.4	0.6	40.1	27.5	2.5	0	30	6.9	21.2	1.7	29.8	
Automobiles	29	159	0	188	131	12	0	143	33	101	0	134	465
% Automobiles	100	100	0	98.4	100	100	0	100	100	100	0	94.4	97.7
Bicycle and Pedestrian	0	0	3	3	0	0	0	0	0	0	8	8	11
% Bicycle and Pedestrian	0	0	100	1.6	0	0	0	0	0	0	100	5.6	2.3



Ridgeview Data
Collection

Colorado Springs, CO
Voyager and Spectrum Multifamily
PM Peak
Spectrum Loop & Grey Hawk Dr

File Name : Spectrum and Grey Hawk PM
Site Code : IPO 587
Start Date : 1/26/2022
Page No : 2

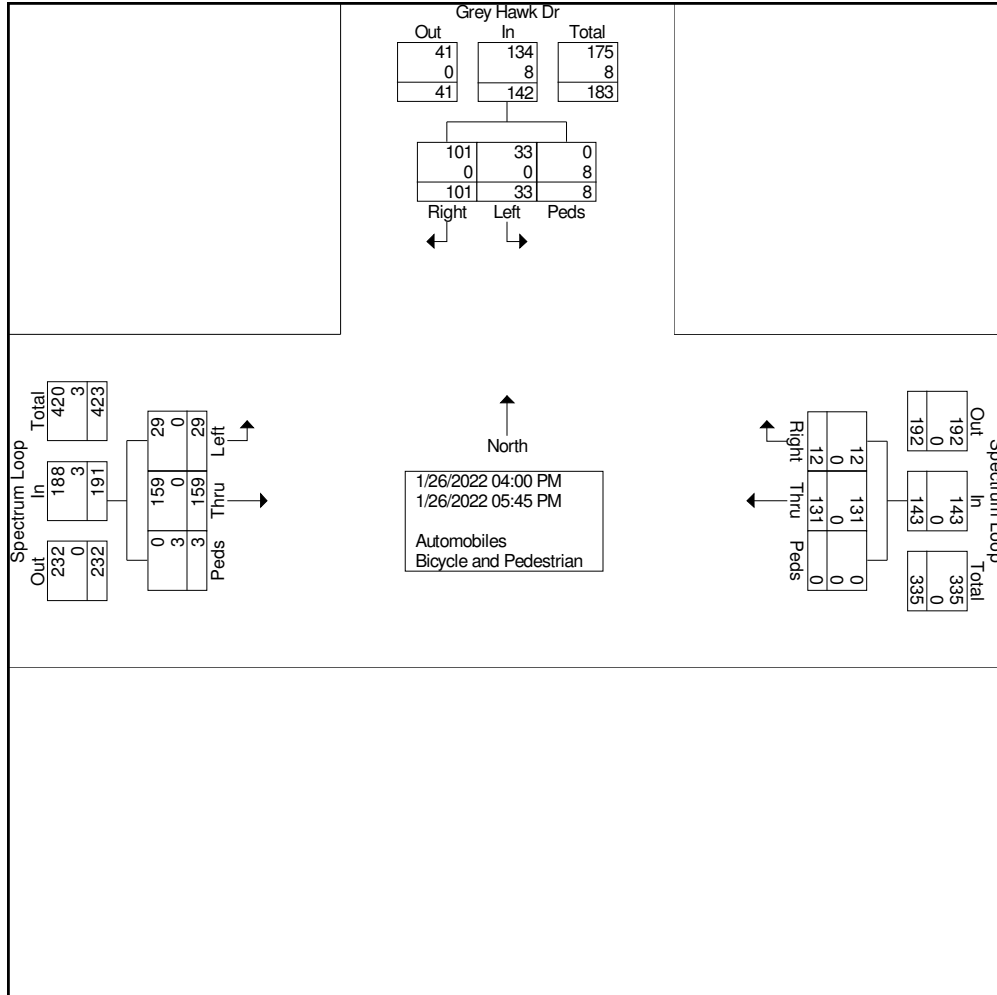



Ridgeview Data
Collection

Colorado Springs, CO
Voyager and Spectrum Multifamily
PM Peak
Spectrum Loop & Grey Hawk Dr

File Name : Spectrum and Grey Hawk PM
Site Code : IPO 587
Start Date : 1/26/2022
Page No : 3

Start Time	Spectrum Loop Eastbound				Spectrum Loop Westbound				Grey Hawk Dr Southbound				Int. Total
	Left	Thru	Peds	App. Total	Thru	Right	Peds	App. Total	Left	Right	Peds	App. Total	
Peak Hour Analysis From 04:00 PM to 05:45 PM - Peak 1 of 1													
Peak Hour for Entire Intersection Begins at 04:30 PM													
04:30 PM	5	18	0	23	14	3	0	17	6	17	0	23	63
04:45 PM	6	18	0	24	18	1	0	19	4	12	0	16	59
05:00 PM	3	16	0	19	21	3	0	24	4	17	0	21	64
05:15 PM	3	31	1	35	13	2	0	15	4	16	4	24	74
Total Volume	17	83	1	101	66	9	0	75	18	62	4	84	260
% App. Total	16.8	82.2	1		88	12	0		21.4	73.8	4.8		
PHF	.708	.669	.250	.721	.786	.750	.000	.781	.750	.912	.250	.875	.878

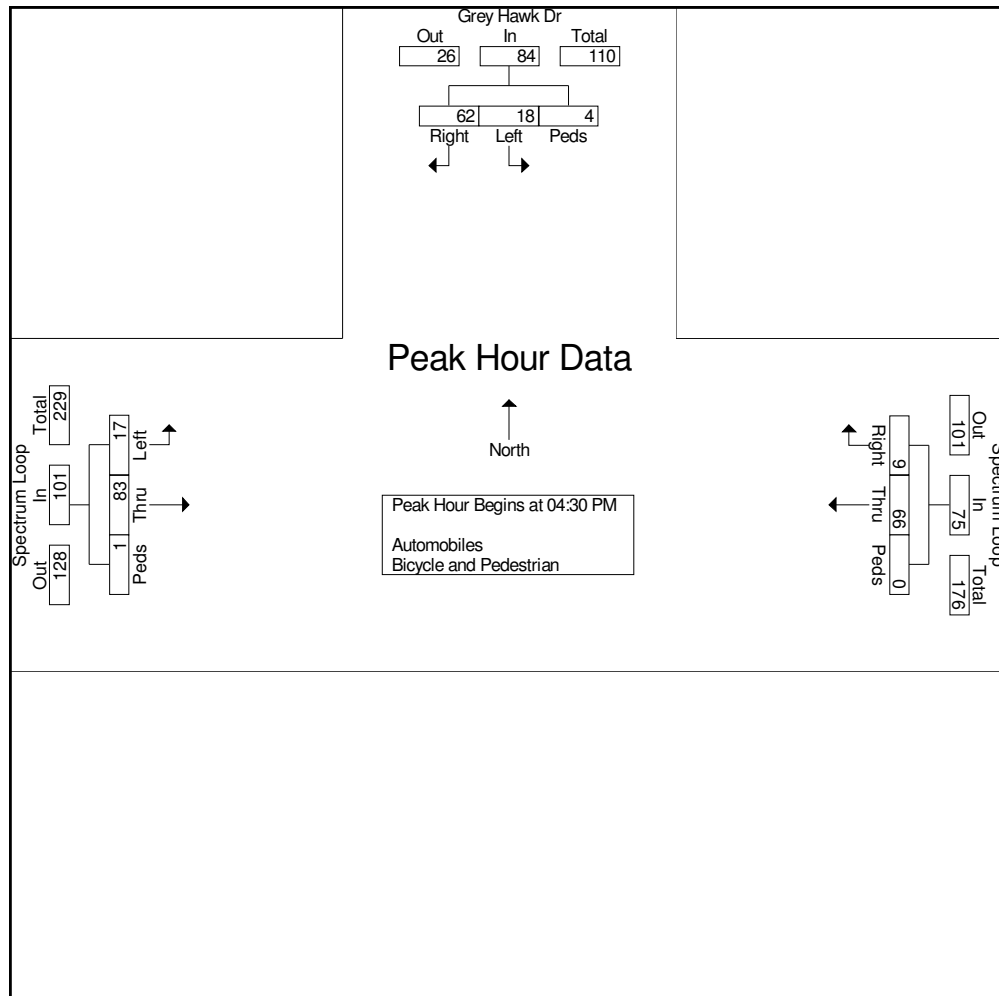



ALL TRAFFIC DATA SERVICES

(303) 216-2439

www.alltrafficdata.net

Location: 4 VOYAGER PKWY & I-25 ON RAMPS AM

Date: Tuesday, April 26, 2022

Peak Hour: 07:15 AM - 08:15 AM

Peak 15-Minutes: 07:30 AM - 07:45 AM

Peak Hour - All Vehicles

Peak Hour - Pedestrians/Bicycles on Crosswalk

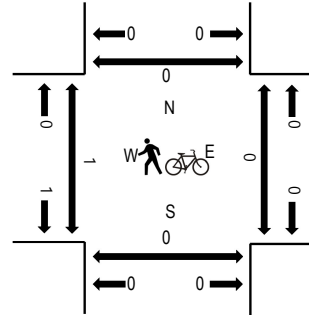
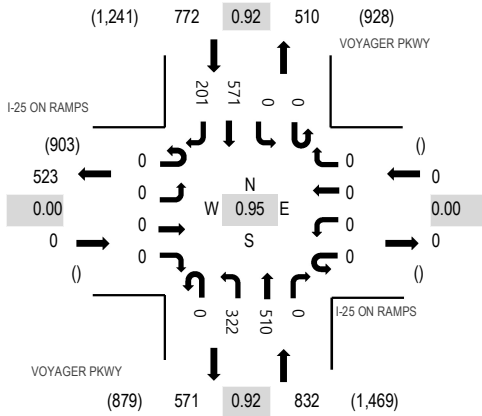

Note: Total study counts contained in parentheses.

Traffic Counts

Interval Start Time	I-25 ON RAMPS Eastbound				I-25 ON RAMPS Westbound				VOYAGER PKWY Northbound			VOYAGER PKWY Southbound				Total	Rolling Hour	Pedestrian Crossings					
	U-Turn	Left	Thru	Right	U-Turn	Left	Thru	Right	U-Turn	Left	Thru	Right	U-Turn	Left	Thru			Right	West	East	South	North	
7:00 AM	0	0	0	0	0	0	0	0	0	67	55	0	0	0	0	74	42	238	1,447	0	0	0	0
7:15 AM	0	0	0	0	0	0	0	0	0	86	100	0	0	0	0	156	47	389	1,604	0	0	0	0
7:30 AM	0	0	0	0	0	0	0	0	0	93	120	0	0	0	0	140	69	422	1,506	0	0	0	0
7:45 AM	0	0	0	0	0	0	0	0	0	77	148	0	0	0	0	139	34	398	1,390	0	0	0	0
8:00 AM	0	0	0	0	0	0	0	0	0	66	142	0	0	0	0	136	51	395	1,263	1	0	0	0
8:15 AM	0	0	0	0	0	0	0	0	0	46	131	0	0	0	0	79	35	291		0	1	0	0
8:30 AM	0	0	0	0	0	0	0	0	0	56	114	0	0	0	0	91	45	306		1	0	0	0
8:45 AM	0	0	0	0	0	0	0	0	0	51	117	0	1	0	0	64	38	271		0	0	0	0
Count Total	0	0	0	0	0	0	0	0	0	542	927	0	1	0	0	879	361	2,710		2	1	0	0
Peak Hour	0	0	0	0	0	0	0	0	0	322	510	0	0	0	0	571	201	1,604		1	0	0	0

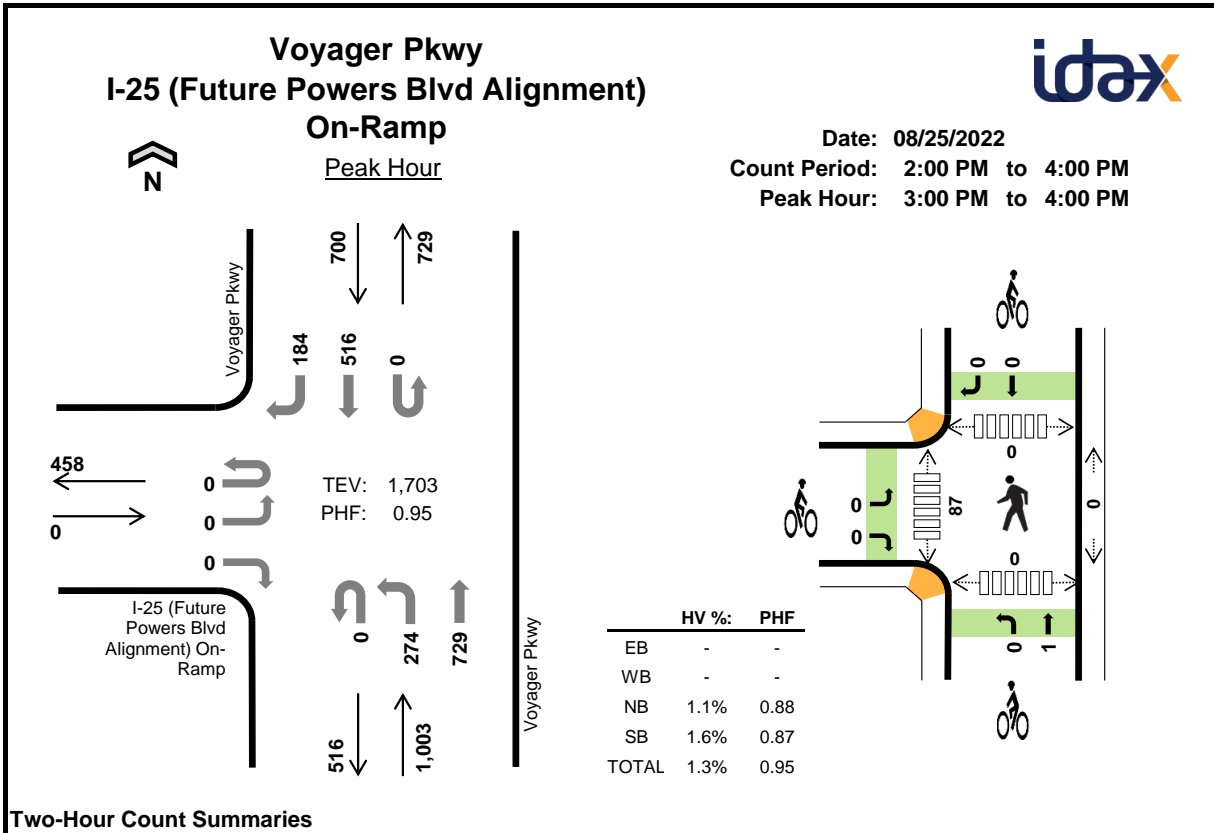

Two-Hour Count Summaries

Interval Start	I-25 (Future Powers Blvd Alignment) On-Ramp				N/A				Voyager Pkwy				Voyager Pkwy				15-min Total	Rolling One Hour	
	Eastbound				Westbound				Northbound				Southbound						
	UT	LT	TH	RT	UT	LT	TH	RT	UT	LT	TH	RT	UT	LT	TH	RT			
2:00 PM	0	0	0	0	0	0	0	0	0	52	141	0	0	0	111	36	340	0	
2:15 PM	0	0	0	0	0	0	0	0	0	40	134	0	0	0	119	33	326	0	
2:30 PM	0	0	0	0	0	0	0	0	0	58	121	0	0	0	115	45	339	0	
2:45 PM	0	0	0	0	0	0	0	0	0	44	146	0	0	0	122	35	347	1,352	
3:00 PM	0	0	0	0	0	0	0	0	0	66	165	0	0	0	140	54	425	1,437	
3:15 PM	0	0	0	0	0	0	0	0	0	85	200	0	0	0	125	40	450	1,561	
3:30 PM	0	0	0	0	0	0	0	0	0	70	171	0	0	0	143	59	443	1,665	
3:45 PM	0	0	0	0	0	0	0	0	0	53	193	0	0	0	108	31	385	1,703	
Count Total	0	0	0	0	0	0	0	0	0	468	1,271	0	0	0	983	333	3,055	0	
Peak Hour	All	0	0	0	0	0	0	0	0	0	274	729	0	0	0	516	184	1,703	0
	HV	0	0	0	0	0	0	0	0	0	3	8	0	0	0	11	0	22	0
	HV%	-	-	-	-	-	-	-	-	-	1%	1%	-	-	-	2%	0%	1%	0

Note: Two-hour count summary volumes include heavy vehicles but exclude bicycles in overall count.

Interval Start	Heavy Vehicle Totals					Bicycles					Pedestrians (Crossing Leg)				
	EB	WB	NB	SB	Total	EB	WB	NB	SB	Total	East	West	North	South	Total
2:00 PM	0	0	2	4	6	0	0	0	0	0	2	1	0	0	3
2:15 PM	0	0	5	3	8	0	0	0	0	0	1	0	0	0	1
2:30 PM	0	0	4	3	7	0	0	0	0	0	0	1	0	0	1
2:45 PM	0	0	2	5	7	0	0	0	0	0	0	0	0	0	0
3:00 PM	0	0	2	2	4	0	0	1	0	1	0	0	0	0	0
3:15 PM	0	0	7	2	9	0	0	0	0	0	0	1	0	0	1
3:30 PM	0	0	1	4	5	0	0	0	0	0	0	10	0	0	10
3:45 PM	0	0	1	3	4	0	0	0	0	0	0	76	0	0	76
Count Total	0	0	24	26	50	0	0	1	0	1	3	89	0	0	92
Peak Hr	0	0	11	11	22	0	0	1	0	1	0	87	0	0	87

Two-Hour Count Summaries - Heavy Vehicles																			
Interval Start	I-25 (Future Powers Blvd Alignment) On-Ramp				N/A				Voyager Pkwy				Voyager Pkwy				15-min Total	Rolling One Hour	
	Eastbound				Westbound				Northbound				Southbound						
	UT	LT	TH	RT	UT	LT	TH	RT	UT	LT	TH	RT	UT	LT	TH	RT			
2:00 PM	0	0	0	0	0	0	0	0	0	2	0	0	0	0	0	1	3	6	0
2:15 PM	0	0	0	0	0	0	0	0	0	2	3	0	0	0	0	2	1	8	0
2:30 PM	0	0	0	0	0	0	0	0	0	1	3	0	0	0	3	0	7	0	
2:45 PM	0	0	0	0	0	0	0	0	0	1	1	0	0	0	4	1	7	28	
3:00 PM	0	0	0	0	0	0	0	0	0	1	1	0	0	0	2	0	4	26	
3:15 PM	0	0	0	0	0	0	0	0	0	2	5	0	0	0	2	0	9	27	
3:30 PM	0	0	0	0	0	0	0	0	0	0	1	0	0	0	4	0	5	25	
3:45 PM	0	0	0	0	0	0	0	0	0	0	1	0	0	0	3	0	4	22	
Count Total	0	0	0	0	0	0	0	0	0	9	15	0	0	0	21	5	50	0	
Peak Hour	0	0	0	0	0	0	0	0	0	3	8	0	0	0	11	0	22	0	

Two-Hour Count Summaries - Bikes																		
Interval Start	I-25 (Future Powers Blvd Alignment) On-Ramp				N/A				Voyager Pkwy				Voyager Pkwy				15-min Total	Rolling One Hour
	Eastbound				Westbound				Northbound				Southbound					
	LT	TH	RT		LT	TH	RT		LT	TH	RT		LT	TH	RT			
2:00 PM	0	0	0		0	0	0		0	0	0		0	0	0		0	0
2:15 PM	0	0	0		0	0	0		0	0	0		0	0	0		0	0
2:30 PM	0	0	0		0	0	0		0	0	0		0	0	0		0	0
2:45 PM	0	0	0		0	0	0		0	0	0		0	0	0		0	0
3:00 PM	0	0	0		0	0	0		0	1	0		0	0	0		1	1
3:15 PM	0	0	0		0	0	0		0	0	0		0	0	0		0	1
3:30 PM	0	0	0		0	0	0		0	0	0		0	0	0		0	1
3:45 PM	0	0	0		0	0	0		0	0	0		0	0	0		0	1
Count Total	0	0	0		0	0	0		0	1	0		0	0	0		1	0
Peak Hour	0	0	0		0	0	0		0	1	0		0	0	0		1	0

Note: U-Turn volumes for bikes are included in Left-Turn, if any.

Location: 4 VOYAGER PKWY & I-25 ON RAMPS PM

Date: Tuesday, April 26, 2022

Peak Hour: 05:00 PM - 06:00 PM

Peak 15-Minutes: 05:15 PM - 05:30 PM

Peak Hour - All Vehicles

Peak Hour - Pedestrians/Bicycles on Crosswalk

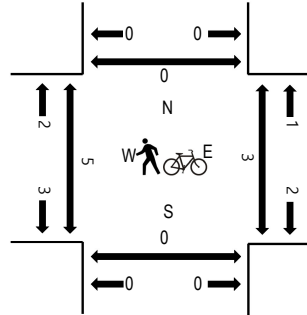
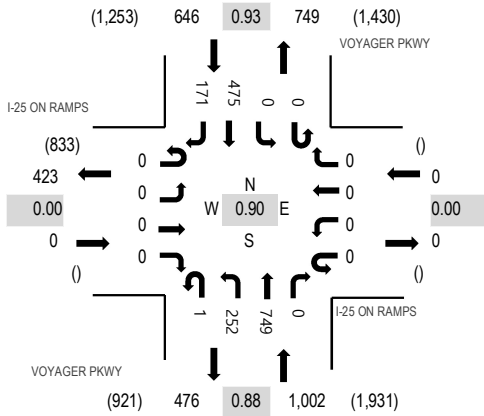

Note: Total study counts contained in parentheses.

Traffic Counts

Interval Start Time	I-25 ON RAMPS Eastbound				I-25 ON RAMPS Westbound				VOYAGER PKWY Northbound			VOYAGER PKWY Southbound				Total	Rolling Hour	Pedestrian Crossings					
	U-Turn	Left	Thru	Right	U-Turn	Left	Thru	Right	U-Turn	Left	Thru	Right	U-Turn	Left	Thru			Right	West	East	South	North	
4:00 PM	0	0	0	0	0	0	0	0	0	71	178	0	0	0	0	128	45	422	1,536	0	0	0	0
4:15 PM	0	0	0	0	0	0	0	0	0	65	139	0	0	0	0	100	30	334	1,516	22	0	0	0
4:30 PM	0	0	0	0	0	0	0	0	0	58	179	0	0	0	0	102	45	384	1,642	13	0	0	0
4:45 PM	0	0	0	0	0	0	0	0	1	53	185	0	0	0	0	114	43	396	1,642	0	0	0	0
5:00 PM	0	0	0	0	0	0	0	0	0	65	182	0	0	0	0	112	43	402	1,648	0	0	0	0
5:15 PM	0	0	0	0	0	0	0	0	1	68	217	0	0	0	0	126	48	460		0	0	0	0
5:30 PM	0	0	0	0	0	0	0	0	0	61	163	0	0	0	0	118	42	384		2	1	0	0
5:45 PM	0	0	0	0	0	0	0	0	0	58	187	0	0	0	0	119	38	402		2	2	0	0
Count Total	0	0	0	0	0	0	0	0	2	499	1,430	0	0	0	0	919	334	3,184		39	3	0	0
Peak Hour	0	0	0	0	0	0	0	0	1	252	749	0	0	0	0	475	171	1,648		4	3	0	0

Location: 5 VOYAGER PKWY & I-25 OFF RAMPS AM

Date: Tuesday, April 26, 2022

Peak Hour: 07:15 AM - 08:15 AM

Peak 15-Minutes: 07:30 AM - 07:45 AM

Peak Hour - All Vehicles

Peak Hour - Pedestrians/Bicycles on Crosswalk

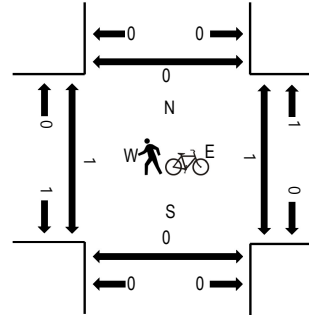
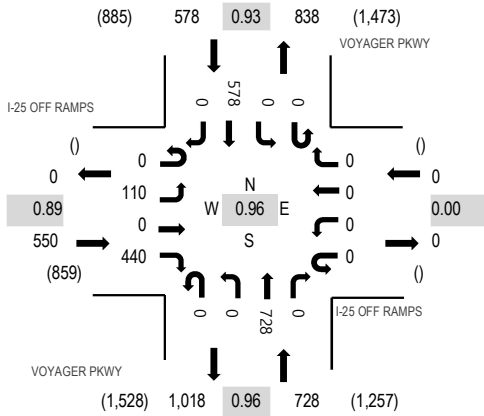

Note: Total study counts contained in parentheses.

Traffic Counts

Interval Start Time	I-25 OFF RAMPS Eastbound				I-25 OFF RAMPS Westbound				VOYAGER PKWY Northbound				VOYAGER PKWY Southbound				Total	Rolling Hour	Pedestrian Crossings			
	U-Turn	Left	Thru	Right	U-Turn	Left	Thru	Right	U-Turn	Left	Thru	Right	U-Turn	Left	Thru	Right			West	East	South	North
7:00 AM	0	14	0	67	0	0	0	0	0	0	107	0	0	0	72	0	260	1,681	0	0	0	0
7:15 AM	0	20	0	134	0	0	0	0	0	0	167	0	0	0	156	0	477	1,856	0	0	0	0
7:30 AM	0	24	0	127	0	0	0	0	0	0	189	0	0	0	142	0	482	1,678	0	0	0	0
7:45 AM	0	43	0	90	0	0	0	0	0	0	185	0	0	0	144	0	462	1,491	1	1	0	0
8:00 AM	0	23	0	89	0	0	0	0	0	0	187	0	0	0	136	0	435	1,320	0	0	0	0
8:15 AM	0	24	0	40	0	0	0	0	0	0	155	0	0	0	80	0	299		0	1	0	0
8:30 AM	0	33	0	40	0	0	0	0	0	0	134	0	0	0	88	0	295		1	0	0	0
8:45 AM	0	36	0	55	0	0	0	0	1	0	132	0	0	0	67	0	291		0	0	0	0
Count Total	0	217	0	642	0	0	0	0	1	0	1,256	0	0	0	885	0	3,001		2	2	0	0
Peak Hour	0	110	0	440	0	0	0	0	0	0	728	0	0	0	578	0	1,856		1	1	0	0

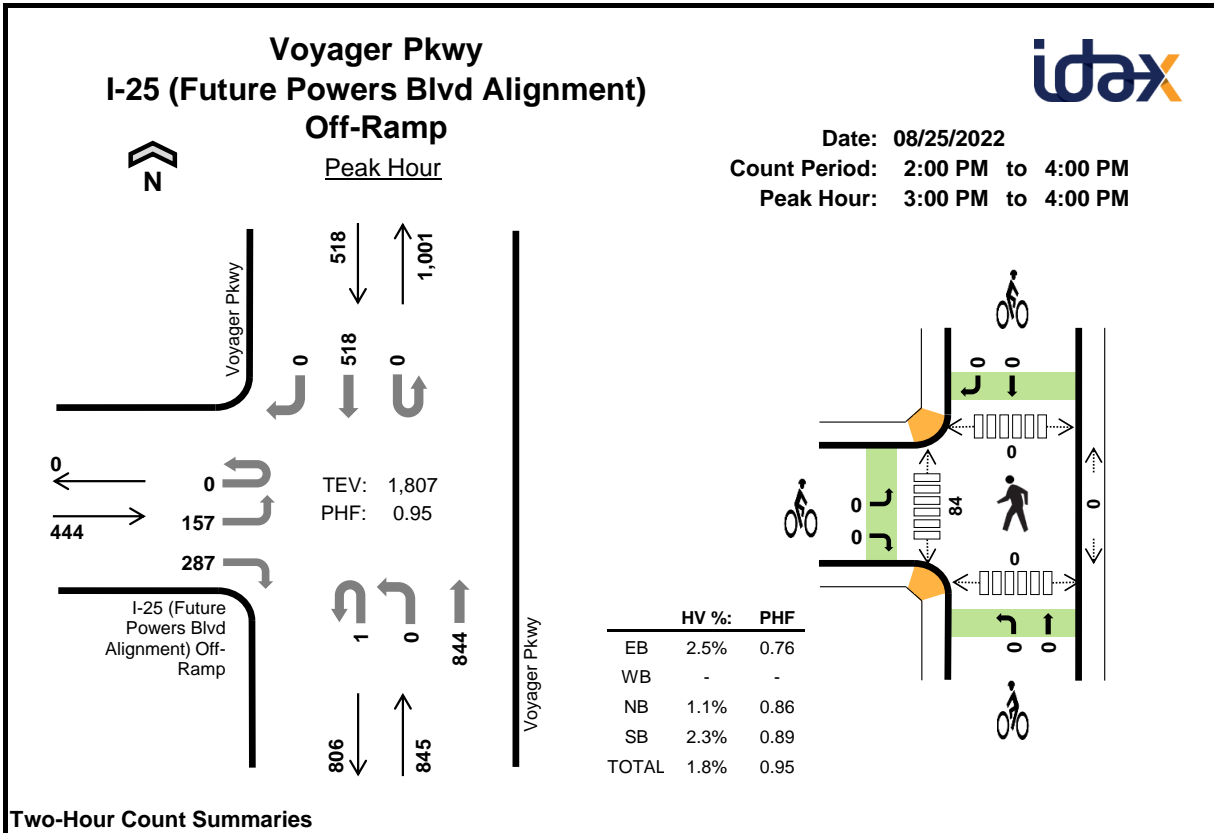

Two-Hour Count Summaries

Interval Start	I-25 (Future Powers Blvd Alignment) Off-Ramp				n/a				Voyager Pkwy				Voyager Pkwy				15-min Total	Rolling One Hour	
	Eastbound				Westbound				Northbound				Southbound						
	UT	LT	TH	RT	UT	LT	TH	RT	UT	LT	TH	RT	UT	LT	TH	RT			
2:00 PM	0	47	0	50	0	0	0	0	0	0	141	0	0	0	113	0	351	0	
2:15 PM	0	41	0	72	0	0	0	0	0	0	133	0	0	0	117	0	363	0	
2:30 PM	0	39	0	72	0	0	0	0	0	0	140	0	0	0	114	0	365	0	
2:45 PM	0	44	0	92	0	0	0	0	0	0	150	0	0	0	123	0	409	1,488	
3:00 PM	0	48	0	99	0	0	0	0	0	0	189	0	0	0	141	0	477	1,614	
3:15 PM	0	37	0	59	0	0	0	0	1	0	246	0	0	0	125	0	468	1,719	
3:30 PM	0	32	0	72	0	0	0	0	0	0	200	0	0	0	145	0	449	1,803	
3:45 PM	0	40	0	57	0	0	0	0	0	0	209	0	0	0	107	0	413	1,807	
Count Total	0	328	0	573	0	0	0	0	1	0	1,408	0	0	0	985	0	3,295	0	
Peak Hour	All	0	157	0	287	0	0	0	0	1	0	844	0	0	0	518	0	1,807	0
	HV	0	1	0	10	0	0	0	0	0	0	9	0	0	0	12	0	32	0
	HV%	-	1%	-	3%	-	-	-	-	0%	-	1%	-	-	-	2%	-	2%	0

Note: Two-hour count summary volumes include heavy vehicles but exclude bicycles in overall count.

Interval Start	Heavy Vehicle Totals					Bicycles					Pedestrians (Crossing Leg)				
	EB	WB	NB	SB	Total	EB	WB	NB	SB	Total	East	West	North	South	Total
2:00 PM	1	0	2	1	4	0	0	1	0	1	0	1	0	0	1
2:15 PM	4	0	4	1	9	0	0	1	0	1	0	0	0	0	0
2:30 PM	5	0	2	3	10	0	0	0	0	0	0	1	0	1	
2:45 PM	2	0	2	5	9	0	0	0	0	0	0	0	0	0	
3:00 PM	2	0	1	3	6	0	0	0	0	0	0	0	0	0	
3:15 PM	1	0	6	2	9	0	0	0	0	0	0	6	0	6	
3:30 PM	6	0	1	4	11	0	0	0	0	0	0	4	0	4	
3:45 PM	2	0	1	3	6	0	0	0	0	0	0	74	0	74	
Count Total	23	0	19	22	64	0	0	2	0	2	0	86	0	86	
Peak Hr	11	0	9	12	32	0	0	0	0	0	0	84	0	84	

Two-Hour Count Summaries - Heavy Vehicles																		
Interval Start	I-25 (Future Powers Blvd Alignment) Off-Ramp				n/a				Voyager Pkwy				Voyager Pkwy				15-min Total	Rolling One Hour
	Eastbound				Westbound				Northbound				Southbound					
	UT	LT	TH	RT	UT	LT	TH	RT	UT	LT	TH	RT	UT	LT	TH	RT		
2:00 PM	0	0	0	1	0	0	0	0	0	0	2	0	0	0	1	0	4	0
2:15 PM	0	1	0	3	0	0	0	0	0	0	4	0	0	0	1	0	9	0
2:30 PM	0	2	0	3	0	0	0	0	0	0	2	0	0	0	3	0	10	0
2:45 PM	0	0	0	2	0	0	0	0	0	0	2	0	0	0	5	0	9	32
3:00 PM	0	1	0	1	0	0	0	0	0	0	1	0	0	0	3	0	6	34
3:15 PM	0	0	0	1	0	0	0	0	0	0	6	0	0	0	2	0	9	34
3:30 PM	0	0	0	6	0	0	0	0	0	0	1	0	0	0	4	0	11	35
3:45 PM	0	0	0	2	0	0	0	0	0	0	1	0	0	0	3	0	6	32
Count Total	0	4	0	19	0	0	0	0	0	0	19	0	0	0	22	0	64	0
Peak Hour	0	1	0	10	0	0	0	0	0	0	9	0	0	0	12	0	32	0

Two-Hour Count Summaries - Bikes																		
Interval Start	I-25 (Future Powers Blvd Alignment) Off-Ramp				n/a				Voyager Pkwy				Voyager Pkwy				15-min Total	Rolling One Hour
	Eastbound				Westbound				Northbound				Southbound					
	LT	TH	RT		LT	TH	RT		LT	TH	RT		LT	TH	RT			
2:00 PM	0	0	0		0	0	0		0	1	0		0	0	0		1	0
2:15 PM	0	0	0		0	0	0		0	1	0		0	0	0		1	0
2:30 PM	0	0	0		0	0	0		0	0	0		0	0	0		0	0
2:45 PM	0	0	0		0	0	0		0	0	0		0	0	0		0	2
3:00 PM	0	0	0		0	0	0		0	0	0		0	0	0		0	1
3:15 PM	0	0	0		0	0	0		0	0	0		0	0	0		0	0
3:30 PM	0	0	0		0	0	0		0	0	0		0	0	0		0	0
3:45 PM	0	0	0		0	0	0		0	0	0		0	0	0		0	0
Count Total	0	0	0		0	0	0		0	2	0		0	0	0		2	0
Peak Hour	0	0	0		0	0	0		0	0	0		0	0	0		0	0

Note: U-Turn volumes for bikes are included in Left-Turn, if any.



ALL TRAFFIC DATA SERVICES

(303) 216-2439

www.alltrafficdata.net

Location: 5 VOYAGER PKWY & I-25 OFF RAMPS PM

Date: Tuesday, April 26, 2022

Peak Hour: 05:00 PM - 06:00 PM

Peak 15-Minutes: 05:15 PM - 05:30 PM

Peak Hour - All Vehicles

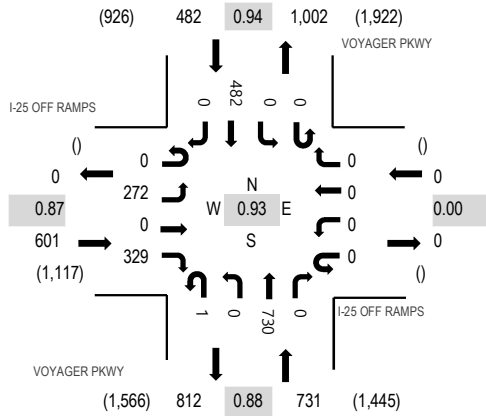

Peak Hour - Pedestrians/Bicycles on Crosswalk

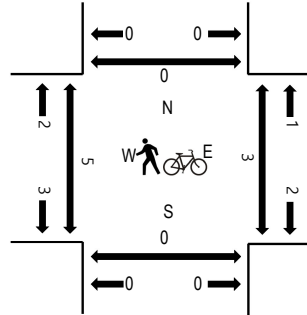

Note: Total study counts contained in parentheses.

Traffic Counts

Interval Start Time	I-25 OFF RAMPS Eastbound			I-25 OFF RAMPS Westbound			VOYAGER PKWY Northbound			VOYAGER PKWY Southbound				Total	Rolling Hour	Pedestrian Crossings						
	U-Turn	Left	Thru	Right	U-Turn	Left	Thru	Right	U-Turn	Left	Thru	Right	West			East	South	North				
4:00 PM	0	53	0	75	0	0	0	0	0	0	189	0	0	0	128	0	445	1,674	0	0	0	0
4:15 PM	0	36	0	79	0	0	0	0	0	0	166	0	0	0	101	0	382	1,671	18	0	0	0
4:30 PM	0	55	0	74	0	0	0	0	0	0	190	0	0	0	99	0	418	1,778	17	0	0	0
4:45 PM	0	62	0	82	0	0	0	0	0	0	169	0	0	0	116	0	429	1,784	0	0	0	0
5:00 PM	0	66	0	76	0	0	0	0	0	0	186	0	0	0	114	0	442	1,814	0	0	0	0
5:15 PM	0	68	0	76	0	0	0	0	1	0	216	0	0	0	128	0	489		0	0	0	0
5:30 PM	0	59	0	84	0	0	0	0	0	0	162	0	0	0	119	0	424		2	0	0	0
5:45 PM	0	79	0	93	0	0	0	0	0	0	166	0	0	0	121	0	459		2	0	0	0
Count Total	0	478	0	639	0	0	0	0	1	0	1,444	0	0	0	926	0	3,488		39	0	0	0
Peak Hour	0	272	0	329	0	0	0	0	1	0	730	0	0	0	482	0	1,814		4	0	0	0



ALL TRAFFIC DATA SERVICES

(303) 216-2439

www.alltrafficdata.net

Location: 6 VOYAGER PKWY & SPECTRUM LOOP (SOUTH) AM

Date: Tuesday, April 26, 2022

Peak Hour: 07:15 AM - 08:15 AM

Peak 15-Minutes: 07:30 AM - 07:45 AM

Peak Hour - All Vehicles

Peak Hour - Pedestrians/Bicycles on Crosswalk

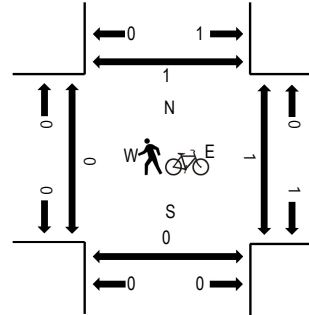
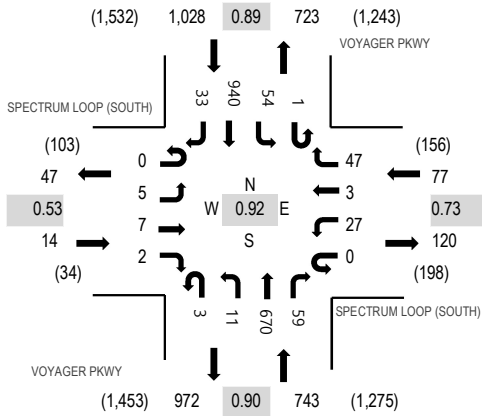

Note: Total study counts contained in parentheses.

Traffic Counts

Interval Start Time	SPECTRUM LOOP (SOUTH) Eastbound				SPECTRUM LOOP (SOUTH) Westbound			VOYAGER PKWY Northbound			VOYAGER PKWY Southbound				Total	Rolling Hour	Pedestrian Crossings					
	U-Turn	Left	Thru	Right	U-Turn	Left	Thru	Right	U-Turn	Left	Thru	Right	U-Turn	Left			Thru	Right	West	East	South	North
7:00 AM	0	0	0	0	0	6	2	5	0	2	103	6	0	3	122	12	261	1,688	0	0	0	0
7:15 AM	0	1	2	0	0	4	2	12	0	1	150	16	0	12	271	6	477	1,862	0	0	0	0
7:30 AM	0	2	1	0	0	7	0	12	2	2	184	19	0	14	255	8	506	1,685	0	1	0	0
7:45 AM	0	2	4	1	0	9	1	10	1	4	166	10	0	13	212	11	444	1,481	0	0	0	1
8:00 AM	0	0	0	1	0	7	0	13	0	4	170	14	1	15	202	8	435	1,309	0	0	0	0
8:15 AM	0	3	0	2	0	6	1	13	1	8	132	16	0	5	106	7	300		0	1	0	1
8:30 AM	0	1	0	4	0	14	0	17	0	3	122	16	0	7	114	4	302		1	0	0	0
8:45 AM	0	4	3	3	0	1	1	13	0	3	107	13	0	9	102	13	272		0	0	0	0
Count Total	0	13	10	11	0	54	7	95	4	27	1,134	110	1	78	1,384	69	2,997		1	2	0	2
Peak Hour	0	5	7	2	0	27	3	47	3	11	670	59	1	54	940	33	1,862		0	1	0	1

Voyager Parkway South Spectrum Loop



Date: 08/25/2022
 Count Period: 2:00 PM to 4:00 PM
 Peak Hour: 3:00 PM to 4:00 PM

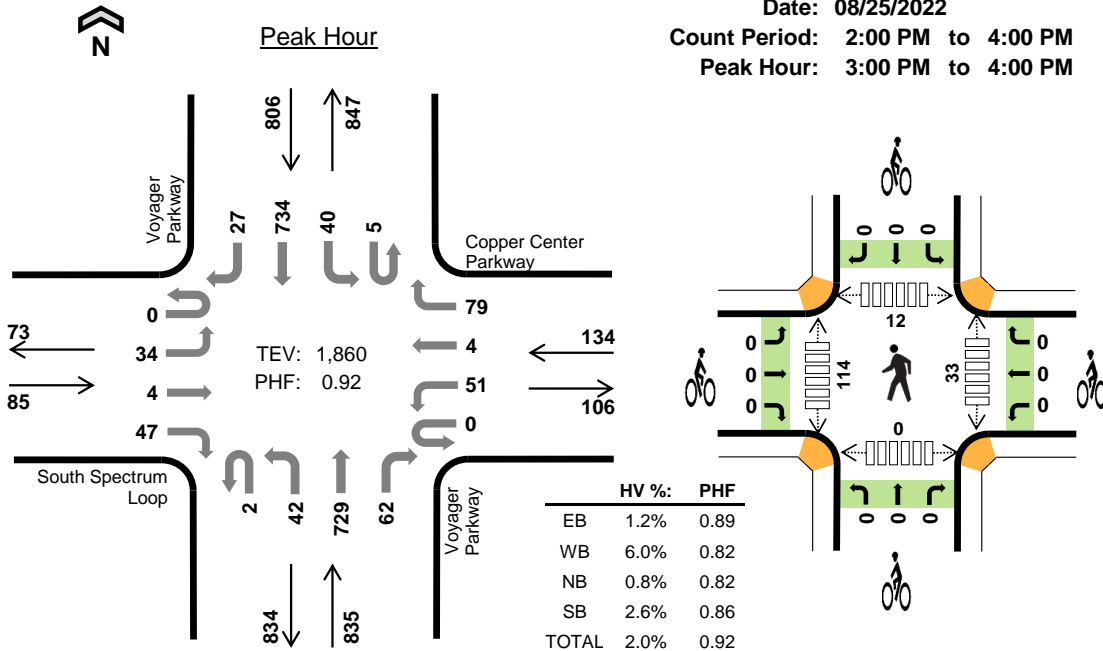

Two-Hour Count Summaries

Interval Start	South Spectrum Loop				Copper Center Parkway				Voyager Parkway				Voyager Parkway				15-min Total	Rolling One Hour	
	Eastbound		Westbound		Northbound		Southbound		UT	LT	TH	RT	UT	LT	TH	RT			
2:00 PM	0	9	2	12	0	10	2	20	0	10	109	13	0	11	131	15	344	0	
2:15 PM	0	11	2	7	0	4	2	14	1	4	109	11	1	14	170	9	359	0	
2:30 PM	0	9	1	6	0	10	3	15	1	5	118	6	0	12	166	6	358	0	
2:45 PM	0	11	4	9	0	3	1	9	1	6	127	11	0	13	194	12	401	1,462	
3:00 PM	0	8	2	10	0	14	2	18	1	6	159	15	2	11	210	11	469	1,587	
3:15 PM	0	7	0	12	0	15	1	20	0	10	225	20	2	10	174	8	504	1,732	
3:30 PM	0	9	2	11	0	14	0	27	1	15	159	15	0	12	195	8	468	1,842	
3:45 PM	0	10	0	14	0	8	1	14	0	11	186	12	1	7	155	0	419	1,860	
Count Total	0	74	13	81	0	78	12	137	5	67	1,192	103	6	90	1,395	69	3,322	0	
Peak Hour	All	0	34	4	47	0	51	4	79	2	42	729	62	5	40	734	27	1,860	0
	HV	0	0	1	0	0	4	0	4	0	1	5	1	0	2	19	0	37	0
	HV%	-	0%	25%	0%	-	8%	0%	5%	0%	2%	1%	2%	0%	5%	3%	0%	2%	0

Note: Two-hour count summary volumes include heavy vehicles but exclude bicycles in overall count.

Interval Start	Heavy Vehicle Totals					Bicycles					Pedestrians (Crossing Leg)				
	EB	WB	NB	SB	Total	EB	WB	NB	SB	Total	East	West	North	South	Total
2:00 PM	1	2	2	3	8	0	0	1	0	1	2	0	0	0	2
2:15 PM	0	2	3	3	8	0	0	0	0	0	1	1	0	0	2
2:30 PM	1	1	1	6	9	0	0	0	0	0	0	1	0	0	1
2:45 PM	0	0	3	6	9	0	0	0	0	0	5	0	0	0	5
3:00 PM	1	3	0	2	6	0	0	0	0	0	2	1	0	0	3
3:15 PM	0	2	5	4	11	0	0	0	0	0	23	33	8	0	64
3:30 PM	0	2	1	10	13	0	0	0	0	0	3	7	4	0	14
3:45 PM	0	1	1	5	7	0	0	0	0	0	5	73	0	0	78
Count Total	3	13	16	39	71	0	0	1	0	1	41	116	12	0	169
Peak Hour	1	8	7	21	37	0	0	0	0	0	33	114	12	0	159

Two-Hour Count Summaries - Heavy Vehicles																		
Interval Start	South Spectrum Loop				Copper Center Parkway				Voyager Parkway				Voyager Parkway				15-min Total	Rolling One Hour
	Eastbound				Westbound				Northbound				Southbound					
	UT	LT	TH	RT	UT	LT	TH	RT	UT	LT	TH	RT	UT	LT	TH	RT		
2:00 PM	0	0	0	1	0	1	0	1	0	1	1	0	0	0	3	0	8	0
2:15 PM	0	0	0	0	0	0	1	1	0	0	3	0	0	1	2	0	8	0
2:30 PM	0	0	0	1	0	0	0	1	0	0	1	0	0	0	5	1	9	0
2:45 PM	0	0	0	0	0	0	0	0	0	0	2	1	0	2	4	0	9	34
3:00 PM	0	0	1	0	0	2	0	1	0	0	0	0	0	1	1	0	6	32
3:15 PM	0	0	0	0	0	0	0	2	0	0	4	1	0	0	4	0	11	35
3:30 PM	0	0	0	0	0	1	0	1	0	1	0	0	0	0	10	0	13	39
3:45 PM	0	0	0	0	0	1	0	0	0	0	1	0	0	1	4	0	7	37
Count Total	0	0	1	2	0	5	1	7	0	2	12	2	0	5	33	1	71	0
Peak Hour	0	0	1	0	0	4	0	4	0	1	5	1	0	2	19	0	37	0
Two-Hour Count Summaries - Bikes																		
Interval Start	South Spectrum Loop			Copper Center Parkway			Voyager Parkway			Voyager Parkway			15-min Total	Rolling One Hour				
	Eastbound			Westbound			Northbound			Southbound								
	LT	TH	RT	LT	TH	RT	LT	TH	RT	LT	TH	RT						
2:00 PM	0	0	0	0	0	0	0	0	0	0	1	0	0	0	0	1	0	
2:15 PM	0	0	0	0	0	0	0	0	0	0	0	0	0	0	0	0	0	
2:30 PM	0	0	0	0	0	0	0	0	0	0	0	0	0	0	0	0	0	
2:45 PM	0	0	0	0	0	0	0	0	0	0	0	0	0	0	0	0	1	
3:00 PM	0	0	0	0	0	0	0	0	0	0	0	0	0	0	0	0	0	
3:15 PM	0	0	0	0	0	0	0	0	0	0	0	0	0	0	0	0	0	
3:30 PM	0	0	0	0	0	0	0	0	0	0	0	0	0	0	0	0	0	
3:45 PM	0	0	0	0	0	0	0	0	0	0	0	0	0	0	0	0	0	
Count Total	0	0	0	0	0	0	0	0	0	0	1	0	0	0	0	1	0	
Peak Hour	0	0	0	0	0	0	0	0	0	0	0	0	0	0	0	0	0	
<i>Note: U-Turn volumes for bikes are included in Left-Turn, if any.</i>																		

Location: 6 VOYAGER PKWY & SPECTRUM LOOP (SOUTH) PM

Date: Tuesday, April 26, 2022

Peak Hour: 04:30 PM - 05:30 PM

Peak 15-Minutes: 05:15 PM - 05:30 PM

Peak Hour - All Vehicles

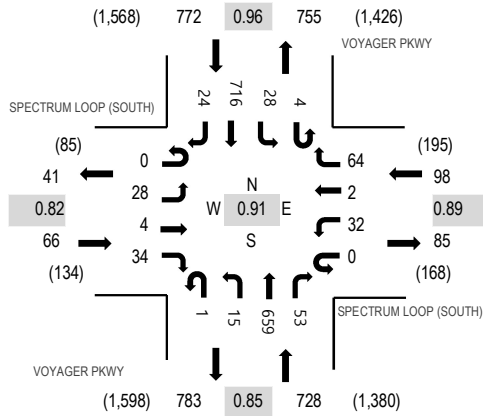

Note: Total study counts contained in parentheses.

Peak Hour - Pedestrians/Bicycles on Crosswalk

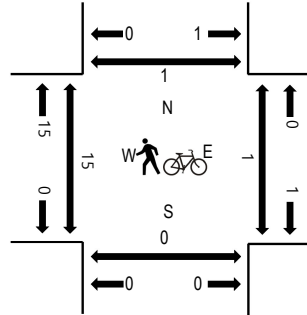

Traffic Counts

Interval Start Time	SPECTRUM LOOP (SOUTH) Eastbound				SPECTRUM LOOP (SOUTH) Westbound				VOYAGER PKWY Northbound				VOYAGER PKWY Southbound				Total	Rolling Hour	Pedestrian Crossings			
	U-Turn	Left	Thru	Right	U-Turn	Left	Thru	Right	U-Turn	Left	Thru	Right	U-Turn	Left	Thru	Right			West	East	South	North
4:00 PM	0	13	2	9	0	13	0	14	0	8	157	16	0	10	192	5	439	1,628	0	0	0	0
4:15 PM	0	5	0	8	0	14	0	10	0	14	148	9	1	13	164	4	390	1,598	16	1	0	0
4:30 PM	0	5	1	6	0	10	1	10	0	6	172	15	1	4	156	9	396	1,664	15	0	0	0
4:45 PM	0	8	0	7	0	8	0	20	0	0	138	20	2	7	189	4	403	1,657	0	1	0	1
5:00 PM	0	10	2	10	0	10	0	20	1	2	155	6	0	6	182	5	409	1,649	0	0	0	0
5:15 PM	0	5	1	11	0	4	1	14	0	7	194	12	1	11	189	6	456		0	0	0	0
5:30 PM	0	13	0	5	0	11	0	19	0	7	127	11	0	11	184	1	389		4	0	0	1
5:45 PM	0	5	1	7	0	6	0	10	0	2	149	4	0	6	202	3	395		2	2	0	1
Count Total	0	64	7	63	0	76	2	117	1	46	1,240	93	5	68	1,458	37	3,277		37	4	0	3
Peak Hour	0	28	4	34	0	32	2	64	1	15	659	53	4	28	716	24	1,664		15	1	0	1

Voyager and Spectrum North

Time	Total	Peak Hour
12:00am	13	
12:15am	7	
12:30am	5	
12:45am	4	28
1:00am	3	19
1:15am	3	14
1:30am	3	12
1:45am	1	10
2:00am	1	8
2:15am	1	6
2:30am	2	6
2:45am	2	7
3:00am	1	6
3:15am	1	5
3:30am	1	4
3:45am	2	5
4:00am	2	7
4:15am	2	8
4:30am	4	10
4:45am	5	13
5:00am	5	16
5:15am	8	22
5:30am	15	34
5:45am	33	61
6:00am	35	91
6:15am	49	132
6:30am	90	207
6:45am	147	321
7:00am	280	566
7:15am	553	1070
7:30am	445	1425
7:45am	347	1625
8:00am	242	1586
8:15am	176	1210
8:30am	182	947
8:45am	157	757
9:00am	151	666
9:15am	192	682
9:30am	182	682
9:45am	179	704
10:00am	189	742
10:15am	170	720
10:30am	181	719
10:45am	201	741

11:00am	237	789
11:15am	234	853
11:30am	229	901
11:45am	258	958
12:00pm	285	1006
12:15pm	278	1051
12:30pm	289	1110
12:45pm	290	1142
1:00pm	270	1127
1:15pm	244	1093
1:30pm	225	1029
1:45pm	228	968
2:00pm	225	923
2:15pm	242	921
2:30pm	294	989
2:45pm	450	1211
3:00pm	382	1367
3:15pm	491	1616
3:30pm	420	1742
3:45pm	417	1709
4:00pm	362	1689
4:15pm	398	1597
4:30pm	384	1561
4:45pm	386	1531
5:00pm	428	1597
5:15pm	434	1633
5:30pm	421	1669
5:45pm	401	1684
6:00pm	377	1632
6:15pm	366	1565
6:30pm	305	1449
6:45pm	282	1330
7:00pm	266	1219
7:15pm	233	1085
7:30pm	220	1000
7:45pm	217	936
8:00pm	192	862
8:15pm	182	812
8:30pm	163	755
8:45pm	151	688
9:00pm	139	635
9:15pm	132	585
9:30pm	120	542
9:45pm	95	486
10:00pm	67	414
10:15pm	53	335
10:30pm	39	254

10:45pm	33	192
11:00pm	28	153
11:15pm	20	120
11:30pm	17	99
11:45pm	14	80
Grand Total	17186	

APPENDIX B

Future Traffic Projections/Background Studies

ROUTE	REFPT	ENDREFPT	LENGTH	AADT	AADTYR	YR20FACTOR	GROWTH RATE	DHV	LOCATION
083A	21.241	23.127	1.877	15000	2020	1.78	2.9%	10	ON SH 83 S/O NORTH GATE RD



LSC TRANSPORTATION CONSULTANTS, INC.
2504 East Pikes Peak Avenue, Suite 304
Colorado Springs, CO 80909
(719) 633-2868
FAX (719) 633-5430
E-mail: lsc@lsctrans.com
Website: <http://www.lsctrans.com>

March 18, 2022

Bob H. Yoo, P.E.
Executive Consulting Engineers, Inc.
13540 Meadowgrass Drive, Suite 200
Colorado Springs, CO 80921

RE: Polaris Pointe South
Filing No. 4
Trip Generation Memorandum
Colorado Springs, Colorado
LSC #S224110

Dear Bob:

In response to your request LSC Transportation Consultants, Inc. has prepared this trip generation comparison memorandum for Filing No. 4 of the Polaris Pointe South development. The Polaris Pointe South development is located west of Voyager Parkway and south of Powers Boulevard. This report contains the projected vehicle-trip generation for the proposed development and a comparison to the trip-generation estimates assumed for this area in previous reports completed by LSC.

SITE DEVELOPMENT AND LAND USE

Currently-Proposed Land Use

The 18.713-acre Filing No. 4 site is located on the southwest bend of Spectrum Loop. The site is planned to be developed with an outdoor amphitheater, five restaurant “pad” sites, and a 300-space parking facility. It is anticipated that the restaurant site “end users” will be fine-dining-type establishments. Note: Filing 4 also includes a portion of the internal street network – for connectivity and circulation.

The outdoor amphitheater is planned to have a capacity of 6,000 attendees. The venue will host seasonal weekly concerts on Friday and Saturday nights from June to September. Concerts will typically be 90 to 120 minutes long starting with an opening act around 6:30 p.m. and a feature act around 8:45 p.m. The peak arrival hour for attendees is anticipated to occur between 5:00 and 6:00 p.m. For the first three years, overflow parking is planned on the vacant parcel located just east of the Filing No. 4 site. In the future once the areas to the east are developed, the venue plans to utilize off-site shuttle parking lots and operate shuttle buses (multiple coach-size buses)

**Table 1
Trip Generation Estimate
Polaris Pointe South Filing No. 4**

Land Use Code	Land Use Description	Trip Generation Units	Trip Generation Rates ⁽¹⁾						Total Trips Generated				
			Monday through Thursday						Monday through Thursday ⁽²⁾				
			Average Weekday Traffic	Morning Peak Hour		Afternoon Peak Hour		Average Weekday Traffic	Morning Peak Hour		Afternoon Peak Hour		
			In	Out	In	Out	In	Out	In	Out			
---	Amphitheater	6,000 seats	---	---	---	---	---	50	10	5	5	20	
931	Fine Dining Restaurant ⁽³⁾	45 KSF ⁽⁴⁾	83.84	0.37	0.37	5.23	2.57	3,773	16	16	235	116	
								3,823	26	21	240	136	

Notes:

(1) Source: *Trip Generation, Institute of Transportation Engineers*, 11th Edition, 2021.

(2) See Table 2 for event day trip generation estimate

(3) Note: ITE Estimate - Does not include internal capture trips due to restaurant patrons with the primary trip purpose of attending a concert at the proposed amphitheater

(4) KSF = thousand square feet of floor space

Source: LSC Transportation Consultants, Inc.

Mar-22

Table 3
Study Area Trip Generation Estimate
Weekdays (Monday thru Thursday) Summer Season
Polaris Pointe South Filing No. 4

Parcel	Status	Land Use Code	Land Use Description	Trip Generation Units	KSF ⁽³⁾	Trip Generation Rates ⁽¹⁾					Total Trips Generated					Internal Trips ⁽²⁾ (%)	Internal Trips Generated					External Trips Generated					
						Average Weekday Traffic	Morning Peak Hour	Afternoon Peak Hour	Average Weekday Traffic	Morning Peak Hour	Afternoon Peak Hour	Average Weekday Traffic	Morning Peak Hour	Afternoon Peak Hour	Average Weekday Traffic		Morning Peak Hour	Afternoon Peak Hour	Average Weekday Traffic	Morning Peak Hour	Afternoon Peak Hour						
Polaris Pointe Shops Fil No. 1	Lot 1	Existing	821 Shopping Plaza (40-150 KSF No Supermarket)	18.5	KSF ⁽³⁾	67.52	1.07	0.66	2.54	2.65	1,249	20	12	47	49	2%	25	0	0	1	1	1,224	20	12	46	48	
	Lot 2	Existing	821 Shopping Plaza (40-150 KSF No Supermarket)	12	KSF	67.52	1.07	0.66	2.54	2.65	810	13	8	31	32	2%	16	0	0	1	1	794	13	8	30	31	
Polaris Pointe Shops Fil No. 1a	Lot 1	Future	821 Shopping Plaza (40-150 KSF No Supermarket)	10	KSF	45.66	0.64	0.39	1.99	2.16	457	6	4	20	22	2%	9	0	0	0	0	448	6	4	20	22	
	Lot 2	Approved	912 Drive-in Bank	3.5	KSF	100.35	5.77	4.18	10.51	10.51	351	20	15	37	37	2%	7	0	0	1	1	344	20	15	36	36	
	Lot 3	Approved	934 Fast-Food Restaurant with Drive-Through Window	3.5	KSF	467.48	22.75	21.86	17.18	15.85	1,636	80	77	60	55	5%	82	4	4	3	3	1,554	76	73	57	52	
Polaris Pointe Shops Fil No. 2	Lot 1	Existing	821 Shopping Plaza (40-150 KSF No Supermarket)	3	KSF	67.52	1.07	0.66	2.54	2.65	203	3	2	8	8	2%	4	0	0	0	0	199	3	2	8	8	
Polaris Pointe South Filing No. 3	Lots 1 & 2	Future	821 Shopping Plaza (40-150 KSF No Supermarket)	45	KSF	67.52	1.07	0.66	2.54	2.65	3,038	48	30	114	119	2%	61	1	1	2	2	2,977	47	29	112	117	
Polaris Junction Sub Fil 1	Lot 1	Approved	220 Multifamily Housing (Low-Rise)	301	DU ⁽⁴⁾	7.42	0.10	0.35	0.33	0.19	2,235	31	105	99	58	5%	112	2	5	5	3	2,123	29	100	94	55	
Polaris Pointe South Filing No. 4	Lot 1	SITE	--- Amphitheater	6,000	seats	---	---	---	---	---	50	10	5	5	20	2%	1	0	0	0	0	49	10	5	5	20	
	Lots 2-6		931 Fine Dining Restaurant	45	KSF	83.84	0.37	0.37	5.23	2.57	3,773	16	16	235	116	1%	38	0	0	2	1	3,735	16	16	233	115	
6207300001 & 6207100012		Future	820 Shopping Center (>150 KSF)	300	KSF	45.66	0.64	0.39	1.99	2.16	13,697	193	118	597	647	2%	274	4	2	12	13	13,423	189	116	585	634	
			930 Fast Casual Restaurant	8	KSF	97.14	0.72	0.72	8.78	7.19	777	6	6	70	57	5%	39	0	0	4	3	738	6	6	66	54	
			932 High-Turnover (Sit-Down) Restaurant	10	KSF	107.20	5.26	4.31	5.52	3.53	1,072	53	43	55	35	5%	54	3	2	3	2	1,018	50	41	52	33	
			934 Fast-Food Restaurant with Drive-Through Window	7	KSF	467.48	22.75	21.86	17.18	15.85	3,272	159	153	120	111	5%	164	8	8	6	6	3,108	151	145	114	105	
6200000710	Approved	220 Multifamily Housing (Low-Rise)	240	DU	7.39	0.11	0.35	0.34	0.20	1,774	25	84	81	48	5%	89	1	4	4	2	1,685	24	80	77	46		
						34,394	683	678	1,579	1,414						975	23	26	44	38	33,419	660	652	1,535	1,376		
Trip Generation Estimate From The Copper Ridge at Northgate Traffic Impact Study by LSC September 2, 2009																											
TAZ 2			820 Shopping Center	1,031	KSF	23.36	0.27	0.17	1.14	1.19	24,081	277	177	1,175	1,223	2%	482	5	3	24	25	23,599	272	174	1,151	1,198	
			445 Multiplex Movie Theater (Friday)	5,000	seats	1.27	0.00	0.00	0.06	0.04	6,350	0	0	300	200	2%	127	0	0	6	4	6,223	0	0	294	196	
			310 Hotel	249	rooms	8.17	0.34	0.22	0.31	0.28	2,034	85	54	78	69	15%	305	13	8	12	10	1,729	72	46	66	59	
			710 General Office Building	200	KSF	11.01	1.36	0.19	0.25	1.24	2,202	273	37	51	247	5%	110	14	2	3	12	2,092	259	35	48	235	
						34,667	635	268	1,604	1,739						1,024	32	13	45	51	33,643	603	255	1,559	1,688		
Change in Trip Generation Estimate						-273	48	410	-25	-325						-49	-9	13	-1	-13	-224	57	397	-24	-312		

Notes:
(1) Source: *Trip Generation, Institute of Transportation Engineers*, 11th Edition, 2021.
(2) Estimate by LSC
(3) KSF = thousand square feet of floor space
(4) DU = dwelling units

**Table 1
Trip Generation Estimate
Polaris Pointe South Filing No. 4**

Land Use Code	Land Use Description	Trip Generation Units	Trip Generation Rates ⁽¹⁾							Total Trips Generated						
			Average Weekday Traffic	Midweek		Afternoon		Friday Afternoon		Monday through Thursday			Friday Afternoon			
				In	Out	In	Out	In	Out	Average Weekday Traffic	Morning Peak Hour	Afternoon Peak Hour	In	Out	In	Out
---	Amphitheater	6,000 seats	---	---	---	---	---	---	---	---	50	10	5	5	20	See Table 3
931	Fine Dining Restaurant ⁽³⁾	45 KSF	83.84	0.37	0.37	5.23	2.57	5.23	2.57	3,773	16	16	235	116	235	116
										3,823	26	21	240	136		

Notes:
(1) Source: *Trip Generation, Institute of Transportation Engineers*, 11th Edition, 2021.
(2) KSF = thousand square feet of floor space
(3) Note: ITE Estimate - Does not include internal capture trips due to restaurant patrons with the primary trip purpose of attending a concert at the proposed amphitheater

Source: LSC Transportation Consultants, Inc. Feb-21 Feb-21

Table 2
Study Area Trip Generation Estimate
Weekdays (Monday thru Thursday) Summer Season
Polaris Pointe South Filing No. 4

Parcel	Status	Land Use Code	Land Use Description	Trip Generation Units		Trip Generation Rates ⁽¹⁾					Total Estimated Existing Trips Generated					
						Average Weekday Traffic	Morning Peak Hour In	Out	Afternoon Peak Hour In	Out	Average Weekday Traffic	Morning Peak Hour In	Out	Afternoon Peak Hour In	Out	
Polaris Pointe Shops Fil No. 1	Lot 1	Existing	821	Shopping Plaza (40-150 KSF No Supermarket)	18.5	KSF ⁽²⁾	67.52	1.07	0.66	2.54	2.65	1,249	20	12	47	49
	Lot 2	Existing	821	Shopping Plaza (40-150 KSF No Supermarket)	12	KSF	67.52	1.07	0.66	2.54	2.65	810	13	8	31	32
Polaris Pointe Shops Fil No. 1a	Lot 1	Future	822	Strip Retail Plaza (<40 KSF)	10	KSF	45.66	0.64	0.39	1.99	2.16	457	6	4	20	22
	Lot 2	Approved	912	Drive-in Bank	3.5	KSF	100.35	5.77	4.18	10.51	10.51	351	20	15	37	37
	Lot 3	Approved	934	Fast-Food Restaurant with Drive-Through Window	3.5	KSF	467.48	22.75	21.86	17.18	15.85	1,636	80	77	60	55
Polaris Pointe Shops Fil No. 2	Lot 1	Existing	821	Shopping Plaza (40-150 KSF No Supermarket)	3	KSF	67.52	1.07	0.66	2.54	2.65	203	3	2	8	8
Polaris Pointe South Filing No. 3	Lots 1 & 2	Future	821	Shopping Plaza (40-150 KSF No Supermarket)	45	KSF	67.52	1.07	0.66	2.54	2.65	3,038	48	30	114	119
Polaris Junction Sub Fil 1	Lot 1	Approved	220	Multifamily Housing (Low-Rise)	301	DU ⁽³⁾	7.42	0.10	0.35	0.33	0.19	2,235	31	105	99	58
Polaris Pointe South Filing No. 4	Lot 1	SITE	---	Amphitheater	6,000	seats						50	10	5	5	20
	Lots 2-6	SITE	931	Fine Dining Restaurant ⁽³⁾	45	KSF	83.84	0.37	0.37	5.23	2.57	3,773	16	16	235	116
6207300001 & 6207100012		Future	820	Shopping Center (>150 KSF)	300	KSF	45.66	0.64	0.39	1.99	2.16	13,697	193	118	597	647
			930	Fast Casual Restaurant	8	KSF	97.14	0.72	0.72	8.78	7.19	777	6	6	70	57
			932	High-Turnover (Sit-Down) Restaurant	10	KSF	107.20	5.26	4.31	5.52	3.53	1,072	53	43	55	35
			934	Fast-Food Restaurant with Drive-Through Window	7	KSF	467.48	22.75	21.86	17.18	15.85	3,272	159	153	120	111
6200000710	Approved	220	Multifamily Housing (Low-Rise)	240	DU	7.39	0.11	0.35	0.34	0.20	1,774	25	84	81	48	
											34,394	683	677	1,579	1,415	
Trip Generation Estimate From The Copper Ridge at Northgate Traffic Impact Study by LSC September 2, 2009																
TAZ 2			820	Shopping Center	1,031	KSF	23.36	0.27	0.17	1.14	1.19	24,081	277	177	1,175	1,223
			445	Multiplex Movie Theater (Friday)	5,000	seats	1.27	0.00	0.00	0.06	0.04	6,350	0	0	300	200
			310	Hotel	249	rooms	8.17	0.34	0.22	0.31	0.28	2,034	85	54	78	69
			710	General Office Building	200	KSF	11.01	1.36	0.19	0.25	1.24	2,202	273	37	51	247
											34,667	635	268	1,604	1,739	
Change in Trip Generation Estimate											-273	48	409	-25	-324	

Notes:

(1) Source: *Trip Generation, Institute of Transportation Engineers*, 11th Edition, 2021.

(2) KSF = thousand square feet of floor space

(3) DU = dwelling units

Source: LSC Transportation Consultants, Inc.



Traffic Impact Study

Polaris Junction

Colorado Springs, Colorado

Prepared for:

The Blackburn Group, LLC

Kimley»»Horn



T R A F F I C I M P A C T S T U D Y

Polaris Junction

Colorado Springs, Colorado

Prepared for
The Blackburn Group, LLC
2088 Old Taylor Road
Oxford, Mississippi 38655

Prepared by
Kimley-Horn and Associates, Inc.
4582 South Ulster Street
Suite 1500
Denver, Colorado 80237
(303) 228-2300



January 2020

This document, together with the concepts and designs presented herein, as an instrument of service, is intended only for the specific purpose and client for which it was prepared. Reuse of and improper reliance on this document without written authorization and adaptation by Kimley-Horn and Associates, Inc. shall be without liability to Kimley-Horn and Associates, Inc.

4.0 PROJECT TRAFFIC CHARACTERISTICS

4.1 Trip Generation

Site-generated traffic estimates are determined through a process known as trip generation. Rates and equations are applied to the proposed land use to estimate traffic generated by the development during a specific time interval. The acknowledged source for trip generation rates is the *Trip Generation Manual*¹ published by the Institute of Transportation Engineers (ITE). ITE has established trip rates in nationwide studies of similar land uses. For this study, Kimley-Horn used the ITE Trip Generation Report fitted curve equations that apply to Mid-Rise Multifamily Housing (ITE Code 221) for traffic associated with the development.

Polaris Junction is expected to generate approximately 1,640 daily weekday trips, with 101 of these trips occurring during the morning peak hour and 128 trips occurring during the afternoon peak hour. Calculations were based on the procedure and information provided in the ITE *Trip Generation Handbook, 3rd Edition, 2017*. **Table 1** summarizes the estimated trip generation for the proposed development. The trip generation worksheet is included in **Appendix C**.

Table 1 – Polaris Junction Project Traffic Generation

Land Use and Quantity	Daily	Weekday Vehicle Trips					
		AM Peak Hour			PM Peak Hour		
		In	Out	Total	In	Out	Total
Mid-Rise Multifamily Housing (ITE 221) – 301 Dwelling Units	1,640	26	75	101	78	50	128

4.2 Trip Distribution

Distribution of project traffic on the street system was based on the area street system characteristics, existing traffic patterns, existing and anticipated surrounding development areas, and the proposed access system for the project. The directional distribution of traffic is a means to quantify the percentage of site-generated traffic that approaches the site from a given direction and departs the site back to the original source. The project trip distribution is illustrated in **Figure 7**.

¹ Institute of Transportation Engineers, *ITE Trip Generation Manual*, Tenth Edition, Washington DC, 2017.

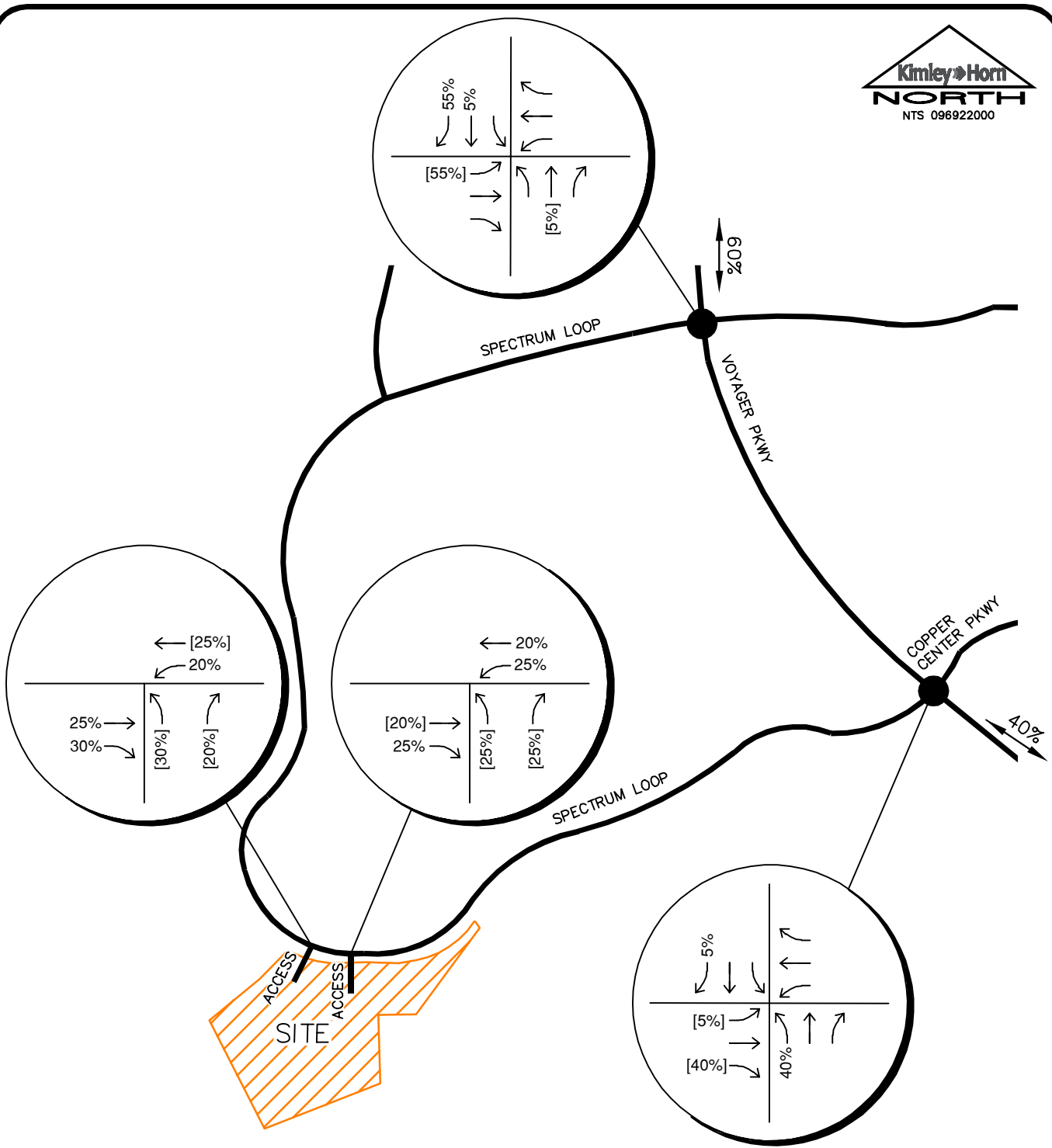

LEGEND

- Study Area Key Intersection
- XX% External Trip Distribution Percentage
- XX%[XX%] Entering[Exiting] Trip Distribution Percentage

POLARIS JUNCTION
 PROJECT TRIP DISTRIBUTION

FIGURE 7

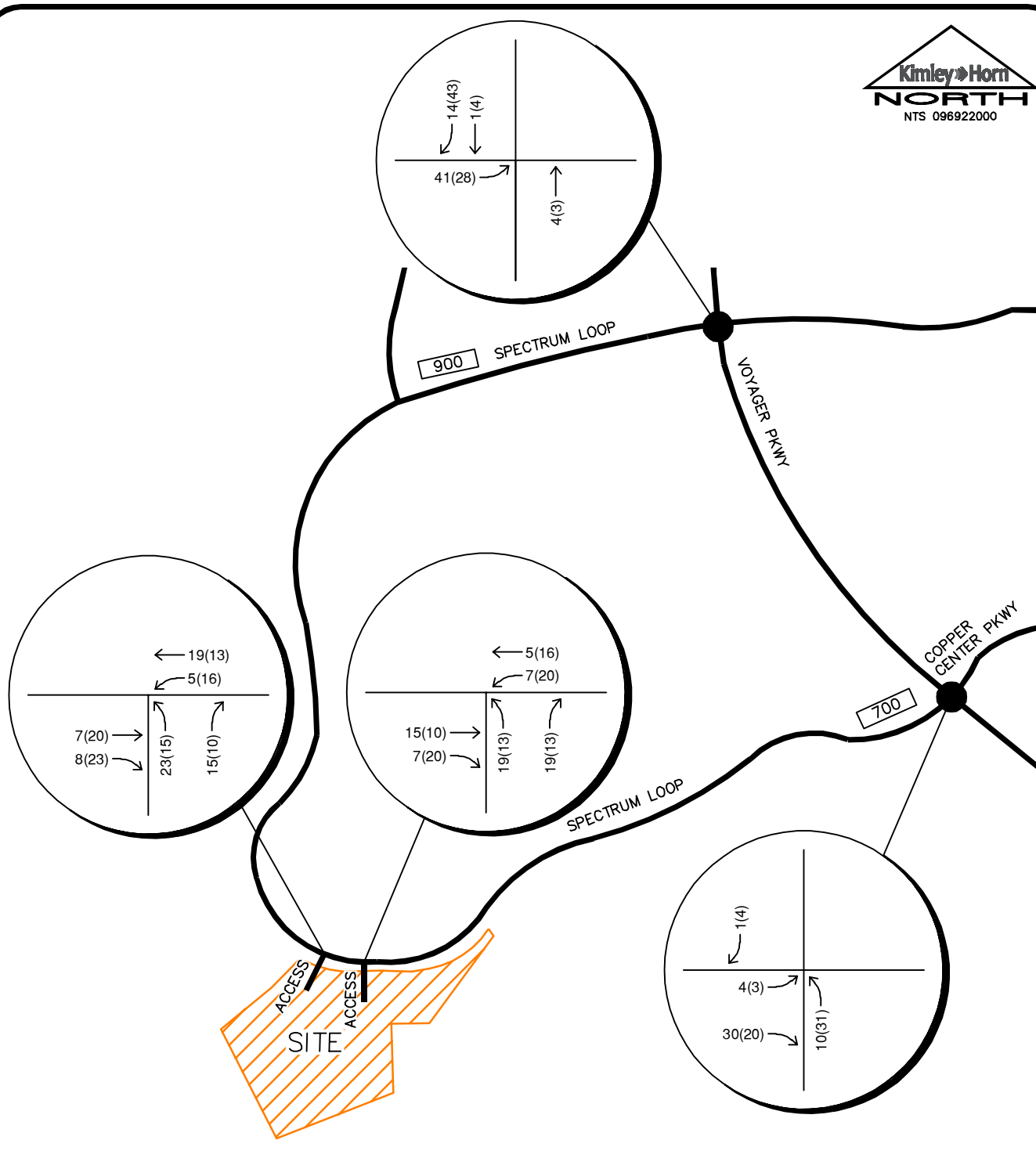

LEGEND

- Study Area Key Intersection
- XXX(XXX) Weekday AM(PM) Peak Hour Traffic Volumes
- XX,X00 Estimated Daily Traffic Volume

POLARIS JUNCTION
 PROJECT TRAFFIC ASSIGNMENT

FIGURE 8

Project Polaris Junction
 Subject Trip Generation for Multifamily Housing (Mid-Rise)
 Designed by KLT Date January 20, 2020 Job No. 96922000.0
 Checked by _____ Date _____ Sheet No. 1 of 1

TRIP GENERATION MANUAL TECHNIQUES

ITE Trip Generation Manual 10th Edition, Fitted Curve Equations

Land Use Code - Multifamily Housing (Mid-Rise) (221)

Independent Variable - Dwelling Units (X)

$$X = 301$$

T = Average Vehicle Trip Ends

Peak Hour of Adjacent Street Traffic, One Hour Between 7 and 9 a.m. (Series 200 Page 74)

$\ln(T) = 0.98 \ln(X) - 0.98$	Directional Distribution:	26% ent.	74% exit.
$\ln(T) = 0.98 * \ln(301.0) - 0.98$	T = 101	Average Vehicle Trip Ends	
	26 entering	75	exiting
	26 + 75	=	101

Peak Hour of Adjacent Street Traffic, One Hour Between 4 and 6 p.m. (Series 200 Page 75)

$\ln(T) = 0.96 \ln(X) - 0.63$	Directional Distribution:	61% ent.	39% exit.
$\ln(T) = 0.96 * \ln(301.0) - 0.63$	T = 128	Average Vehicle Trip Ends	
	78 entering	50	exiting
	78 + 50	=	128

Weekday (Series 200 Page 73)

$(T) = 5.45*(X) - 1.75$	Directional Distribution:	50% ent.	50% exit.
$(T) = 5.45 * 301 - 1.75$	T = 1639	Average Vehicle Trip Ends	
	818 entering	820	exiting
	818 + 820	=	not ok

Peak Hour of Generator, Saturday (Series 200 Page 79)

$(T) = 0.42*(X) + 6.73$	Directional Distribution:	49% ent.	51% exit.
$(T) = 0.42 * 301 + 6.73$	T = 133	Average Vehicle Trip Ends	
	65 entering	68	exiting
	65 + 68	=	133

Springs at Northgate

Traffic Impact Study

Prepared for:

Erin Conway
Development Associate
Continental Properties
W134N8675 Executive Parkway
Menomonee Falls, WI 53051

MARCH 19, 2021

LSC Transportation Consultants
Prepared by: Jeffrey C. Hodsdon, P.E.

LSC #S214140



Table 1: Estimated External Site Vehicle-Trip Generation

Analysis Period	Weekday		
	In	Out	Total
Morning Peak Hour	25	84	109
Evening Peak Hour	81	48	129
Daily/24-hour	887	887	1,774

Based on the ITE estimate for the proposed residential development, the site is projected to generate about 1,774 external vehicle trips on the average weekday. During the weekday morning peak hour, approximately 25 vehicles would enter and 84 vehicles would exit the site. Approximately 81 entering vehicles and 48 exiting vehicles are projected for the weekday evening peak hour.

TRIP DISTRIBUTION AND ASSIGNMENT

Trip Directional Distribution

Estimating the directional distribution of site-generated vehicle trips to the study-area roads and intersections is a necessary component in determining the site's traffic impacts. Figure 5 shows the percentages of the site-generated vehicle trips projected to be oriented to and from the site's major approaches. Estimates have been based on the following factors: the proposed new land use, the area street and road system serving the site, previously-conducted traffic studies for the site, and the site's geographic location relative to the City of Colorado Springs. The short-term distribution assumes the new initial section of Powers Boulevard between I-25 and Voyager and the new Powers/Interstate-25 interchange ramps. The long-term distribution assumes Powers constructed between I-25 and State Highway 83.

Site-Generated Traffic

Figure 6 shows short-term projected site-generated traffic volumes for the weekday morning and evening peak hours. Figure 7 shows long-term projected site-generated traffic volumes for the weekday morning and evening peak hours. Site-generated traffic volumes at the following intersections have been calculated by applying the directional distribution percentages estimated by LSC (from Figure 5) to the trip-generation estimates (from Table 5):

- North Gate Boulevard/Bass Pro Drive
- Bass Pro Drive/existing access points north of Tracker Drive
- Bass Pro Drive/Tracker Drive
- Bass Pro Drive/proposed access point south of Tracker Drive

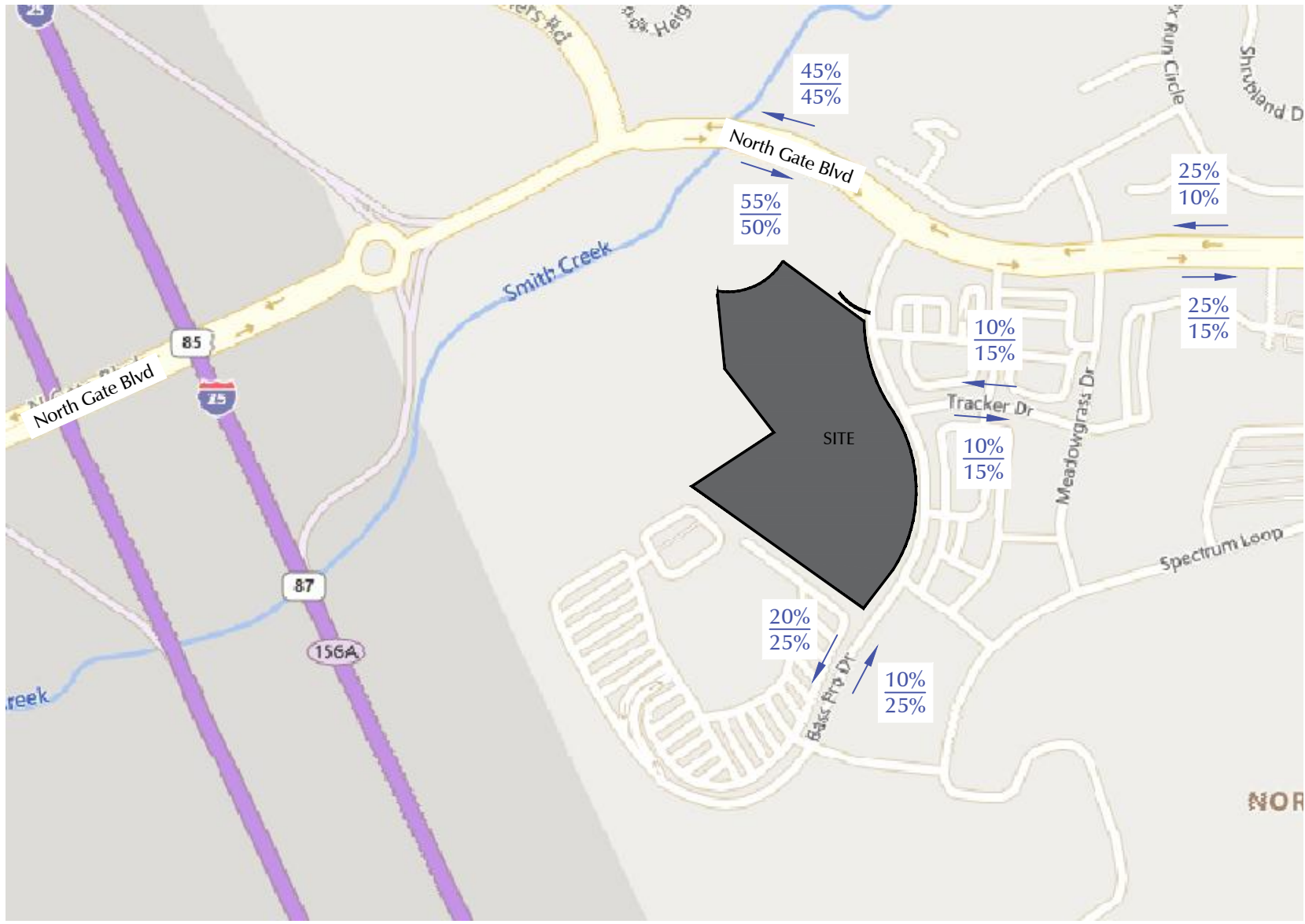

Figure 5

Directional Distribution

S214140 - Springs at Northgate



$\frac{XX\%}{XX\%}$ = $\frac{\text{Short-Term \% Distribution}}{\text{Long-Term \% Distribution}}$

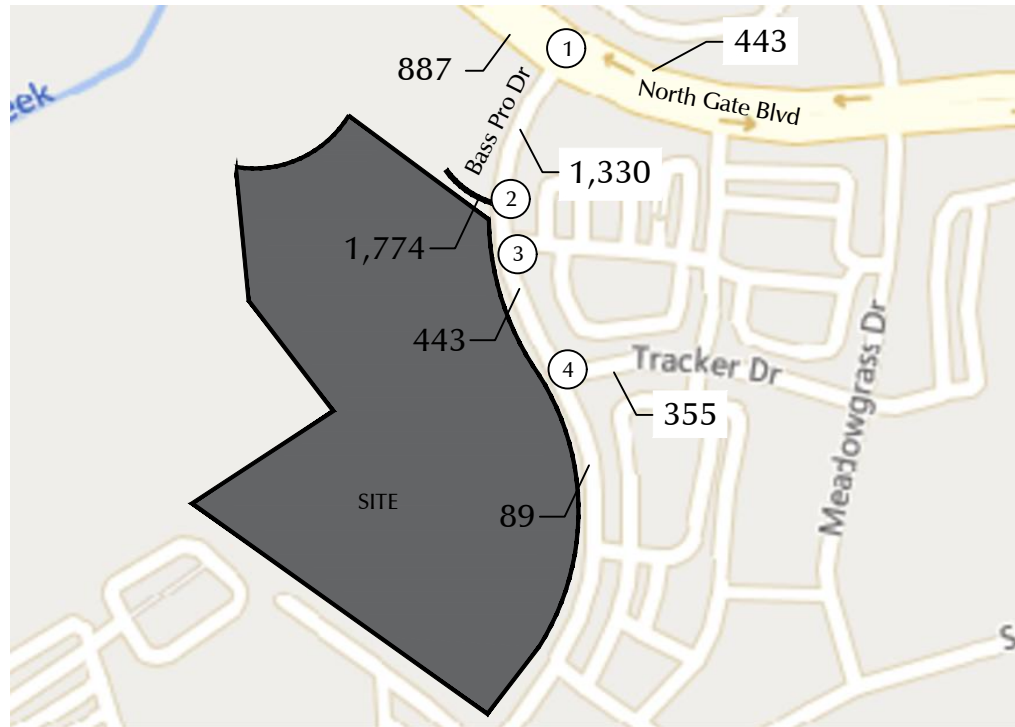
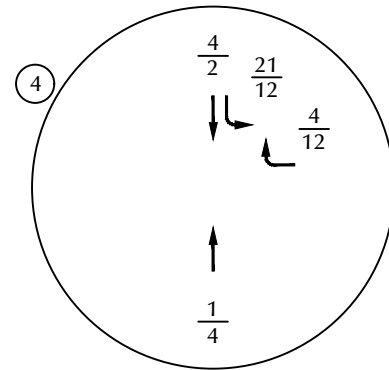
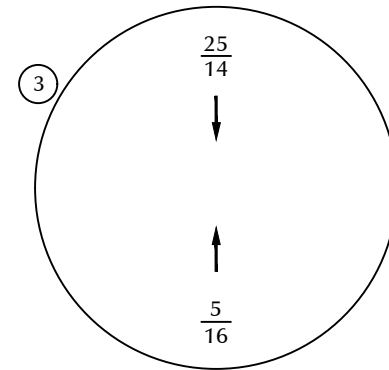
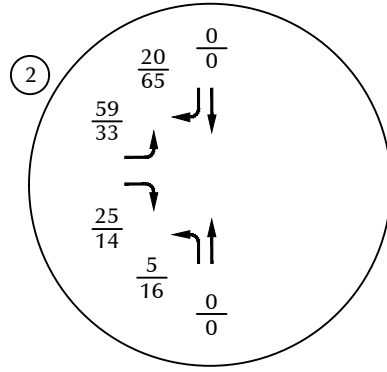
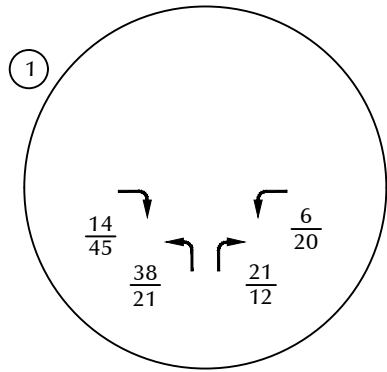

Site-Generated Traffic (Short-Term)

Figure 6



$\frac{XX}{XX}$ = AM Weekday Peak-Hour Traffic (Veh/Hour)
 $\frac{XX}{XX}$ = PM Weekday Peak-Hour Traffic (Veh/Hour)
 XXX = Average Daily Traffic (Vehicles/Day)

S214140 - Springs at Northgate

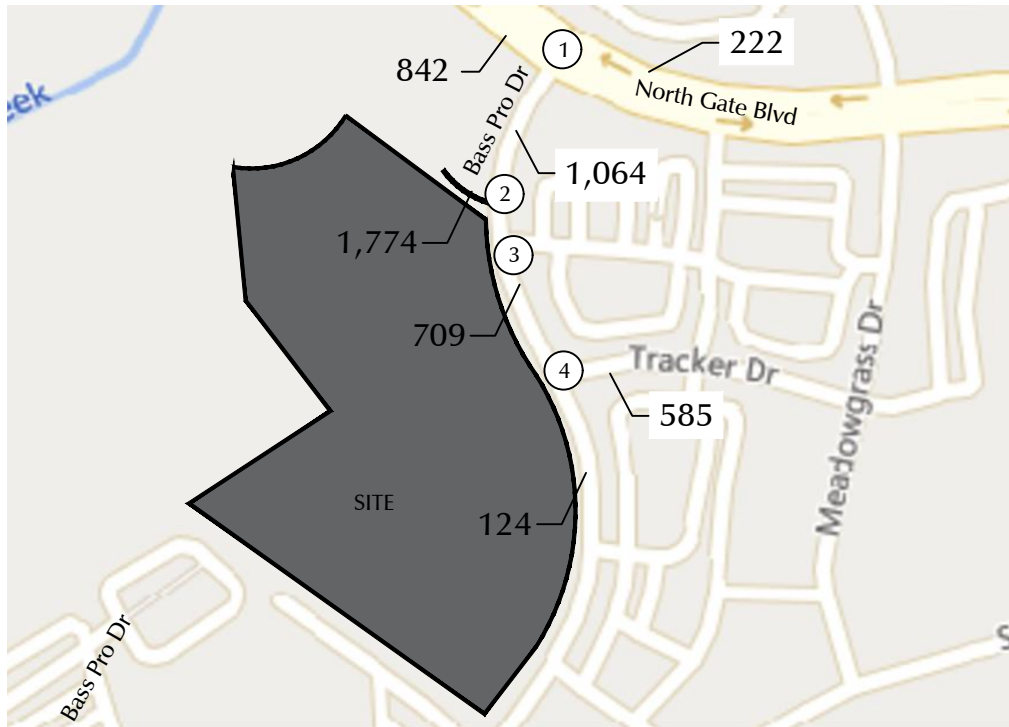
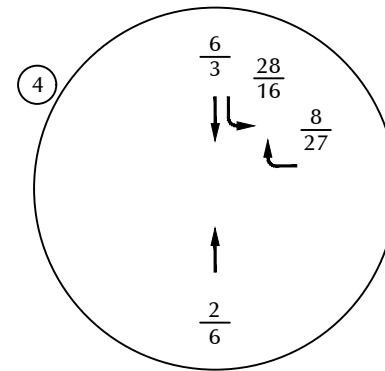
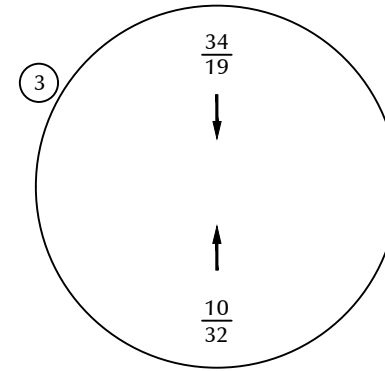
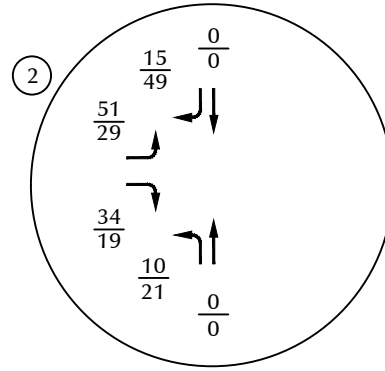
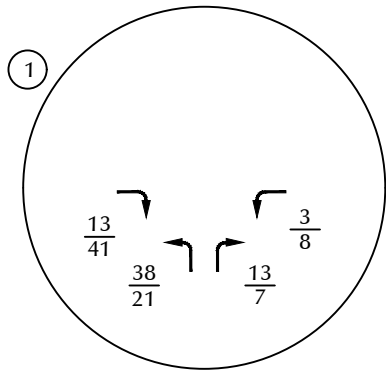

$\frac{XX}{XX}$ = AM Weekday Peak-Hour Traffic (Veh/Hour)
 $\frac{XX}{XX}$ = PM Weekday Peak-Hour Traffic (Veh/Hour)
 XXX = Average Daily Traffic (Vehicles/Day)

Site-Generated Traffic (Long-Term)

Figure 7

S214140 - Springs at Northgate

APPENDIX C

Trip Generation Worksheets

Project Spectrum and Voyager
 Subject Trip Generation for Multifamily Housing (Mid-Rise)
 Designed by TES Date August 29, 2022 Job No. 196103001
 Checked by _____ Date _____ Sheet No. _____ of _____

TRIP GENERATION MANUAL TECHNIQUES

ITE Trip Generation Manual 11th Edition, Average Rate Equations

Land Use Code - Multifamily Housing (Mid-Rise) (221)

Independent Variable - Dwelling Units (X)

$$X = 355$$

T = Average Vehicle Trip Ends

Peak Hour of Adjacent Street Traffic, One Hour Between 7 and 9 a.m. (200 Series Page 275)

Average Weekday	Directional Distribution:	23% ent.	77% exit.
(T) = 0.37 (X)	T = 131	Average Vehicle Trip Ends	
(T) = 0.37 * (355.0)	30 entering	101	exiting
	30 + 101 = 131		

Peak Hour of Adjacent Street Traffic, One Hour Between 4 and 6 p.m. (Site-Specific)

Average Weekday	Directional Distribution:	58% ent.	42% exit.
(T) = 0.49(X)	T = 174	Average Vehicle Trip Ends	
(T) = 0.49 * (355.0)	101 entering	73	exiting
	101 + 73 = 174		

Weekday (200 Series Page 274)

Average Weekday	Directional Distribution:	50% entering, 50% exiting	
(T) = 4.54 (X)	T = 1612	Average Vehicle Trip Ends	
(T) = 4.54 * (355.0)	806 entering	806	exiting
	806 + 806 = 1612		

Location: Falcon View Apts Entrance S/O Republic Dr
Date: 08/25/2022
Site Code: ADT1

Thursday, August 25, 2022					
Time	Light Vehicles		Heavy Vehicles		Total
	Volume		Volume		
	SB	NB	SB	NB	
6:00	2	8	0	0	47
6:15	1	10	0	0	
6:30	1	6	0	0	
6:45	5	14	0	0	
7:00	8	18	0	0	102
7:15	4	20	0	0	
7:30	6	22	0	0	
7:45	5	19	0	0	
8:00	5	15	0	0	79
8:15	5	14	1	0	
8:30	2	17	0	1	
8:45	4	15	0	0	
9:00	6	8	0	0	60
9:15	4	14	0	0	
9:30	5	6	0	0	
9:45	4	12	1	0	
10:00	6	5	0	0	45
10:15	7	9	0	0	
10:30	5	3	2	0	
10:45	1	6	0	1	
11:00	5	7	0	0	56
11:15	6	6	0	1	
11:30	6	10	0	0	
11:45	7	8	0	0	
12:00	5	7	0	0	59
12:15	10	8	1	0	
12:30	12	6	0	0	
12:45	5	5	0	0	
13:00	13	8	0	0	71
13:15	4	6	0	1	
13:30	9	3	0	0	
13:45	14	13	0	0	
14:00	6	7	1	0	59
14:15	7	1	0	1	
14:30	5	12	0	0	
14:45	11	8	0	0	
15:00	4	3	0	0	62
15:15	14	6	0	0	
15:30	7	6	0	0	
15:45	12	10	0	0	
16:00	9	9	0	0	99
16:15	18	10	0	0	
16:30	21	9	0	0	
16:45	12	11	0	0	
17:00	15	10	0	0	131
17:15	16	15	1	1	
17:30	25	18	0	0	
17:45	20	10	0	0	
18:00	21	15	0	0	118
18:15	17	13	0	1	
18:30	11	8	0	0	
18:45	24	8	0	0	
19:00	16	6	0	0	91
19:15	11	8	0	0	
19:30	21	5	0	0	
19:45	14	10	0	0	
14-HOUR TOTAL	519	546	7	7	1079

Thursday, August 25, 2022			
Time	Bikes on Road		Total
	Volume		
	SB	NB	
6:00	0	0	0
6:15	0	0	
6:30	0	0	
6:45	0	0	
7:00	0	0	0
7:15	0	0	
7:30	0	0	
7:45	0	0	
8:00	0	0	0
8:15	0	0	
8:30	0	0	
8:45	0	0	
9:00	0	0	0
9:15	0	0	
9:30	0	0	
9:45	0	0	
10:00	0	0	0
10:15	0	0	
10:30	0	0	
10:45	0	0	
11:00	0	0	0
11:15	0	0	
11:30	0	0	
11:45	0	0	
12:00	0	0	0
12:15	0	0	
12:30	0	0	
12:45	0	0	
13:00	0	0	0
13:15	0	0	
13:30	0	0	
13:45	0	0	
14:00	0	0	0
14:15	0	0	
14:30	0	0	
14:45	0	0	
15:00	0	1	1
15:15	0	0	
15:30	0	0	
15:45	0	0	
16:00	0	0	1
16:15	0	0	
16:30	0	1	
16:45	0	0	
17:00	0	0	0
17:15	0	0	
17:30	0	0	
17:45	0	0	
18:00	0	0	1
18:15	1	0	
18:30	0	0	
18:45	0	0	
19:00	0	0	0
19:15	0	0	
19:30	0	0	
19:45	0	0	
14-HOUR TOTAL	1	2	3

Peak Hour
 47
 63
 76
 97
102
 96
 92
 84
 79
 73
 71
 62
 60
 57
 55
 54
 45
 46
 43
 49
 56
 56
 62
 64
 59
 68
 60
 54
 71
 64
 62
 67
 59
 52
 63
 59
 62
 73
 81
 98
 99
 106
 111
 124
 131
142
 140
 116
 118
 104
 92
 99
 91

Project Spectrum and Voyager - Current Zoning
 Subject Trip Generation for General Office Building
 Designed by TES Date February 24, 2022 Job No. 196103001
 Checked by _____ Date _____ Sheet No. 1 of 1

TRIP GENERATION MANUAL TECHNIQUES

ITE Trip Generation Manual 11th Edition, Average Rates

Land Use Code - General Office Building (710)

Independant Variable - 1000 Square Feet (X)

SF = 200,000

X = 200.000

T = Average Vehicle Trip Ends

Peak Hour of Adjacent Street Traffic, One Hour Between 7 and 9 a.m. (700 Series Page 710)

(T) = 1.52 (X)		Directional Distribution:	88% ent.	12% exit.
(T) = 1.52 *	(200.0)	T = 304	Average Vehicle Trip Ends	
		268 entering	36	exiting
		268 + 36 =	304	

Peak Hour of Adjacent Street Traffic, One Hour Between 4 and 6 p.m. (700 Series Page 711)

(T) = 1.44 (X)		Directional Distribution:	17% ent.	83% exit.
(T) = 1.44 *	(200.0)	T = 288	Average Vehicle Trip Ends	
		49 entering	239	exiting
		49 + 239 =	288	

Weekday (700 Series Page 709)

(T) = 10.84 (X)		Directional Distribution:	50% ent.	50% exit.
(T) = 10.84 *	(200.0)	T = 2168	Average Vehicle Trip Ends	
		1084 entering	1084	exiting
		1084 + 1084 =	2168	

APPENDIX D

Intersection Analysis Worksheets

Timings
1: Voyager Pkwy & North Gate Blvd

2022 Existing AM
08/25/2022

Lane Group	EBL	EBT	EBR	WBL	WBT	WBR	NBL	NBT	NBR	SBL	SBT	SBR
Lane Configurations												
Traffic Volume (vph)	8	305	168	324	423	14	150	25	181	54	80	41
Future Volume (vph)	8	305	168	324	423	14	150	25	181	54	80	41
Turn Type	pm+pt	NA	Perm	pm+pt	NA	Perm	Prot	NA	Perm	pm+pt	NA	Perm
Protected Phases	5	2		1	6		7	4		3	8	
Permitted Phases	2		2	6		6			4	8		8
Detector Phase	5	2	2	1	6	6	7	4	4	3	8	8
Switch Phase												
Minimum Initial (s)	4.0	10.0	10.0	4.0	10.0	10.0	4.0	4.0	4.0	4.0	4.0	4.0
Minimum Split (s)	9.0	25.0	25.0	9.0	25.0	25.0	9.0	25.0	25.0	9.0	25.0	25.0
Total Split (s)	15.0	44.0	44.0	25.0	54.0	54.0	25.0	34.0	34.0	17.0	26.0	26.0
Total Split (%)	12.5%	36.7%	36.7%	20.8%	45.0%	45.0%	20.8%	28.3%	28.3%	14.2%	21.7%	21.7%
Yellow Time (s)	3.0	5.0	5.0	3.0	5.0	5.0	3.0	5.0	5.0	3.0	5.0	5.0
All-Red Time (s)	2.0	2.0	2.0	2.0	2.0	2.0	2.0	2.0	2.0	2.0	2.0	2.0
Lost Time Adjust (s)	0.0	0.0	0.0	0.0	0.0	0.0	0.0	0.0	0.0	0.0	0.0	0.0
Total Lost Time (s)	5.0	7.0	7.0	5.0	7.0	7.0	5.0	7.0	7.0	5.0	7.0	7.0
Lead/Lag	Lead	Lag	Lag	Lead	Lag	Lag	Lead	Lag	Lag	Lead	Lag	Lag
Lead-Lag Optimize?	Yes	Yes	Yes	Yes	Yes	Yes	Yes	Yes	Yes	Yes	Yes	Yes
Recall Mode	None	C-Max	C-Max	None	C-Max	C-Max	None	None	None	None	None	None
Act Effct Green (s)	69.5	61.7	61.7	83.9	79.7	79.7	11.0	12.7	12.7	19.7	10.9	10.9
Actuated g/C Ratio	0.58	0.51	0.51	0.70	0.66	0.66	0.09	0.11	0.11	0.16	0.09	0.09
v/c Ratio	0.02	0.18	0.20	0.45	0.19	0.01	0.51	0.14	0.57	0.23	0.51	0.13
Control Delay	9.6	18.9	2.1	10.3	10.0	0.0	57.5	47.9	13.4	36.5	61.9	0.8
Queue Delay	0.0	0.0	0.0	0.0	0.0	0.0	0.0	0.0	0.0	0.0	0.0	0.0
Total Delay	9.6	18.9	2.1	10.3	10.0	0.0	57.5	47.9	13.4	36.5	61.9	0.8
LOS	A	B	A	B	A	A	E	D	B	D	E	A
Approach Delay		12.8			9.9			34.4			39.7	
Approach LOS		B			A			C			D	

Intersection Summary

Cycle Length: 120
 Actuated Cycle Length: 120
 Offset: 22 (18%), Referenced to phase 2:EBTL and 6:WBTL, Start of Green
 Natural Cycle: 70
 Control Type: Actuated-Coordinated
 Maximum v/c Ratio: 0.57
 Intersection Signal Delay: 18.6
 Intersection Capacity Utilization 53.2%
 Analysis Period (min) 15
 Intersection LOS: B
 ICU Level of Service A

Splits and Phases: 1: Voyager Pkwy & North Gate Blvd



HCM 6th Signalized Intersection Summary
 1: Voyager Pkwy & North Gate Blvd

2022 Existing AM
 08/25/2022



Movement	EBL	EBT	EBR	WBL	WBT	WBR	NBL	NBT	NBR	SBL	SBT	SBR
Lane Configurations	↘	↑↑	↗	↘	↑↑	↗	↘↗	↑	↗	↘	↑	↗
Traffic Volume (veh/h)	8	305	168	324	423	14	150	25	181	54	80	41
Future Volume (veh/h)	8	305	168	324	423	14	150	25	181	54	80	41
Initial Q (Qb), veh	0	0	0	0	0	0	0	0	0	0	0	0
Ped-Bike Adj(A_pbT)	1.00		1.00	1.00		1.00	1.00		1.00	1.00		1.00
Parking Bus, Adj	1.00	1.00	1.00	1.00	1.00	1.00	1.00	1.00	1.00	1.00	1.00	1.00
Work Zone On Approach		No			No			No			No	
Adj Sat Flow, veh/h/ln	1870	1870	1870	1870	1870	1870	1870	1870	1870	1870	1870	1870
Adj Flow Rate, veh/h	9	328	181	348	455	15	161	27	195	58	86	44
Peak Hour Factor	0.93	0.93	0.93	0.93	0.93	0.93	0.93	0.93	0.93	0.93	0.93	0.93
Percent Heavy Veh, %	2	2	2	2	2	2	2	2	2	2	2	2
Cap, veh/h	545	1809	807	666	2171	968	225	265	224	263	216	183
Arrive On Green	0.01	0.51	0.51	0.11	0.61	0.61	0.07	0.14	0.14	0.04	0.12	0.12
Sat Flow, veh/h	1781	3554	1585	1781	3554	1585	3456	1870	1585	1781	1870	1585
Grp Volume(v), veh/h	9	328	181	348	455	15	161	27	195	58	86	44
Grp Sat Flow(s),veh/h/ln	1781	1777	1585	1781	1777	1585	1728	1870	1585	1781	1870	1585
Q Serve(g_s), s	0.3	6.0	7.6	10.6	6.9	0.4	5.5	1.5	14.5	3.4	5.1	3.0
Cycle Q Clear(g_c), s	0.3	6.0	7.6	10.6	6.9	0.4	5.5	1.5	14.5	3.4	5.1	3.0
Prop In Lane	1.00		1.00	1.00		1.00	1.00		1.00	1.00		1.00
Lane Grp Cap(c), veh/h	545	1809	807	666	2171	968	225	265	224	263	216	183
V/C Ratio(X)	0.02	0.18	0.22	0.52	0.21	0.02	0.71	0.10	0.87	0.22	0.40	0.24
Avail Cap(c_a), veh/h	678	1809	807	766	2171	968	576	421	357	372	296	251
HCM Platoon Ratio	1.00	1.00	1.00	1.00	1.00	1.00	1.00	1.00	1.00	1.00	1.00	1.00
Upstream Filter(l)	1.00	1.00	1.00	1.00	1.00	1.00	1.00	1.00	1.00	1.00	1.00	1.00
Uniform Delay (d), s/veh	14.0	15.9	16.3	10.3	10.4	9.2	55.0	44.9	50.4	44.4	49.2	48.3
Incr Delay (d2), s/veh	0.0	0.2	0.6	0.6	0.2	0.0	4.2	0.2	12.7	0.4	1.2	0.7
Initial Q Delay(d3),s/veh	0.0	0.0	0.0	0.0	0.0	0.0	0.0	0.0	0.0	0.0	0.0	0.0
%ile BackOfQ(50%),veh/ln	0.1	2.5	2.9	4.1	2.7	0.2	2.5	0.7	6.5	1.5	2.5	1.2
Unsig. Movement Delay, s/veh												
LnGrp Delay(d),s/veh	14.0	16.2	17.0	10.9	10.6	9.2	59.2	45.0	63.1	44.8	50.4	49.0
LnGrp LOS	B	B	B	B	B	A	E	D	E	D	D	D
Approach Vol, veh/h		518			818			383			188	
Approach Delay, s/veh		16.4			10.7			60.2			48.3	
Approach LOS		B			B			E			D	
Timer - Assigned Phs	1	2	3	4	5	6	7	8				
Phs Duration (G+Y+Rc), s	18.3	68.1	9.7	24.0	6.0	80.3	12.8	20.8				
Change Period (Y+Rc), s	5.0	7.0	5.0	7.0	5.0	7.0	5.0	7.0				
Max Green Setting (Gmax), s	20.0	37.0	12.0	27.0	10.0	47.0	20.0	19.0				
Max Q Clear Time (g_c+l1), s	12.6	9.6	5.4	16.5	2.3	8.9	7.5	7.1				
Green Ext Time (p_c), s	0.7	2.9	0.0	0.5	0.0	3.4	0.4	0.4				
Intersection Summary												
HCM 6th Ctrl Delay			25.9									
HCM 6th LOS			C									

Timings
1: Voyager Pkwy & North Gate Blvd

2022 Existing PM
08/29/2022

Lane Group	EBL	EBT	EBR	WBL	WBT	WBR	NBL	NBT	NBR	SBL	SBT	SBR
Lane Configurations												
Traffic Volume (vph)	28	422	181	287	378	29	239	53	229	31	38	23
Future Volume (vph)	28	422	181	287	378	29	239	53	229	31	38	23
Turn Type	pm+pt	NA	Perm	pm+pt	NA	Perm	Prot	NA	Perm	pm+pt	NA	Perm
Protected Phases	5	2		1	6		7	4		3	8	
Permitted Phases	2		2	6		6			4	8		8
Detector Phase	5	2	2	1	6	6	7	4	4	3	8	8
Switch Phase												
Minimum Initial (s)	4.0	10.0	10.0	4.0	10.0	10.0	4.0	4.0	4.0	4.0	4.0	4.0
Minimum Split (s)	9.0	25.0	25.0	9.0	25.0	25.0	9.0	25.0	25.0	9.0	25.0	25.0
Total Split (s)	15.0	44.0	44.0	25.0	54.0	54.0	25.0	34.0	34.0	17.0	26.0	26.0
Total Split (%)	12.5%	36.7%	36.7%	20.8%	45.0%	45.0%	20.8%	28.3%	28.3%	14.2%	21.7%	21.7%
Yellow Time (s)	3.0	5.0	5.0	3.0	5.0	5.0	3.0	5.0	5.0	3.0	5.0	5.0
All-Red Time (s)	2.0	2.0	2.0	2.0	2.0	2.0	2.0	2.0	2.0	2.0	2.0	2.0
Lost Time Adjust (s)	0.0	0.0	0.0	0.0	0.0	0.0	0.0	0.0	0.0	0.0	0.0	0.0
Total Lost Time (s)	5.0	7.0	7.0	5.0	7.0	7.0	5.0	7.0	7.0	5.0	7.0	7.0
Lead/Lag	Lead	Lag	Lag	Lead	Lag	Lag	Lead	Lag	Lag	Lead	Lag	Lag
Lead-Lag Optimize?	Yes	Yes	Yes	Yes	Yes	Yes	Yes	Yes	Yes	Yes	Yes	Yes
Recall Mode	None	C-Max	C-Max	None	C-Max	C-Max	None	None	None	None	None	None
Act Effct Green (s)	70.2	62.0	62.0	83.0	74.0	74.0	14.4	17.1	17.1	15.9	8.1	8.1
Actuated g/C Ratio	0.58	0.52	0.52	0.69	0.62	0.62	0.12	0.14	0.14	0.13	0.07	0.07
v/c Ratio	0.05	0.25	0.21	0.46	0.19	0.03	0.63	0.22	0.57	0.17	0.33	0.08
Control Delay	9.2	19.0	2.8	10.7	12.5	0.1	57.2	46.8	11.0	35.3	59.5	0.5
Queue Delay	0.0	0.0	0.0	0.0	0.0	0.0	0.0	0.0	0.0	0.0	0.0	0.0
Total Delay	9.2	19.0	2.8	10.7	12.5	0.1	57.2	46.8	11.0	35.3	59.5	0.5
LOS	A	B	A	B	B	A	E	D	B	D	E	A
Approach Delay		13.9			11.2			35.8			36.5	
Approach LOS		B			B			D			D	

Intersection Summary

Cycle Length: 120
 Actuated Cycle Length: 120
 Offset: 22 (18%), Referenced to phase 2:EBTL and 6:WBTL, Start of Green
 Natural Cycle: 70
 Control Type: Actuated-Coordinated
 Maximum v/c Ratio: 0.63
 Intersection Signal Delay: 19.9
 Intersection Capacity Utilization 56.9%
 Analysis Period (min) 15

Intersection LOS: B
 ICU Level of Service B

Splits and Phases: 1: Voyager Pkwy & North Gate Blvd

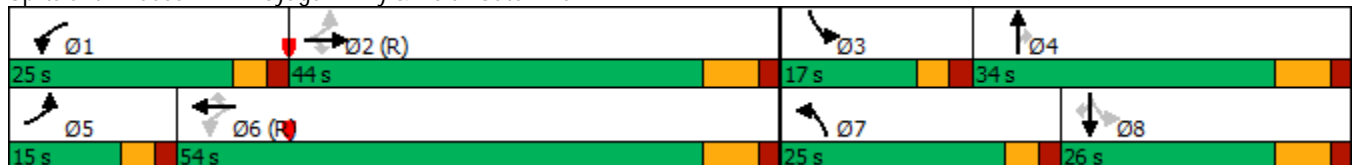

HCM 6th Signalized Intersection Summary
1: Voyager Pkwy & North Gate Blvd

2022 Existing PM
08/29/2022



Movement	EBL	EBT	EBR	WBL	WBT	WBR	NBL	NBT	NBR	SBL	SBT	SBR
Lane Configurations												
Traffic Volume (veh/h)	28	422	181	287	378	29	239	53	229	31	38	23
Future Volume (veh/h)	28	422	181	287	378	29	239	53	229	31	38	23
Initial Q (Qb), veh	0	0	0	0	0	0	0	0	0	0	0	0
Ped-Bike Adj(A_pbT)	1.00		1.00	1.00		1.00	1.00		1.00	1.00		1.00
Parking Bus, Adj	1.00	1.00	1.00	1.00	1.00	1.00	1.00	1.00	1.00	1.00	1.00	1.00
Work Zone On Approach		No			No			No			No	
Adj Sat Flow, veh/h/ln	1870	1870	1870	1870	1870	1870	1870	1870	1870	1870	1870	1870
Adj Flow Rate, veh/h	30	459	197	312	411	32	260	58	249	34	41	25
Peak Hour Factor	0.92	0.92	0.92	0.92	0.92	0.92	0.92	0.92	0.92	0.92	0.92	0.92
Percent Heavy Veh, %	2	2	2	2	2	2	2	2	2	2	2	2
Cap, veh/h	569	1772	790	573	2062	920	329	328	278	212	193	164
Arrive On Green	0.02	0.50	0.50	0.10	0.58	0.58	0.10	0.18	0.18	0.02	0.10	0.10
Sat Flow, veh/h	1781	3554	1585	1781	3554	1585	3456	1870	1585	1781	1870	1585
Grp Volume(v), veh/h	30	459	197	312	411	32	260	58	249	34	41	25
Grp Sat Flow(s),veh/h/ln	1781	1777	1585	1781	1777	1585	1728	1870	1585	1781	1870	1585
Q Serve(g_s), s	1.0	8.9	8.5	9.7	6.6	1.0	8.8	3.2	18.4	2.0	2.4	1.7
Cycle Q Clear(g_c), s	1.0	8.9	8.5	9.7	6.6	1.0	8.8	3.2	18.4	2.0	2.4	1.7
Prop In Lane	1.00		1.00	1.00		1.00	1.00		1.00	1.00		1.00
Lane Grp Cap(c), veh/h	569	1772	790	573	2063	920	329	328	278	212	193	164
V/C Ratio(X)	0.05	0.26	0.25	0.54	0.20	0.03	0.79	0.18	0.89	0.16	0.21	0.15
Avail Cap(c_a), veh/h	680	1772	790	687	2063	920	576	421	357	349	296	251
HCM Platoon Ratio	1.00	1.00	1.00	1.00	1.00	1.00	1.00	1.00	1.00	1.00	1.00	1.00
Upstream Filter(I)	1.00	1.00	1.00	1.00	1.00	1.00	0.99	0.99	0.99	1.00	1.00	1.00
Uniform Delay (d), s/veh	14.1	17.3	17.2	11.4	11.9	10.8	53.1	42.1	48.4	46.7	49.3	49.0
Incr Delay (d2), s/veh	0.0	0.4	0.8	0.8	0.2	0.1	4.2	0.3	20.1	0.4	0.5	0.4
Initial Q Delay(d3),s/veh	0.0	0.0	0.0	0.0	0.0	0.0	0.0	0.0	0.0	0.0	0.0	0.0
%ile BackOfQ(50%),veh/ln	0.4	3.7	3.3	3.8	2.6	0.4	4.0	1.5	8.8	0.9	1.2	0.7
Unsig. Movement Delay, s/veh												
LnGrp Delay(d),s/veh	14.1	17.7	18.0	12.2	12.2	10.9	57.3	42.3	68.5	47.0	49.9	49.4
LnGrp LOS	B	B	B	B	B	B	E	D	E	D	D	D
Approach Vol, veh/h		686			755			567			100	
Approach Delay, s/veh		17.6			12.1			60.7			48.8	
Approach LOS		B			B			E			D	
Timer - Assigned Phs	1	2	3	4	5	6	7	8				
Phs Duration (G+Y+Rc), s	17.3	66.8	7.8	28.1	7.5	76.6	16.4	19.4				
Change Period (Y+Rc), s	5.0	7.0	5.0	7.0	5.0	7.0	5.0	7.0				
Max Green Setting (Gmax), s	20.0	37.0	12.0	27.0	10.0	47.0	20.0	19.0				
Max Q Clear Time (g_c+I1), s	11.7	10.9	4.0	20.4	3.0	8.6	10.8	4.4				
Green Ext Time (p_c), s	0.6	3.9	0.0	0.6	0.0	3.1	0.6	0.2				
Intersection Summary												
HCM 6th Ctrl Delay			28.7									
HCM 6th LOS			C									

Timings
1: Voyager Pkwy & North Gate Blvd

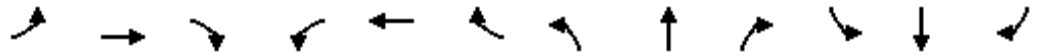

Lane Group	EBL	EBT	EBR	WBL	WBT	WBR	NBL	NBT	NBR	SBL	SBT	SBR
Lane Configurations	↘	↗↗	↗	↘	↗↗	↗	↗↗	↗	↗	↘	↗	↗
Traffic Volume (vph)	8	344	191	358	454	14	182	25	215	54	80	41
Future Volume (vph)	8	344	191	358	454	14	182	25	215	54	80	41
Turn Type	pm+pt	NA	Perm	pm+pt	NA	Perm	Prot	NA	Perm	pm+pt	NA	Perm
Protected Phases	5	2		1	6		7	4		3	8	
Permitted Phases	2		2	6		6			4	8		8
Detector Phase	5	2	2	1	6	6	7	4	4	3	8	8
Switch Phase												
Minimum Initial (s)	4.0	10.0	10.0	4.0	10.0	10.0	4.0	4.0	4.0	4.0	4.0	4.0
Minimum Split (s)	9.0	25.0	25.0	9.0	25.0	25.0	9.0	25.0	25.0	9.0	25.0	25.0
Total Split (s)	15.0	44.0	44.0	25.0	54.0	54.0	25.0	34.0	34.0	17.0	26.0	26.0
Total Split (%)	12.5%	36.7%	36.7%	20.8%	45.0%	45.0%	20.8%	28.3%	28.3%	14.2%	21.7%	21.7%
Yellow Time (s)	3.0	5.0	5.0	3.0	5.0	5.0	3.0	5.0	5.0	3.0	5.0	5.0
All-Red Time (s)	2.0	2.0	2.0	2.0	2.0	2.0	2.0	2.0	2.0	2.0	2.0	2.0
Lost Time Adjust (s)	0.0	0.0	0.0	0.0	0.0	0.0	0.0	0.0	0.0	0.0	0.0	0.0
Total Lost Time (s)	5.0	7.0	7.0	5.0	7.0	7.0	5.0	7.0	7.0	5.0	7.0	7.0
Lead/Lag	Lead	Lag	Lag	Lead	Lag	Lag	Lead	Lag	Lag	Lead	Lag	Lag
Lead-Lag Optimize?	Yes	Yes	Yes	Yes	Yes	Yes	Yes	Yes	Yes	Yes	Yes	Yes
Recall Mode	None	C-Max	C-Max	None	C-Max	C-Max	None	None	None	None	None	None
Act Effct Green (s)	66.6	58.9	58.9	82.7	78.4	78.4	12.2	14.0	14.0	19.6	10.9	10.9
Actuated g/C Ratio	0.56	0.49	0.49	0.69	0.65	0.65	0.10	0.12	0.12	0.16	0.09	0.09
v/c Ratio	0.02	0.21	0.23	0.52	0.21	0.01	0.56	0.12	0.60	0.23	0.51	0.13
Control Delay	10.6	21.1	3.6	11.7	10.7	0.0	57.5	46.4	12.6	35.6	61.9	0.8
Queue Delay	0.0	0.0	0.0	0.0	0.0	0.0	0.0	0.0	0.0	0.0	0.0	0.0
Total Delay	10.6	21.1	3.6	11.7	10.7	0.0	57.5	46.4	12.6	35.6	61.9	0.8
LOS	B	C	A	B	B	A	E	D	B	D	E	A
Approach Delay		14.8			10.9			34.0			39.5	
Approach LOS		B			B			C			D	

Intersection Summary

Cycle Length: 120
 Actuated Cycle Length: 120
 Offset: 22 (18%), Referenced to phase 2:EBTL and 6:WBTL, Start of Green
 Natural Cycle: 70
 Control Type: Actuated-Coordinated
 Maximum v/c Ratio: 0.60
 Intersection Signal Delay: 19.5
 Intersection Capacity Utilization 57.0%
 Analysis Period (min) 15
 Intersection LOS: B
 ICU Level of Service B

Splits and Phases: 1: Voyager Pkwy & North Gate Blvd

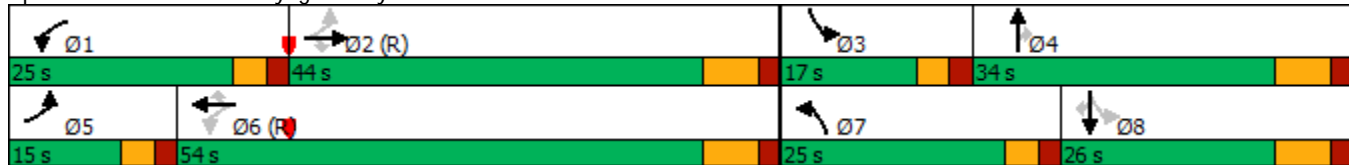

HCM 6th Signalized Intersection Summary
 1: Voyager Pkwy & North Gate Blvd

2024 Background AM

08/29/2022

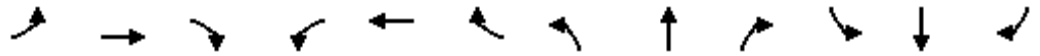

Movement	EBL	EBT	EBR	WBL	WBT	WBR	NBL	NBT	NBR	SBL	SBT	SBR
Lane Configurations	↘	↗↗	↘	↘	↗↗	↘	↘↘	↗	↘	↘	↗	↘
Traffic Volume (veh/h)	8	344	191	358	454	14	182	25	215	54	80	41
Future Volume (veh/h)	8	344	191	358	454	14	182	25	215	54	80	41
Initial Q (Qb), veh	0	0	0	0	0	0	0	0	0	0	0	0
Ped-Bike Adj(A_pbT)	1.00		1.00	1.00		1.00	1.00		1.00	1.00		1.00
Parking Bus, Adj	1.00	1.00	1.00	1.00	1.00	1.00	1.00	1.00	1.00	1.00	1.00	1.00
Work Zone On Approach		No			No			No			No	
Adj Sat Flow, veh/h/ln	1870	1870	1870	1870	1870	1870	1870	1870	1870	1870	1870	1870
Adj Flow Rate, veh/h	9	370	205	385	488	15	196	27	231	58	86	44
Peak Hour Factor	0.93	0.93	0.93	0.93	0.93	0.93	0.93	0.93	0.93	0.93	0.93	0.93
Percent Heavy Veh, %	2	2	2	2	2	2	2	2	2	2	2	2
Cap, veh/h	496	1668	744	630	2093	933	263	307	260	271	237	201
Arrive On Green	0.01	0.47	0.47	0.13	0.59	0.59	0.08	0.16	0.16	0.04	0.13	0.13
Sat Flow, veh/h	1781	3554	1585	1781	3554	1585	3456	1870	1585	1781	1870	1585
Grp Volume(v), veh/h	9	370	205	385	488	15	196	27	231	58	86	44
Grp Sat Flow(s),veh/h/ln	1781	1777	1585	1781	1777	1585	1728	1870	1585	1781	1870	1585
Q Serve(g_s), s	0.3	7.4	9.5	12.8	7.9	0.5	6.7	1.5	17.1	3.4	5.1	3.0
Cycle Q Clear(g_c), s	0.3	7.4	9.5	12.8	7.9	0.5	6.7	1.5	17.1	3.4	5.1	3.0
Prop In Lane	1.00		1.00	1.00		1.00	1.00		1.00	1.00		1.00
Lane Grp Cap(c), veh/h	496	1668	744	630	2093	933	263	307	260	271	237	201
V/C Ratio(X)	0.02	0.22	0.28	0.61	0.23	0.02	0.75	0.09	0.89	0.21	0.36	0.22
Avail Cap(c_a), veh/h	629	1668	744	699	2093	933	576	421	357	380	296	251
HCM Platoon Ratio	1.00	1.00	1.00	1.00	1.00	1.00	1.00	1.00	1.00	1.00	1.00	1.00
Upstream Filter(l)	1.00	1.00	1.00	1.00	1.00	1.00	0.99	0.99	0.99	1.00	1.00	1.00
Uniform Delay (d), s/veh	16.4	18.9	19.4	12.1	11.8	10.2	54.3	42.6	49.1	43.2	48.0	47.1
Incr Delay (d2), s/veh	0.0	0.3	0.9	1.3	0.3	0.0	4.2	0.1	18.1	0.4	0.9	0.5
Initial Q Delay(d3),s/veh	0.0	0.0	0.0	0.0	0.0	0.0	0.0	0.0	0.0	0.0	0.0	0.0
%ile BackOfQ(50%),veh/ln	0.1	3.1	3.7	5.1	3.1	0.2	3.1	0.7	8.1	1.5	2.4	1.2
Unsig. Movement Delay, s/veh												
LnGrp Delay(d),s/veh	16.4	19.2	20.3	13.4	12.0	10.3	58.5	42.7	67.2	43.6	48.9	47.6
LnGrp LOS	B	B	C	B	B	B	E	D	E	D	D	D
Approach Vol, veh/h		584			888			454			188	
Approach Delay, s/veh		19.5			12.6			62.0			47.0	
Approach LOS		B			B			E			D	
Timer - Assigned Phs	1	2	3	4	5	6	7	8				
Phs Duration (G+Y+Rc), s	20.4	63.3	9.6	26.7	6.0	77.7	14.1	22.2				
Change Period (Y+Rc), s	5.0	7.0	5.0	7.0	5.0	7.0	5.0	7.0				
Max Green Setting (Gmax), s	20.0	37.0	12.0	27.0	10.0	47.0	20.0	19.0				
Max Q Clear Time (g_c+l1), s	14.8	11.5	5.4	19.1	2.3	9.9	8.7	7.1				
Green Ext Time (p_c), s	0.6	3.2	0.0	0.5	0.0	3.7	0.5	0.4				
Intersection Summary												
HCM 6th Ctrl Delay			28.2									
HCM 6th LOS			C									

Timings
1: Voyager Pkwy & North Gate Blvd

2024 Background PM

08/29/2022

Lane Group	EBL	EBT	EBR	WBL	WBT	WBR	NBL	NBT	NBR	SBL	SBT	SBR
Lane Configurations												
Traffic Volume (vph)	28	459	216	328	420	29	269	53	262	31	38	23
Future Volume (vph)	28	459	216	328	420	29	269	53	262	31	38	23
Turn Type	pm+pt	NA	Perm	pm+pt	NA	Perm	Prot	NA	Perm	pm+pt	NA	Perm
Protected Phases	5	2		1	6		7	4		3	8	
Permitted Phases	2		2	6		6			4	8		8
Detector Phase	5	2	2	1	6	6	7	4	4	3	8	8
Switch Phase												
Minimum Initial (s)	4.0	10.0	10.0	4.0	10.0	10.0	4.0	4.0	4.0	4.0	4.0	4.0
Minimum Split (s)	9.0	25.0	25.0	9.0	25.0	25.0	9.0	25.0	25.0	9.0	25.0	25.0
Total Split (s)	15.0	44.0	44.0	25.0	54.0	54.0	25.0	34.0	34.0	17.0	26.0	26.0
Total Split (%)	12.5%	36.7%	36.7%	20.8%	45.0%	45.0%	20.8%	28.3%	28.3%	14.2%	21.7%	21.7%
Yellow Time (s)	3.0	5.0	5.0	3.0	5.0	5.0	3.0	5.0	5.0	3.0	5.0	5.0
All-Red Time (s)	2.0	2.0	2.0	2.0	2.0	2.0	2.0	2.0	2.0	2.0	2.0	2.0
Lost Time Adjust (s)	0.0	0.0	0.0	0.0	0.0	0.0	0.0	0.0	0.0	0.0	0.0	0.0
Total Lost Time (s)	5.0	7.0	7.0	5.0	7.0	7.0	5.0	7.0	7.0	5.0	7.0	7.0
Lead/Lag	Lead	Lag	Lag	Lead	Lag	Lag	Lead	Lag	Lag	Lead	Lag	Lag
Lead-Lag Optimize?	Yes	Yes	Yes	Yes	Yes	Yes	Yes	Yes	Yes	Yes	Yes	Yes
Recall Mode	None	C-Max	C-Max	None	C-Max	C-Max	None	None	None	None	None	None
Act Effct Green (s)	67.3	59.1	59.1	82.0	73.0	73.0	15.4	18.2	18.2	15.8	8.1	8.1
Actuated g/C Ratio	0.56	0.49	0.49	0.68	0.61	0.61	0.13	0.15	0.15	0.13	0.07	0.07
v/c Ratio	0.05	0.29	0.26	0.55	0.21	0.03	0.66	0.21	0.59	0.17	0.33	0.08
Control Delay	10.0	21.4	4.0	12.4	13.2	0.1	57.1	45.4	10.6	34.5	59.5	0.5
Queue Delay	0.0	0.0	0.0	0.0	0.0	0.0	0.0	0.0	0.0	0.0	0.0	0.0
Total Delay	10.0	21.4	4.0	12.4	13.2	0.1	57.1	45.4	10.6	34.5	59.5	0.5
LOS	A	C	A	B	B	A	E	D	B	C	E	A
Approach Delay		15.6			12.4			35.1			36.3	
Approach LOS		B			B			D			D	

Intersection Summary

Cycle Length: 120
 Actuated Cycle Length: 120
 Offset: 22 (18%), Referenced to phase 2:EBTL and 6:WBTL, Start of Green
 Natural Cycle: 75
 Control Type: Actuated-Coordinated
 Maximum v/c Ratio: 0.66
 Intersection Signal Delay: 20.6
 Intersection Capacity Utilization 61.0%
 Analysis Period (min) 15
 Intersection LOS: C
 ICU Level of Service B

Splits and Phases: 1: Voyager Pkwy & North Gate Blvd

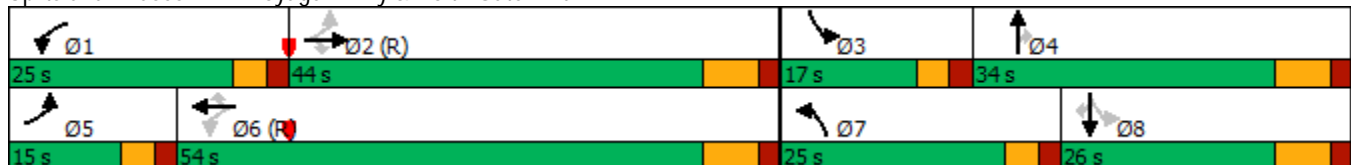

HCM 6th Signalized Intersection Summary
 1: Voyager Pkwy & North Gate Blvd

2024 Background PM

08/29/2022

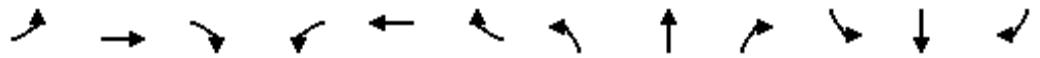

Movement	EBL	EBT	EBR	WBL	WBT	WBR	NBL	NBT	NBR	SBL	SBT	SBR
Lane Configurations	↘	↑↑	↗	↘	↑↑	↗	↘↗	↑	↗	↘	↑	↗
Traffic Volume (veh/h)	28	459	216	328	420	29	269	53	262	31	38	23
Future Volume (veh/h)	28	459	216	328	420	29	269	53	262	31	38	23
Initial Q (Qb), veh	0	0	0	0	0	0	0	0	0	0	0	0
Ped-Bike Adj(A_pbT)	1.00		1.00	1.00		1.00	1.00		1.00	1.00		1.00
Parking Bus, Adj	1.00	1.00	1.00	1.00	1.00	1.00	1.00	1.00	1.00	1.00	1.00	1.00
Work Zone On Approach		No			No			No			No	
Adj Sat Flow, veh/h/ln	1870	1870	1870	1870	1870	1870	1870	1870	1870	1870	1870	1870
Adj Flow Rate, veh/h	30	499	235	357	457	32	292	58	285	34	41	25
Peak Hour Factor	0.92	0.92	0.92	0.92	0.92	0.92	0.92	0.92	0.92	0.92	0.92	0.92
Percent Heavy Veh, %	2	2	2	2	2	2	2	2	2	2	2	2
Cap, veh/h	513	1627	726	545	1988	887	361	368	312	220	215	182
Arrive On Green	0.02	0.46	0.46	0.12	0.56	0.56	0.10	0.20	0.20	0.02	0.12	0.12
Sat Flow, veh/h	1781	3554	1585	1781	3554	1585	3456	1870	1585	1781	1870	1585
Grp Volume(v), veh/h	30	499	235	357	457	32	292	58	285	34	41	25
Grp Sat Flow(s),veh/h/ln	1781	1777	1585	1781	1777	1585	1728	1870	1585	1781	1870	1585
Q Serve(g_s), s	1.1	10.6	11.3	12.1	7.8	1.1	9.9	3.1	21.1	2.0	2.4	1.7
Cycle Q Clear(g_c), s	1.1	10.6	11.3	12.1	7.8	1.1	9.9	3.1	21.1	2.0	2.4	1.7
Prop In Lane	1.00		1.00	1.00		1.00	1.00		1.00	1.00		1.00
Lane Grp Cap(c), veh/h	513	1627	726	545	1988	887	361	368	312	220	215	182
V/C Ratio(X)	0.06	0.31	0.32	0.65	0.23	0.04	0.81	0.16	0.91	0.15	0.19	0.14
Avail Cap(c_a), veh/h	624	1627	726	624	1988	887	576	421	357	357	296	251
HCM Platoon Ratio	1.00	1.00	1.00	1.00	1.00	1.00	1.00	1.00	1.00	1.00	1.00	1.00
Upstream Filter(l)	1.00	1.00	1.00	1.00	1.00	1.00	0.98	0.98	0.98	1.00	1.00	1.00
Uniform Delay (d), s/veh	16.6	20.5	20.7	13.5	13.4	11.9	52.5	39.9	47.2	45.5	48.0	47.7
Incr Delay (d2), s/veh	0.0	0.5	1.2	2.0	0.3	0.1	4.4	0.2	24.9	0.3	0.4	0.3
Initial Q Delay(d3),s/veh	0.0	0.0	0.0	0.0	0.0	0.0	0.0	0.0	0.0	0.0	0.0	0.0
%ile BackOfQ(50%),veh/ln	0.4	4.5	4.4	5.0	3.2	0.4	4.5	1.4	10.5	0.9	1.1	0.7
Unsig. Movement Delay, s/veh												
LnGrp Delay(d),s/veh	16.6	21.0	21.9	15.5	13.6	12.0	57.0	40.1	72.1	45.8	48.5	48.1
LnGrp LOS	B	C	C	B	B	B	E	D	E	D	D	D
Approach Vol, veh/h		764			846			635			100	
Approach Delay, s/veh		21.1			14.4			62.2			47.5	
Approach LOS		C			B			E			D	
Timer - Assigned Phs	1	2	3	4	5	6	7	8				
Phs Duration (G+Y+Rc), s	19.7	61.9	7.7	30.6	7.5	74.1	17.6	20.8				
Change Period (Y+Rc), s	5.0	7.0	5.0	7.0	5.0	7.0	5.0	7.0				
Max Green Setting (Gmax), s	20.0	37.0	12.0	27.0	10.0	47.0	20.0	19.0				
Max Q Clear Time (g_c+l1), s	14.1	13.3	4.0	23.1	3.1	9.8	11.9	4.4				
Green Ext Time (p_c), s	0.6	4.3	0.0	0.5	0.0	3.5	0.6	0.2				
Intersection Summary												
HCM 6th Ctrl Delay			30.9									
HCM 6th LOS			C									

Timings
1: Voyager Pkwy & North Gate Blvd

2024 Total AM
08/29/2022

Lane Group	EBL	EBT	EBR	WBL	WBT	WBR	NBL	NBT	NBR	SBL	SBT	SBR
Lane Configurations												
Traffic Volume (vph)	8	344	203	361	454	14	222	25	225	54	80	41
Future Volume (vph)	8	344	203	361	454	14	222	25	225	54	80	41
Turn Type	pm+pt	NA	Perm	pm+pt	NA	Perm	Prot	NA	Perm	pm+pt	NA	Perm
Protected Phases	5	2		1	6		7	4		3	8	
Permitted Phases	2		2	6		6			4	8		8
Detector Phase	5	2	2	1	6	6	7	4	4	3	8	8
Switch Phase												
Minimum Initial (s)	4.0	10.0	10.0	4.0	10.0	10.0	4.0	4.0	4.0	4.0	4.0	4.0
Minimum Split (s)	9.0	25.0	25.0	9.0	25.0	25.0	9.0	25.0	25.0	9.0	25.0	25.0
Total Split (s)	15.0	44.0	44.0	25.0	54.0	54.0	25.0	34.0	34.0	17.0	26.0	26.0
Total Split (%)	12.5%	36.7%	36.7%	20.8%	45.0%	45.0%	20.8%	28.3%	28.3%	14.2%	21.7%	21.7%
Yellow Time (s)	3.0	5.0	5.0	3.0	5.0	5.0	3.0	5.0	5.0	3.0	5.0	5.0
All-Red Time (s)	2.0	2.0	2.0	2.0	2.0	2.0	2.0	2.0	2.0	2.0	2.0	2.0
Lost Time Adjust (s)	0.0	0.0	0.0	0.0	0.0	0.0	0.0	0.0	0.0	0.0	0.0	0.0
Total Lost Time (s)	5.0	7.0	7.0	5.0	7.0	7.0	5.0	7.0	7.0	5.0	7.0	7.0
Lead/Lag	Lead	Lag	Lag	Lead	Lag	Lag	Lead	Lag	Lag	Lead	Lag	Lag
Lead-Lag Optimize?	Yes	Yes	Yes	Yes	Yes	Yes	Yes	Yes	Yes	Yes	Yes	Yes
Recall Mode	None	C-Max	C-Max	None	C-Max	C-Max	None	None	None	None	None	None
Act Effct Green (s)	64.6	56.9	56.9	81.2	77.0	77.0	13.6	15.5	15.5	19.6	10.9	10.9
Actuated g/C Ratio	0.54	0.47	0.47	0.68	0.64	0.64	0.11	0.13	0.13	0.16	0.09	0.09
v/c Ratio	0.02	0.22	0.25	0.53	0.21	0.01	0.61	0.11	0.58	0.23	0.51	0.13
Control Delay	11.4	22.5	4.5	12.6	11.4	0.0	57.3	44.6	11.5	34.6	61.9	0.8
Queue Delay	0.0	0.0	0.0	0.0	0.0	0.0	0.0	0.0	0.0	0.0	0.0	0.0
Total Delay	11.4	22.5	4.5	12.6	11.4	0.0	57.3	44.6	11.5	34.6	61.9	0.8
LOS	B	C	A	B	B	A	E	D	B	C	E	A
Approach Delay		15.8			11.7			34.8			39.1	
Approach LOS		B			B			C			D	

Intersection Summary

Cycle Length: 120
 Actuated Cycle Length: 120
 Offset: 22 (18%), Referenced to phase 2:EBTL and 6:WBTL, Start of Green
 Natural Cycle: 75
 Control Type: Actuated-Coordinated
 Maximum v/c Ratio: 0.61
 Intersection Signal Delay: 20.6
 Intersection Capacity Utilization 58.3%
 Analysis Period (min) 15
 Intersection LOS: C
 ICU Level of Service B

Splits and Phases: 1: Voyager Pkwy & North Gate Blvd



HCM 6th Signalized Intersection Summary
 1: Voyager Pkwy & North Gate Blvd

2024 Total AM
 08/29/2022



Movement	EBL	EBT	EBR	WBL	WBT	WBR	NBL	NBT	NBR	SBL	SBT	SBR
Lane Configurations	↖	↗	↘	↖	↗	↘	↖	↗	↘	↖	↗	↘
Traffic Volume (veh/h)	8	344	203	361	454	14	222	25	225	54	80	41
Future Volume (veh/h)	8	344	203	361	454	14	222	25	225	54	80	41
Initial Q (Qb), veh	0	0	0	0	0	0	0	0	0	0	0	0
Ped-Bike Adj(A_pbT)	1.00		1.00	1.00		1.00	1.00		1.00	1.00		1.00
Parking Bus, Adj	1.00	1.00	1.00	1.00	1.00	1.00	1.00	1.00	1.00	1.00	1.00	1.00
Work Zone On Approach		No			No			No			No	
Adj Sat Flow, veh/h/ln	1870	1870	1870	1870	1870	1870	1870	1870	1870	1870	1870	1870
Adj Flow Rate, veh/h	9	370	218	388	488	15	239	27	242	58	86	44
Peak Hour Factor	0.93	0.93	0.93	0.93	0.93	0.93	0.93	0.93	0.93	0.93	0.93	0.93
Percent Heavy Veh, %	2	2	2	2	2	2	2	2	2	2	2	2
Cap, veh/h	487	1634	729	622	2068	922	307	319	270	263	225	191
Arrive On Green	0.01	0.46	0.46	0.13	0.58	0.58	0.09	0.17	0.17	0.04	0.12	0.12
Sat Flow, veh/h	1781	3554	1585	1781	3554	1585	3456	1870	1585	1781	1870	1585
Grp Volume(v), veh/h	9	370	218	388	488	15	239	27	242	58	86	44
Grp Sat Flow(s),veh/h/ln	1781	1777	1585	1781	1777	1585	1728	1870	1585	1781	1870	1585
Q Serve(g_s), s	0.3	7.5	10.3	13.1	8.0	0.5	8.1	1.5	17.9	3.4	5.1	3.0
Cycle Q Clear(g_c), s	0.3	7.5	10.3	13.1	8.0	0.5	8.1	1.5	17.9	3.4	5.1	3.0
Prop In Lane	1.00		1.00	1.00		1.00	1.00		1.00	1.00		1.00
Lane Grp Cap(c), veh/h	487	1634	729	622	2068	922	307	319	270	263	225	191
V/C Ratio(X)	0.02	0.23	0.30	0.62	0.24	0.02	0.78	0.08	0.89	0.22	0.38	0.23
Avail Cap(c_a), veh/h	620	1634	729	686	2068	922	576	421	357	372	296	251
HCM Platoon Ratio	1.00	1.00	1.00	1.00	1.00	1.00	1.00	1.00	1.00	1.00	1.00	1.00
Upstream Filter(l)	1.00	1.00	1.00	1.00	1.00	1.00	0.99	0.99	0.99	1.00	1.00	1.00
Uniform Delay (d), s/veh	17.0	19.5	20.3	12.5	12.2	10.6	53.5	41.9	48.7	43.8	48.7	47.7
Incr Delay (d2), s/veh	0.0	0.3	1.1	1.5	0.3	0.0	4.2	0.1	19.7	0.4	1.1	0.6
Initial Q Delay(d3),s/veh	0.0	0.0	0.0	0.0	0.0	0.0	0.0	0.0	0.0	0.0	0.0	0.0
%ile BackOfQ(50%),veh/ln	0.1	3.2	4.0	5.3	3.2	0.2	3.7	0.7	8.5	1.5	2.4	1.2
Unsig. Movement Delay, s/veh												
LnGrp Delay(d),s/veh	17.1	19.9	21.4	14.1	12.4	10.6	57.7	42.0	68.4	44.3	49.7	48.4
LnGrp LOS	B	B	C	B	B	B	E	D	E	D	D	D
Approach Vol, veh/h		597			891			508			188	
Approach Delay, s/veh		20.4			13.1			61.9			47.7	
Approach LOS		C			B			E			D	
Timer - Assigned Phs	1	2	3	4	5	6	7	8				
Phs Duration (G+Y+Rc), s	20.7	62.2	9.7	27.5	6.0	76.8	15.7	21.5				
Change Period (Y+Rc), s	5.0	7.0	5.0	7.0	5.0	7.0	5.0	7.0				
Max Green Setting (Gmax), s	20.0	37.0	12.0	27.0	10.0	47.0	20.0	19.0				
Max Q Clear Time (g_c+l1), s	15.1	12.3	5.4	19.9	2.3	10.0	10.1	7.1				
Green Ext Time (p_c), s	0.6	3.3	0.0	0.5	0.0	3.7	0.6	0.4				
Intersection Summary												
HCM 6th Ctrl Delay			29.4									
HCM 6th LOS			C									

Timings
1: Voyager Pkwy & North Gate Blvd

2024 Total PM
08/29/2022



Lane Group	EBL	EBT	EBR	WBL	WBT	WBR	NBL	NBT	NBR	SBL	SBT	SBR
Lane Configurations	↘	↑↑	↗	↘	↑↑	↗	↘↗	↑	↗	↘	↑	↗
Traffic Volume (vph)	28	459	256	338	420	29	298	53	269	31	38	23
Future Volume (vph)	28	459	256	338	420	29	298	53	269	31	38	23
Turn Type	pm+pt	NA	Perm	pm+pt	NA	Perm	Prot	NA	Perm	pm+pt	NA	Perm
Protected Phases	5	2		1	6		7	4		3	8	
Permitted Phases	2		2	6		6			4	8		8
Detector Phase	5	2	2	1	6	6	7	4	4	3	8	8
Switch Phase												
Minimum Initial (s)	4.0	10.0	10.0	4.0	10.0	10.0	4.0	4.0	4.0	4.0	4.0	4.0
Minimum Split (s)	9.0	25.0	25.0	9.0	25.0	25.0	9.0	25.0	25.0	9.0	25.0	25.0
Total Split (s)	15.0	44.0	44.0	25.0	54.0	54.0	25.0	34.0	34.0	17.0	26.0	26.0
Total Split (%)	12.5%	36.7%	36.7%	20.8%	45.0%	45.0%	20.8%	28.3%	28.3%	14.2%	21.7%	21.7%
Yellow Time (s)	3.0	5.0	5.0	3.0	5.0	5.0	3.0	5.0	5.0	3.0	5.0	5.0
All-Red Time (s)	2.0	2.0	2.0	2.0	2.0	2.0	2.0	2.0	2.0	2.0	2.0	2.0
Lost Time Adjust (s)	0.0	0.0	0.0	0.0	0.0	0.0	0.0	0.0	0.0	0.0	0.0	0.0
Total Lost Time (s)	5.0	7.0	7.0	5.0	7.0	7.0	5.0	7.0	7.0	5.0	7.0	7.0
Lead/Lag	Lead	Lag	Lag	Lead	Lag	Lag	Lead	Lag	Lag	Lead	Lag	Lag
Lead-Lag Optimize?	Yes	Yes	Yes	Yes	Yes	Yes	Yes	Yes	Yes	Yes	Yes	Yes
Recall Mode	None	C-Max	C-Max	None	C-Max	C-Max	None	None	None	None	None	None
Act Effct Green (s)	65.8	57.5	57.5	81.0	72.0	72.0	16.4	19.1	19.1	15.8	8.1	8.1
Actuated g/C Ratio	0.55	0.48	0.48	0.68	0.60	0.60	0.14	0.16	0.16	0.13	0.07	0.07
v/c Ratio	0.06	0.29	0.31	0.57	0.22	0.03	0.69	0.20	0.59	0.17	0.33	0.08
Control Delay	10.5	22.4	4.1	13.2	13.7	0.1	57.3	44.5	10.1	34.0	59.5	0.5
Queue Delay	0.0	0.0	0.0	0.0	0.0	0.0	0.0	0.0	0.0	0.0	0.0	0.0
Total Delay	10.5	22.4	4.1	13.2	13.7	0.1	57.3	44.5	10.1	34.0	59.5	0.5
LOS	B	C	A	B	B	A	E	D	B	C	E	A
Approach Delay		15.6			13.0			35.7			36.1	
Approach LOS		B			B			D			D	

Intersection Summary

Cycle Length: 120
 Actuated Cycle Length: 120
 Offset: 22 (18%), Referenced to phase 2:EBTL and 6:WBTL, Start of Green
 Natural Cycle: 80
 Control Type: Actuated-Coordinated
 Maximum v/c Ratio: 0.69
 Intersection Signal Delay: 21.1
 Intersection LOS: C
 Intersection Capacity Utilization 62.4%
 ICU Level of Service B
 Analysis Period (min) 15

Splits and Phases: 1: Voyager Pkwy & North Gate Blvd



HCM 6th Signalized Intersection Summary
 1: Voyager Pkwy & North Gate Blvd

2024 Total PM
 08/29/2022



Movement	EBL	EBT	EBR	WBL	WBT	WBR	NBL	NBT	NBR	SBL	SBT	SBR
Lane Configurations	↘	↑↑	↗	↘	↑↑	↗	↘↗	↑	↗	↘	↑	↗
Traffic Volume (veh/h)	28	459	256	338	420	29	298	53	269	31	38	23
Future Volume (veh/h)	28	459	256	338	420	29	298	53	269	31	38	23
Initial Q (Qb), veh	0	0	0	0	0	0	0	0	0	0	0	0
Ped-Bike Adj(A_pbT)	1.00		1.00	1.00		1.00	1.00		1.00	1.00		1.00
Parking Bus, Adj	1.00	1.00	1.00	1.00	1.00	1.00	1.00	1.00	1.00	1.00	1.00	1.00
Work Zone On Approach		No			No			No			No	
Adj Sat Flow, veh/h/ln	1870	1870	1870	1870	1870	1870	1870	1870	1870	1870	1870	1870
Adj Flow Rate, veh/h	30	499	278	367	457	32	324	58	292	34	41	25
Peak Hour Factor	0.92	0.92	0.92	0.92	0.92	0.92	0.92	0.92	0.92	0.92	0.92	0.92
Percent Heavy Veh, %	2	2	2	2	2	2	2	2	2	2	2	2
Cap, veh/h	505	1596	712	536	1973	880	394	376	318	214	205	174
Arrive On Green	0.02	0.45	0.45	0.13	0.56	0.56	0.11	0.20	0.20	0.02	0.11	0.11
Sat Flow, veh/h	1781	3554	1585	1781	3554	1585	3456	1870	1585	1781	1870	1585
Grp Volume(v), veh/h	30	499	278	367	457	32	324	58	292	34	41	25
Grp Sat Flow(s),veh/h/ln	1781	1777	1585	1781	1777	1585	1728	1870	1585	1781	1870	1585
Q Serve(g_s), s	1.1	10.8	14.1	12.7	7.9	1.1	11.0	3.1	21.7	2.0	2.4	1.7
Cycle Q Clear(g_c), s	1.1	10.8	14.1	12.7	7.9	1.1	11.0	3.1	21.7	2.0	2.4	1.7
Prop In Lane	1.00		1.00	1.00		1.00	1.00		1.00	1.00		1.00
Lane Grp Cap(c), veh/h	505	1596	712	536	1973	880	394	376	318	214	205	174
V/C Ratio(X)	0.06	0.31	0.39	0.68	0.23	0.04	0.82	0.15	0.92	0.16	0.20	0.14
Avail Cap(c_a), veh/h	616	1596	712	606	1973	880	576	421	357	351	296	251
HCM Platoon Ratio	1.00	1.00	1.00	1.00	1.00	1.00	1.00	1.00	1.00	1.00	1.00	1.00
Upstream Filter(I)	1.00	1.00	1.00	1.00	1.00	1.00	0.97	0.97	0.97	1.00	1.00	1.00
Uniform Delay (d), s/veh	17.1	21.2	22.1	14.0	13.6	12.1	52.0	39.5	47.0	46.0	48.6	48.3
Incr Delay (d2), s/veh	0.0	0.5	1.6	2.7	0.3	0.1	6.0	0.2	25.7	0.3	0.5	0.4
Initial Q Delay(d3),s/veh	0.0	0.0	0.0	0.0	0.0	0.0	0.0	0.0	0.0	0.0	0.0	0.0
%ile BackOfQ(50%),veh/ln	0.5	4.6	5.5	5.3	3.2	0.4	5.1	1.4	10.8	0.9	1.1	0.7
Unsig. Movement Delay, s/veh												
LnGrp Delay(d),s/veh	17.2	21.7	23.7	16.7	13.9	12.2	58.0	39.7	72.7	46.4	49.1	48.7
LnGrp LOS	B	C	C	B	B	B	E	D	E	D	D	D
Approach Vol, veh/h		807			856			674			100	
Approach Delay, s/veh		22.2			15.0			62.8			48.0	
Approach LOS		C			B			E			D	
Timer - Assigned Phs	1	2	3	4	5	6	7	8				
Phs Duration (G+Y+Rc), s	20.3	60.9	7.7	31.1	7.5	73.6	18.7	20.2				
Change Period (Y+Rc), s	5.0	7.0	5.0	7.0	5.0	7.0	5.0	7.0				
Max Green Setting (Gmax), s	20.0	37.0	12.0	27.0	10.0	47.0	20.0	19.0				
Max Q Clear Time (g_c+I1), s	14.7	16.1	4.0	23.7	3.1	9.9	13.0	4.4				
Green Ext Time (p_c), s	0.6	4.4	0.0	0.4	0.0	3.5	0.7	0.2				
Intersection Summary												
HCM 6th Ctrl Delay			32.0									
HCM 6th LOS			C									

Timings
1: Voyager Pkwy & North Gate Blvd

2045 Background AM

08/29/2022

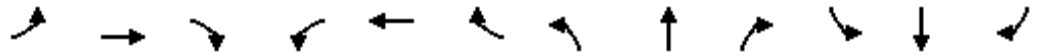

Lane Group	EBL	EBT	EBR	WBL	WBT	WBR	NBL	NBT	NBR	SBL	SBT	SBR
Lane Configurations	↘	↑↑	↗	↘	↑↑	↗	↘↗	↑	↗	↘	↑	↗
Traffic Volume (vph)	8	602	337	640	819	14	312	25	372	54	80	41
Future Volume (vph)	8	602	337	640	819	14	312	25	372	54	80	41
Turn Type	pm+pt	NA	Perm	pm+pt	NA	Perm	Prot	NA	Perm	pm+pt	NA	Perm
Protected Phases	5	2		1	6		7	4		3	8	
Permitted Phases	2		2	6		6			4	8		8
Detector Phase	5	2	2	1	6	6	7	4	4	3	8	8
Switch Phase												
Minimum Initial (s)	4.0	10.0	10.0	4.0	10.0	10.0	4.0	4.0	4.0	4.0	4.0	4.0
Minimum Split (s)	9.0	25.0	25.0	9.0	25.0	25.0	9.0	25.0	25.0	9.0	25.0	25.0
Total Split (s)	9.0	31.0	31.0	47.0	69.0	69.0	17.0	33.0	33.0	9.0	25.0	25.0
Total Split (%)	7.5%	25.8%	25.8%	39.2%	57.5%	57.5%	14.2%	27.5%	27.5%	7.5%	20.8%	20.8%
Yellow Time (s)	3.0	5.0	5.0	3.0	5.0	5.0	3.0	5.0	5.0	3.0	5.0	5.0
All-Red Time (s)	2.0	2.0	2.0	2.0	2.0	2.0	2.0	2.0	2.0	2.0	2.0	2.0
Lost Time Adjust (s)	0.0	0.0	0.0	0.0	0.0	0.0	0.0	0.0	0.0	0.0	0.0	0.0
Total Lost Time (s)	5.0	7.0	7.0	5.0	7.0	7.0	5.0	7.0	7.0	5.0	7.0	7.0
Lead/Lag	Lead	Lag	Lag	Lead	Lag	Lag	Lead	Lag	Lag	Lead	Lag	Lag
Lead-Lag Optimize?	Yes	Yes	Yes	Yes	Yes	Yes	Yes	Yes	Yes	Yes	Yes	Yes
Recall Mode	None	C-Max	C-Max	None	C-Max	C-Max	None	None	None	None	None	None
Act Effct Green (s)	36.6	28.8	28.8	82.9	78.6	78.6	12.0	17.9	17.9	15.1	10.9	10.9
Actuated g/C Ratio	0.30	0.24	0.24	0.69	0.66	0.66	0.10	0.15	0.15	0.13	0.09	0.09
v/c Ratio	0.04	0.76	0.57	0.88	0.38	0.01	0.98	0.10	0.69	0.31	0.51	0.13
Control Delay	16.9	50.8	9.7	38.4	11.7	0.0	97.1	42.5	11.1	40.8	61.9	0.8
Queue Delay	0.0	0.0	0.0	0.0	0.0	0.0	0.0	0.0	0.0	0.0	0.0	0.0
Total Delay	16.9	50.8	9.7	38.4	11.7	0.0	97.1	42.5	11.1	40.8	61.9	0.8
LOS	B	D	A	D	B	A	F	D	B	D	E	A
Approach Delay		35.9			23.2			50.0			41.1	
Approach LOS		D			C			D			D	

Intersection Summary

Cycle Length: 120
 Actuated Cycle Length: 120
 Offset: 22 (18%), Referenced to phase 2:EBTL and 6:WBTL, Start of Green
 Natural Cycle: 110
 Control Type: Actuated-Coordinated
 Maximum v/c Ratio: 0.98
 Intersection Signal Delay: 33.5
 Intersection LOS: C
 Intersection Capacity Utilization 83.5%
 ICU Level of Service E
 Analysis Period (min) 15

Splits and Phases: 1: Voyager Pkwy & North Gate Blvd

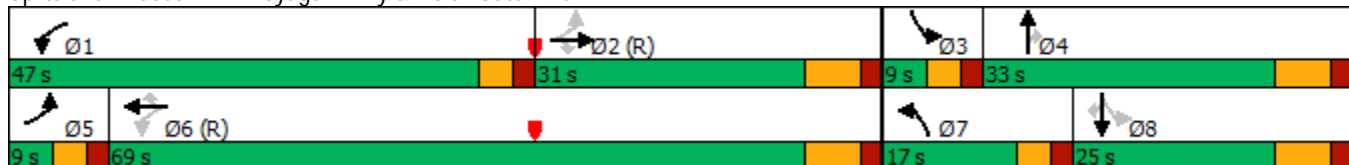

HCM 6th Signalized Intersection Summary
1: Voyager Pkwy & North Gate Blvd

2045 Background AM

08/29/2022

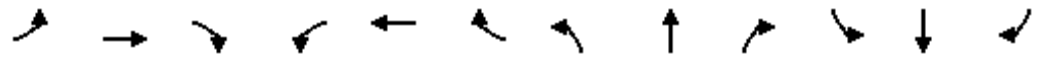

Movement	EBL	EBT	EBR	WBL	WBT	WBR	NBL	NBT	NBR	SBL	SBT	SBR
Lane Configurations	↘	↑↑	↗	↘	↑↑	↗	↘↗	↑	↗	↘	↑	↗
Traffic Volume (veh/h)	8	602	337	640	819	14	312	25	372	54	80	41
Future Volume (veh/h)	8	602	337	640	819	14	312	25	372	54	80	41
Initial Q (Qb), veh	0	0	0	0	0	0	0	0	0	0	0	0
Ped-Bike Adj(A_pbT)	1.00		1.00	1.00		1.00	1.00		1.00	1.00		1.00
Parking Bus, Adj	1.00	1.00	1.00	1.00	1.00	1.00	1.00	1.00	1.00	1.00	1.00	1.00
Work Zone On Approach		No			No			No			No	
Adj Sat Flow, veh/h/ln	1870	1870	1870	1870	1870	1870	1870	1870	1870	1870	1870	1870
Adj Flow Rate, veh/h	9	647	362	688	881	15	335	27	400	58	86	44
Peak Hour Factor	0.93	0.93	0.93	0.93	0.93	0.93	0.93	0.93	0.93	0.93	0.93	0.93
Percent Heavy Veh, %	2	2	2	2	2	2	2	2	2	2	2	2
Cap, veh/h	200	711	317	696	1924	858	346	405	343	263	281	238
Arrive On Green	0.01	0.20	0.20	0.35	0.54	0.54	0.10	0.22	0.22	0.03	0.15	0.15
Sat Flow, veh/h	1781	3554	1585	1781	3554	1585	3456	1870	1585	1781	1870	1585
Grp Volume(v), veh/h	9	647	362	688	881	15	335	27	400	58	86	44
Grp Sat Flow(s),veh/h/ln	1781	1777	1585	1781	1777	1585	1728	1870	1585	1781	1870	1585
Q Serve(g_s), s	0.5	21.4	24.0	41.2	18.1	0.5	11.6	1.4	26.0	3.3	4.9	2.9
Cycle Q Clear(g_c), s	0.5	21.4	24.0	41.2	18.1	0.5	11.6	1.4	26.0	3.3	4.9	2.9
Prop In Lane	1.00		1.00	1.00		1.00	1.00		1.00	1.00		1.00
Lane Grp Cap(c), veh/h	200	711	317	696	1924	858	346	405	343	263	281	238
V/C Ratio(X)	0.05	0.91	1.14	0.99	0.46	0.02	0.97	0.07	1.16	0.22	0.31	0.19
Avail Cap(c_a), veh/h	244	711	317	696	1924	858	346	405	343	263	281	238
HCM Platoon Ratio	1.00	1.00	1.00	1.00	1.00	1.00	1.00	1.00	1.00	1.00	1.00	1.00
Upstream Filter(l)	1.00	1.00	1.00	1.00	1.00	1.00	0.97	0.97	0.97	1.00	1.00	1.00
Uniform Delay (d), s/veh	37.8	46.9	48.0	31.1	16.8	12.7	53.8	37.4	47.0	41.4	45.4	44.6
Incr Delay (d2), s/veh	0.1	17.8	94.7	31.2	0.8	0.0	39.4	0.1	100.6	0.4	0.6	0.4
Initial Q Delay(d3),s/veh	0.0	0.0	0.0	0.0	0.0	0.0	0.0	0.0	0.0	0.0	0.0	0.0
%ile BackOfQ(50%),veh/ln	0.2	11.2	17.8	25.5	7.5	0.2	6.9	0.6	19.8	1.5	2.3	1.2
Unsig. Movement Delay, s/veh												
LnGrp Delay(d),s/veh	37.9	64.8	142.7	62.3	17.6	12.8	93.3	37.4	147.6	41.8	46.1	45.0
LnGrp LOS	D	E	F	E	B	B	F	D	F	D	D	D
Approach Vol, veh/h		1018			1584			762			188	
Approach Delay, s/veh		92.2			37.0			119.8			44.5	
Approach LOS		F			D			F			D	
Timer - Assigned Phs	1	2	3	4	5	6	7	8				
Phs Duration (G+Y+Rc), s	47.0	31.0	9.0	33.0	6.0	72.0	17.0	25.0				
Change Period (Y+Rc), s	5.0	7.0	5.0	7.0	5.0	7.0	5.0	7.0				
Max Green Setting (Gmax), s	42.0	24.0	4.0	26.0	4.0	62.0	12.0	18.0				
Max Q Clear Time (g_c+l1), s	43.2	26.0	5.3	28.0	2.5	20.1	13.6	6.9				
Green Ext Time (p_c), s	0.0	0.0	0.0	0.0	0.0	7.7	0.0	0.4				

Intersection Summary

HCM 6th Ctrl Delay	71.0
HCM 6th LOS	E

Timings
1: Voyager Pkwy & North Gate Blvd

2045 Background PM

08/29/2022

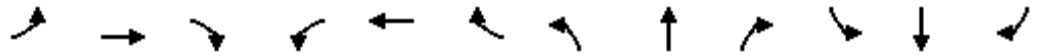

Lane Group	EBL	EBT	EBR	WBL	WBT	WBR	NBL	NBT	NBR	SBL	SBT	SBR
Lane Configurations	↘	↑↑	↗	↘	↑↑	↗	↘↗	↑	↗	↘	↑	↗
Traffic Volume (vph)	28	821	373	578	738	29	477	53	462	31	38	23
Future Volume (vph)	28	821	373	578	738	29	477	53	462	31	38	23
Turn Type	pm+pt	NA	Perm	pm+pt	NA	Perm	Prot	NA	Perm	pm+pt	NA	Perm
Protected Phases	5	2		1	6		7	4		3	8	
Permitted Phases	2		2	6		6			4	8		8
Detector Phase	5	2	2	1	6	6	7	4	4	3	8	8
Switch Phase												
Minimum Initial (s)	4.0	10.0	10.0	4.0	10.0	10.0	4.0	4.0	4.0	4.0	4.0	4.0
Minimum Split (s)	9.0	25.0	25.0	9.0	25.0	25.0	9.0	25.0	25.0	9.0	25.0	25.0
Total Split (s)	9.0	35.0	35.0	38.0	64.0	64.0	22.0	38.0	38.0	9.0	25.0	25.0
Total Split (%)	7.5%	29.2%	29.2%	31.7%	53.3%	53.3%	18.3%	31.7%	31.7%	7.5%	20.8%	20.8%
Yellow Time (s)	3.0	5.0	5.0	3.0	5.0	5.0	3.0	5.0	5.0	3.0	5.0	5.0
All-Red Time (s)	2.0	2.0	2.0	2.0	2.0	2.0	2.0	2.0	2.0	2.0	2.0	2.0
Lost Time Adjust (s)	0.0	0.0	0.0	0.0	0.0	0.0	0.0	0.0	0.0	0.0	0.0	0.0
Total Lost Time (s)	5.0	7.0	7.0	5.0	7.0	7.0	5.0	7.0	7.0	5.0	7.0	7.0
Lead/Lag	Lead	Lag	Lag	Lead	Lag	Lag	Lead	Lag	Lag	Lead	Lag	Lag
Lead-Lag Optimize?	Yes	Yes	Yes	Yes	Yes	Yes	Yes	Yes	Yes	Yes	Yes	Yes
Recall Mode	None	C-Max	C-Max	None	C-Max	C-Max	None	None	None	None	None	None
Act Effct Green (s)	36.3	28.0	28.0	80.3	71.3	71.3	17.0	22.3	22.3	12.7	8.2	8.2
Actuated g/C Ratio	0.30	0.23	0.23	0.67	0.59	0.59	0.14	0.19	0.19	0.11	0.07	0.07
v/c Ratio	0.12	1.08	0.62	0.85	0.38	0.03	1.07	0.17	0.72	0.22	0.32	0.08
Control Delay	16.2	99.2	10.2	39.6	15.3	0.1	108.4	41.6	10.0	36.7	59.2	0.5
Queue Delay	0.0	0.0	0.0	0.0	0.0	0.0	0.0	0.0	0.0	0.0	0.0	0.0
Total Delay	16.2	99.2	10.2	39.6	15.3	0.1	108.4	41.6	10.0	36.7	59.2	0.5
LOS	B	F	B	D	B	A	F	D	B	D	E	A
Approach Delay		70.2			25.4			59.0			36.9	
Approach LOS		E			C			E			D	

Intersection Summary

Cycle Length: 120
 Actuated Cycle Length: 120
 Offset: 22 (18%), Referenced to phase 2:EBTL and 6:WBTL, Start of Green
 Natural Cycle: 140
 Control Type: Actuated-Coordinated
 Maximum v/c Ratio: 1.08
 Intersection Signal Delay: 49.8
 Intersection Capacity Utilization 90.8%
 Analysis Period (min) 15
 Intersection LOS: D
 ICU Level of Service E

Splits and Phases: 1: Voyager Pkwy & North Gate Blvd

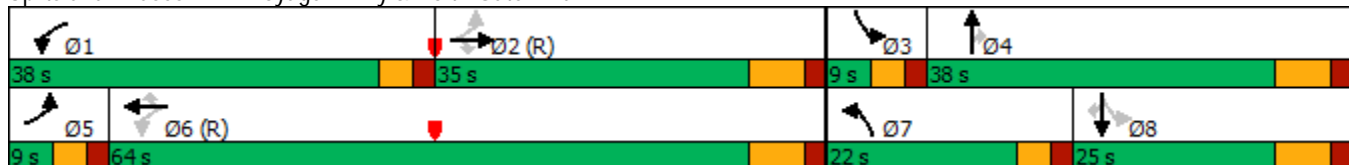

HCM 6th Signalized Intersection Summary
1: Voyager Pkwy & North Gate Blvd

2045 Background PM

08/29/2022

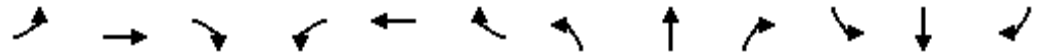

Movement	EBL	EBT	EBR	WBL	WBT	WBR	NBL	NBT	NBR	SBL	SBT	SBR
Lane Configurations	↘	↑↑	↗	↘	↑↑	↗	↘↗	↑	↗	↘	↑	↗
Traffic Volume (veh/h)	28	821	373	578	738	29	477	53	462	31	38	23
Future Volume (veh/h)	28	821	373	578	738	29	477	53	462	31	38	23
Initial Q (Qb), veh	0	0	0	0	0	0	0	0	0	0	0	0
Ped-Bike Adj(A_pbT)	1.00		1.00	1.00		1.00	1.00		1.00	1.00		1.00
Parking Bus, Adj	1.00	1.00	1.00	1.00	1.00	1.00	1.00	1.00	1.00	1.00	1.00	1.00
Work Zone On Approach		No			No			No			No	
Adj Sat Flow, veh/h/ln	1870	1870	1870	1870	1870	1870	1870	1870	1870	1870	1870	1870
Adj Flow Rate, veh/h	30	892	405	628	802	32	518	58	502	34	41	25
Peak Hour Factor	0.92	0.92	0.92	0.92	0.92	0.92	0.92	0.92	0.92	0.92	0.92	0.92
Percent Heavy Veh, %	2	2	2	2	2	2	2	2	2	2	2	2
Cap, veh/h	258	867	387	550	1770	789	490	483	409	219	260	221
Arrive On Green	0.02	0.24	0.24	0.28	0.50	0.50	0.14	0.26	0.26	0.02	0.14	0.14
Sat Flow, veh/h	1781	3554	1585	1781	3554	1585	3456	1870	1585	1781	1870	1585
Grp Volume(v), veh/h	30	892	405	628	802	32	518	58	502	34	41	25
Grp Sat Flow(s),veh/h/ln	1781	1777	1585	1781	1777	1585	1728	1870	1585	1781	1870	1585
Q Serve(g_s), s	1.5	29.3	29.3	33.0	17.6	1.2	17.0	2.8	31.0	2.0	2.3	1.7
Cycle Q Clear(g_c), s	1.5	29.3	29.3	33.0	17.6	1.2	17.0	2.8	31.0	2.0	2.3	1.7
Prop In Lane	1.00		1.00	1.00		1.00	1.00		1.00	1.00		1.00
Lane Grp Cap(c), veh/h	258	867	387	550	1770	789	490	483	409	219	260	221
V/C Ratio(X)	0.12	1.03	1.05	1.14	0.45	0.04	1.06	0.12	1.23	0.16	0.16	0.11
Avail Cap(c_a), veh/h	280	867	387	550	1770	789	490	483	409	238	281	238
HCM Platoon Ratio	1.00	1.00	1.00	1.00	1.00	1.00	1.00	1.00	1.00	1.00	1.00	1.00
Upstream Filter(I)	1.00	1.00	1.00	1.00	1.00	1.00	0.93	0.93	0.93	1.00	1.00	1.00
Uniform Delay (d), s/veh	33.0	45.4	45.4	35.6	19.5	15.4	51.5	34.1	44.5	43.0	45.4	45.2
Incr Delay (d2), s/veh	0.2	38.0	58.5	84.0	0.8	0.1	55.5	0.1	120.4	0.3	0.3	0.2
Initial Q Delay(d3),s/veh	0.0	0.0	0.0	0.0	0.0	0.0	0.0	0.0	0.0	0.0	0.0	0.0
%ile BackOfQ(50%),veh/ln	0.7	17.4	17.7	28.9	7.4	0.5	11.1	1.3	25.7	0.9	1.1	0.7
Unsig. Movement Delay, s/veh												
LnGrp Delay(d),s/veh	33.2	83.4	103.9	119.6	20.4	15.5	107.0	34.2	164.9	43.3	45.7	45.4
LnGrp LOS	C	F	F	F	C	B	F	C	F	D	D	D
Approach Vol, veh/h		1327			1462			1078			100	
Approach Delay, s/veh		88.5			62.9			130.0			44.8	
Approach LOS		F			E			F			D	
Timer - Assigned Phs	1	2	3	4	5	6	7	8				
Phs Duration (G+Y+Rc), s	38.0	36.3	7.7	38.0	7.5	66.8	22.0	23.7				
Change Period (Y+Rc), s	5.0	7.0	5.0	7.0	5.0	7.0	5.0	7.0				
Max Green Setting (Gmax), s	33.0	28.0	4.0	31.0	4.0	57.0	17.0	18.0				
Max Q Clear Time (g_c+I1), s	35.0	31.3	4.0	33.0	3.5	19.6	19.0	4.3				
Green Ext Time (p_c), s	0.0	0.0	0.0	0.0	0.0	6.8	0.0	0.2				

Intersection Summary

HCM 6th Ctrl Delay	89.3
HCM 6th LOS	F

Timings
1: Voyager Pkwy & North Gate Blvd

2045 Total AM
08/29/2022

Lane Group	EBL	EBT	EBR	WBL	WBT	WBR	NBL	NBT	NBR	SBL	SBT	SBR
Lane Configurations												
Traffic Volume (vph)	8	602	349	643	819	14	352	25	382	54	80	41
Future Volume (vph)	8	602	349	643	819	14	352	25	382	54	80	41
Turn Type	pm+pt	NA	Perm	Prot	NA	Perm	Prot	NA	Perm	pm+pt	NA	Perm
Protected Phases	5	2		1	6		7	4		3	8	
Permitted Phases	2		2			6			4	8		8
Detector Phase	5	2	2	1	6	6	7	4	4	3	8	8
Switch Phase												
Minimum Initial (s)	4.0	10.0	10.0	4.0	10.0	10.0	4.0	4.0	4.0	4.0	4.0	4.0
Minimum Split (s)	9.0	25.0	25.0	9.0	25.0	25.0	9.0	25.0	25.0	9.0	25.0	25.0
Total Split (s)	9.0	36.0	36.0	36.0	63.0	63.0	23.0	39.0	39.0	9.0	25.0	25.0
Total Split (%)	7.5%	30.0%	30.0%	30.0%	52.5%	52.5%	19.2%	32.5%	32.5%	7.5%	20.8%	20.8%
Yellow Time (s)	3.0	5.0	5.0	3.0	5.0	5.0	3.0	5.0	5.0	3.0	5.0	5.0
All-Red Time (s)	2.0	2.0	2.0	2.0	2.0	2.0	2.0	2.0	2.0	2.0	2.0	2.0
Lost Time Adjust (s)	0.0	0.0	0.0	0.0	0.0	0.0	0.0	0.0	0.0	0.0	0.0	0.0
Total Lost Time (s)	5.0	7.0	7.0	5.0	7.0	7.0	5.0	7.0	7.0	5.0	7.0	7.0
Lead/Lag	Lead	Lag	Lag	Lead	Lag	Lag	Lead	Lag	Lag	Lead	Lag	Lag
Lead-Lag Optimize?	Yes	Yes	Yes	Yes	Yes	Yes	Yes	Yes	Yes	Yes	Yes	Yes
Recall Mode	None	C-Max	C-Max	None	C-Max	C-Max	None	None	None	None	None	None
Act Effct Green (s)	49.8	42.0	42.0	29.0	73.8	73.8	16.8	22.8	22.8	15.1	10.9	10.9
Actuated g/C Ratio	0.42	0.35	0.35	0.24	0.62	0.62	0.14	0.19	0.19	0.13	0.09	0.09
v/c Ratio	0.03	0.52	0.47	0.83	0.41	0.01	0.79	0.08	0.65	0.31	0.51	0.13
Control Delay	14.5	35.8	5.8	52.5	14.6	0.0	62.1	37.4	8.9	37.3	61.9	0.8
Queue Delay	0.0	0.0	0.0	0.0	0.0	0.0	0.0	0.0	0.0	0.0	0.0	0.0
Total Delay	14.5	35.8	5.8	52.5	14.6	0.0	62.1	37.4	8.9	37.3	61.9	0.8
LOS	B	D	A	D	B	A	E	D	A	D	E	A
Approach Delay		24.7			31.0			34.5			40.0	
Approach LOS		C			C			C			D	

Intersection Summary

Cycle Length: 120
 Actuated Cycle Length: 120
 Offset: 22 (18%), Referenced to phase 2:EBTL and 6:WBT, Start of Green
 Natural Cycle: 90
 Control Type: Actuated-Coordinated
 Maximum v/c Ratio: 0.83
 Intersection Signal Delay: 30.5
 Intersection Capacity Utilization 67.5%
 Analysis Period (min) 15
 Intersection LOS: C
 ICU Level of Service C

Splits and Phases: 1: Voyager Pkwy & North Gate Blvd



HCM 6th Signalized Intersection Summary
 1: Voyager Pkwy & North Gate Blvd

2045 Total AM
 08/29/2022



Movement	EBL	EBT	EBR	WBL	WBT	WBR	NBL	NBT	NBR	SBL	SBT	SBR
Lane Configurations												
Traffic Volume (veh/h)	8	602	349	643	819	14	352	25	382	54	80	41
Future Volume (veh/h)	8	602	349	643	819	14	352	25	382	54	80	41
Initial Q (Qb), veh	0	0	0	0	0	0	0	0	0	0	0	0
Ped-Bike Adj(A_pbT)	1.00		1.00	1.00		1.00	1.00		1.00	1.00		1.00
Parking Bus, Adj	1.00	1.00	1.00	1.00	1.00	1.00	1.00	1.00	1.00	1.00	1.00	1.00
Work Zone On Approach		No			No			No			No	
Adj Sat Flow, veh/h/ln	1870	1870	1870	1870	1870	1870	1870	1870	1870	1870	1870	1870
Adj Flow Rate, veh/h	9	647	375	691	881	15	378	27	411	58	86	44
Peak Hour Factor	0.93	0.93	0.93	0.93	0.93	0.93	0.93	0.93	0.93	0.93	0.93	0.93
Percent Heavy Veh, %	2	2	2	2	2	2	2	2	2	2	2	2
Cap, veh/h	247	984	439	771	1746	779	441	499	423	283	323	273
Arrive On Green	0.01	0.28	0.28	0.22	0.49	0.49	0.13	0.27	0.27	0.03	0.17	0.17
Sat Flow, veh/h	1781	3554	1585	3456	3554	1585	3456	1870	1585	1781	1870	1585
Grp Volume(v), veh/h	9	647	375	691	881	15	378	27	411	58	86	44
Grp Sat Flow(s),veh/h/ln	1781	1777	1585	1728	1777	1585	1728	1870	1585	1781	1870	1585
Q Serve(g_s), s	0.4	19.3	26.9	23.3	20.1	0.6	12.9	1.3	30.8	3.2	4.8	2.8
Cycle Q Clear(g_c), s	0.4	19.3	26.9	23.3	20.1	0.6	12.9	1.3	30.8	3.2	4.8	2.8
Prop In Lane	1.00		1.00	1.00		1.00	1.00		1.00	1.00		1.00
Lane Grp Cap(c), veh/h	247	984	439	771	1746	779	441	499	423	283	323	273
V/C Ratio(X)	0.04	0.66	0.85	0.90	0.50	0.02	0.86	0.05	0.97	0.20	0.27	0.16
Avail Cap(c_a), veh/h	291	984	439	893	1746	779	518	499	423	283	323	273
HCM Platoon Ratio	1.00	1.00	1.00	1.00	1.00	1.00	1.00	1.00	1.00	1.00	1.00	1.00
Upstream Filter(l)	1.00	1.00	1.00	1.00	1.00	1.00	0.97	0.97	0.97	1.00	1.00	1.00
Uniform Delay (d), s/veh	30.8	38.3	41.1	45.3	20.6	15.7	51.3	32.7	43.6	39.1	43.1	42.3
Incr Delay (d2), s/veh	0.1	3.4	18.7	10.7	1.0	0.0	11.6	0.0	35.8	0.4	0.4	0.3
Initial Q Delay(d3),s/veh	0.0	0.0	0.0	0.0	0.0	0.0	0.0	0.0	0.0	0.0	0.0	0.0
%ile BackOfQ(50%),veh/ln	0.2	8.9	12.7	11.1	8.5	0.2	6.3	0.6	16.2	1.4	2.3	1.1
Unsig. Movement Delay, s/veh												
LnGrp Delay(d),s/veh	30.8	41.8	59.8	55.9	21.7	15.7	62.9	32.8	79.4	39.5	43.5	42.5
LnGrp LOS	C	D	E	E	C	B	E	C	E	D	D	D
Approach Vol, veh/h		1031			1587			816			188	
Approach Delay, s/veh		48.2			36.5			70.2			42.0	
Approach LOS		D			D			E			D	
Timer - Assigned Phs	1	2	3	4	5	6	7	8				
Phs Duration (G+Y+Rc), s	31.8	40.2	9.0	39.0	6.0	66.0	20.3	27.7				
Change Period (Y+Rc), s	5.0	7.0	5.0	7.0	5.0	7.0	5.0	7.0				
Max Green Setting (Gmax), s	31.0	29.0	4.0	32.0	4.0	56.0	18.0	18.0				
Max Q Clear Time (g_c+l1), s	25.3	28.9	5.2	32.8	2.4	22.1	14.9	6.8				
Green Ext Time (p_c), s	1.5	0.1	0.0	0.0	0.0	7.5	0.4	0.4				

Intersection Summary

HCM 6th Ctrl Delay	47.7
HCM 6th LOS	D

Timings
1: Voyager Pkwy & North Gate Blvd

2045 Total PM
08/29/2022

Lane Group	EBL	EBT	EBR	WBL	WBT	WBR	NBL	NBT	NBR	SBL	SBT	SBR
Lane Configurations												
Traffic Volume (vph)	28	821	413	588	738	29	506	53	469	31	38	23
Future Volume (vph)	28	821	413	588	738	29	506	53	469	31	38	23
Turn Type	pm+pt	NA	Perm	Prot	NA	Perm	Prot	NA	Perm	pm+pt	NA	Perm
Protected Phases	5	2		1	6		7	4		3	8	
Permitted Phases	2		2			6			4	8		8
Detector Phase	5	2	2	1	6	6	7	4	4	3	8	8
Switch Phase												
Minimum Initial (s)	4.0	10.0	10.0	4.0	10.0	10.0	4.0	4.0	4.0	4.0	4.0	4.0
Minimum Split (s)	9.0	25.0	25.0	9.0	25.0	25.0	9.0	25.0	25.0	9.0	25.0	25.0
Total Split (s)	9.0	25.0	25.0	29.0	45.0	45.0	41.0	42.0	42.0	24.0	25.0	25.0
Total Split (%)	7.5%	20.8%	20.8%	24.2%	37.5%	37.5%	34.2%	35.0%	35.0%	20.0%	20.8%	20.8%
Yellow Time (s)	3.0	5.0	5.0	3.0	5.0	5.0	3.0	5.0	5.0	3.0	5.0	5.0
All-Red Time (s)	2.0	2.0	2.0	2.0	2.0	2.0	2.0	2.0	2.0	2.0	2.0	2.0
Lost Time Adjust (s)	0.0	0.0	0.0	0.0	0.0	0.0	0.0	0.0	0.0	0.0	0.0	0.0
Total Lost Time (s)	5.0	7.0	7.0	5.0	7.0	7.0	5.0	7.0	7.0	5.0	7.0	7.0
Lead/Lag	Lead	Lag	Lag	Lead	Lag	Lag	Lead	Lag	Lag	Lead	Lag	Lag
Lead-Lag Optimize?	Yes	Yes	Yes	Yes	Yes	Yes	Yes	Yes	Yes	Yes	Yes	Yes
Recall Mode	None	C-Max	C-Max	None	C-Max	C-Max	None	None	None	None	None	None
Act Effct Green (s)	45.6	37.1	37.1	28.5	63.5	63.5	24.7	27.6	27.6	15.7	8.1	8.1
Actuated g/C Ratio	0.38	0.31	0.31	0.24	0.53	0.53	0.21	0.23	0.23	0.13	0.07	0.07
v/c Ratio	0.10	0.82	0.60	0.78	0.43	0.03	0.78	0.14	0.67	0.17	0.33	0.08
Control Delay	17.2	47.6	12.3	50.0	21.2	0.1	52.8	35.8	8.0	29.3	59.5	0.5
Queue Delay	0.0	0.0	0.0	0.0	0.0	0.0	0.0	0.0	0.0	0.0	0.0	0.0
Total Delay	17.2	47.6	12.3	50.0	21.2	0.1	52.8	35.8	8.0	29.3	59.5	0.5
LOS	B	D	B	D	C	A	D	D	A	C	E	A
Approach Delay		35.4			33.2			31.5			34.5	
Approach LOS		D			C			C			C	

Intersection Summary

Cycle Length: 120
 Actuated Cycle Length: 120
 Offset: 22 (18%), Referenced to phase 2:EBTL and 6:WBT, Start of Green
 Natural Cycle: 100
 Control Type: Actuated-Coordinated
 Maximum v/c Ratio: 0.82
 Intersection Signal Delay: 33.5
 Intersection LOS: C
 Intersection Capacity Utilization 76.4%
 ICU Level of Service D
 Analysis Period (min) 15

Splits and Phases: 1: Voyager Pkwy & North Gate Blvd

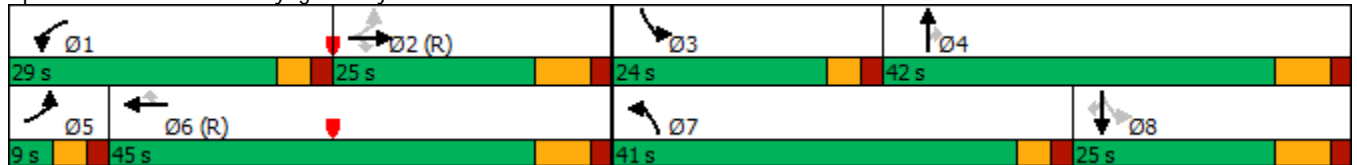

HCM 6th Signalized Intersection Summary
 1: Voyager Pkwy & North Gate Blvd

2045 Total PM
 08/29/2022



Movement	EBL	EBT	EBR	WBL	WBT	WBR	NBL	NBT	NBR	SBL	SBT	SBR
Lane Configurations												
Traffic Volume (veh/h)	28	821	413	588	738	29	506	53	469	31	38	23
Future Volume (veh/h)	28	821	413	588	738	29	506	53	469	31	38	23
Initial Q (Qb), veh	0	0	0	0	0	0	0	0	0	0	0	0
Ped-Bike Adj(A_pbT)	1.00		1.00	1.00		1.00	1.00		1.00	1.00		1.00
Parking Bus, Adj	1.00	1.00	1.00	1.00	1.00	1.00	1.00	1.00	1.00	1.00	1.00	1.00
Work Zone On Approach		No			No			No			No	
Adj Sat Flow, veh/h/ln	1870	1870	1870	1870	1870	1870	1870	1870	1870	1870	1870	1870
Adj Flow Rate, veh/h	30	892	313	639	802	32	550	58	510	34	41	25
Peak Hour Factor	0.92	0.92	0.92	0.92	0.92	0.92	0.92	0.92	0.92	0.92	0.92	0.92
Percent Heavy Veh, %	2	2	2	2	2	2	2	2	2	2	2	2
Cap, veh/h	286	1019	454	687	1651	736	643	546	462	209	240	203
Arrive On Green	0.02	0.29	0.29	0.20	0.46	0.46	0.19	0.29	0.29	0.02	0.13	0.13
Sat Flow, veh/h	1781	3554	1585	3456	3554	1585	3456	1870	1585	1781	1870	1585
Grp Volume(v), veh/h	30	892	313	639	802	32	550	58	510	34	41	25
Grp Sat Flow(s),veh/h/ln	1781	1777	1585	1728	1777	1585	1728	1870	1585	1781	1870	1585
Q Serve(g_s), s	1.4	28.7	21.1	21.8	18.7	1.3	18.5	2.7	35.0	2.0	2.3	1.7
Cycle Q Clear(g_c), s	1.4	28.7	21.1	21.8	18.7	1.3	18.5	2.7	35.0	2.0	2.3	1.7
Prop In Lane	1.00		1.00	1.00		1.00	1.00		1.00	1.00		1.00
Lane Grp Cap(c), veh/h	286	1019	454	687	1651	736	643	546	462	209	240	203
V/C Ratio(X)	0.10	0.88	0.69	0.93	0.49	0.04	0.85	0.11	1.10	0.16	0.17	0.12
Avail Cap(c_a), veh/h	308	1019	454	691	1651	736	1037	546	462	450	281	238
HCM Platoon Ratio	1.00	1.00	1.00	1.00	1.00	1.00	1.00	1.00	1.00	1.00	1.00	1.00
Upstream Filter(l)	1.00	1.00	1.00	1.00	1.00	1.00	0.93	0.93	0.93	1.00	1.00	1.00
Uniform Delay (d), s/veh	29.2	40.8	38.0	47.2	22.2	17.6	47.3	31.1	42.5	44.1	46.6	46.3
Incr Delay (d2), s/veh	0.2	10.5	8.3	19.0	1.0	0.1	3.8	0.1	71.5	0.4	0.3	0.3
Initial Q Delay(d3),s/veh	0.0	0.0	0.0	0.0	0.0	0.0	0.0	0.0	0.0	0.0	0.0	0.0
%ile BackOfQ(50%),veh/ln	0.6	13.9	9.2	11.2	8.0	0.5	8.3	1.3	22.7	0.9	1.1	0.7
Unsig. Movement Delay, s/veh												
LnGrp Delay(d),s/veh	29.4	51.2	46.3	66.3	23.2	17.7	51.1	31.1	114.0	44.5	47.0	46.6
LnGrp LOS	C	D	D	E	C	B	D	C	F	D	D	D
Approach Vol, veh/h		1235			1473			1118				100
Approach Delay, s/veh		49.5			41.8			78.8				46.0
Approach LOS		D			D			E				D
Timer - Assigned Phs	1	2	3	4	5	6	7	8				
Phs Duration (G+Y+Rc), s	28.9	41.4	7.7	42.0	7.5	62.7	27.3	22.4				
Change Period (Y+Rc), s	5.0	7.0	5.0	7.0	5.0	7.0	5.0	7.0				
Max Green Setting (Gmax), s	24.0	18.0	19.0	35.0	4.0	38.0	36.0	18.0				
Max Q Clear Time (g_c+l1), s	23.8	30.7	4.0	37.0	3.4	20.7	20.5	4.3				
Green Ext Time (p_c), s	0.1	0.0	0.0	0.0	0.0	5.4	1.9	0.2				
Intersection Summary												
HCM 6th Ctrl Delay			54.8									
HCM 6th LOS			D									

Intersection												
Int Delay, s/veh	1.1											
Movement	EBL	EBT	EBR	WBL	WBT	WBR	NBL	NBT	NBR	SBL	SBT	SBR
Lane Configurations	↘	↑↑	↗	↘	↑↑	↗		↗	↗		↗	↗
Traffic Vol, veh/h	42	496	5	27	723	35	7	0	11	13	1	34
Future Vol, veh/h	42	496	5	27	723	35	7	0	11	13	1	34
Conflicting Peds, #/hr	0	0	0	0	0	0	0	0	0	0	0	0
Sign Control	Free	Free	Free	Free	Free	Free	Stop	Stop	Stop	Stop	Stop	Stop
RT Channelized	-	-	None	-	-	None	-	-	None	-	-	None
Storage Length	175	-	125	225	-	150	-	-	75	-	-	75
Veh in Median Storage, #	-	0	-	-	0	-	-	2	-	-	2	-
Grade, %	-	0	-	-	0	-	-	0	-	-	0	-
Peak Hour Factor	92	92	92	92	92	92	92	92	92	92	92	92
Heavy Vehicles, %	2	2	2	2	2	2	2	2	2	2	2	2
Mvmt Flow	46	539	5	29	786	38	8	0	12	14	1	37

Major/Minor	Major1			Major2			Minor1			Minor2		
Conflicting Flow All	824	0	0	544	0	0	1083	1513	270	1206	1480	393
Stage 1	-	-	-	-	-	-	631	631	-	844	844	-
Stage 2	-	-	-	-	-	-	452	882	-	362	636	-
Critical Hdwy	4.14	-	-	4.14	-	-	7.54	6.54	6.94	7.54	6.54	6.94
Critical Hdwy Stg 1	-	-	-	-	-	-	6.54	5.54	-	6.54	5.54	-
Critical Hdwy Stg 2	-	-	-	-	-	-	6.54	5.54	-	6.54	5.54	-
Follow-up Hdwy	2.22	-	-	2.22	-	-	3.52	4.02	3.32	3.52	4.02	3.32
Pot Cap-1 Maneuver	802	-	-	1313	-	-	280	153	*893	*219	161	606
Stage 1	-	-	-	-	-	-	712	651	-	*324	377	-
Stage 2	-	-	-	-	-	-	557	362	-	*842	647	-
Platoon blocked, %		-	-	1	-	-	1	1	1	1	1	
Mov Cap-1 Maneuver	802	-	-	1313	-	-	247	141	*893	*203	148	606
Mov Cap-2 Maneuver	-	-	-	-	-	-	410	279	-	*288	319	-
Stage 1	-	-	-	-	-	-	671	614	-	*306	369	-
Stage 2	-	-	-	-	-	-	510	354	-	*783	610	-

Approach	EB	WB	NB	SB
HCM Control Delay, s	0.8	0.3	11	13.3
HCM LOS			B	B

Minor Lane/Major Mvmt	NBLn1	NBLn2	EBL	EBT	EBR	WBL	WBT	WBR	SBLn1	SBLn2
Capacity (veh/h)	410	893	802	-	-	1313	-	-	290	606
HCM Lane V/C Ratio	0.019	0.013	0.057	-	-	0.022	-	-	0.052	0.061
HCM Control Delay (s)	13.9	9.1	9.8	-	-	7.8	-	-	18.1	11.3
HCM Lane LOS	B	A	A	-	-	A	-	-	C	B
HCM 95th %tile Q(veh)	0.1	0	0.2	-	-	0.1	-	-	0.2	0.2

Notes
 -: Volume exceeds capacity \$: Delay exceeds 300s +: Computation Not Defined *: All major volume in platoon

Intersection												
Int Delay, s/veh	1.3											
Movement	EBL	EBT	EBR	WBL	WBT	WBR	NBL	NBT	NBR	SBL	SBT	SBR
Lane Configurations	↖	↗	↘	↖	↗	↘		↖	↗		↖	↗
Traffic Vol, veh/h	46	640	13	51	640	17	2	1	18	20	3	48
Future Vol, veh/h	46	640	13	51	640	17	2	1	18	20	3	48
Conflicting Peds, #/hr	0	0	0	0	0	0	0	0	0	0	0	0
Sign Control	Free	Free	Free	Free	Free	Free	Stop	Stop	Stop	Stop	Stop	Stop
RT Channelized	-	-	None	-	-	None	-	-	None	-	-	None
Storage Length	175	-	125	225	-	150	-	-	75	-	-	75
Veh in Median Storage, #	-	0	-	-	0	-	-	2	-	-	2	-
Grade, %	-	0	-	-	0	-	-	0	-	-	0	-
Peak Hour Factor	93	93	93	93	93	93	93	93	93	93	93	93
Heavy Vehicles, %	2	2	2	2	2	2	2	2	2	2	2	2
Mvmt Flow	49	688	14	55	688	18	2	1	19	22	3	52

Major/Minor	Major1			Major2			Minor1			Minor2		
Conflicting Flow All	706	0	0	702	0	0	1242	1602	344	1241	1598	344
Stage 1	-	-	-	-	-	-	786	786	-	798	798	-
Stage 2	-	-	-	-	-	-	456	816	-	443	800	-
Critical Hdwy	4.14	-	-	4.14	-	-	7.54	6.54	6.94	7.54	6.54	6.94
Critical Hdwy Stg 1	-	-	-	-	-	-	6.54	5.54	-	6.54	5.54	-
Critical Hdwy Stg 2	-	-	-	-	-	-	6.54	5.54	-	6.54	5.54	-
Follow-up Hdwy	2.22	-	-	2.22	-	-	3.52	4.02	3.32	3.52	4.02	3.32
Pot Cap-1 Maneuver	888	-	-	*1219	-	-	260	150	*815	*261	150	652
Stage 1	-	-	-	-	-	-	713	637	-	*346	396	-
Stage 2	-	-	-	-	-	-	554	389	-	*768	625	-
Platoon blocked, %		-	-	1	-	-	1	1	1	1	1	
Mov Cap-1 Maneuver	888	-	-	*1219	-	-	220	135	*815	*235	136	652
Mov Cap-2 Maneuver	-	-	-	-	-	-	385	287	-	*307	316	-
Stage 1	-	-	-	-	-	-	673	602	-	*327	378	-
Stage 2	-	-	-	-	-	-	483	371	-	*707	591	-

Approach	EB			WB			NB			SB		
HCM Control Delay, s	0.6			0.6			10.4			13.2		
HCM LOS							B			B		

Minor Lane/Major Mvmt	NBLn1	NBLn2	EBL	EBT	EBR	WBL	WBT	WBR	SBLn1	SBLn2
Capacity (veh/h)	346	815	888	-	-	*1219	-	-	308	652
HCM Lane V/C Ratio	0.009	0.024	0.056	-	-	0.045	-	-	0.08	0.079
HCM Control Delay (s)	15.5	9.5	9.3	-	-	8.1	-	-	17.7	11
HCM Lane LOS		C	A	A	-	-	A	-	C	B
HCM 95th %tile Q(veh)		0	0.1	0.2	-	-	0.1	-	0.3	0.3

Notes
 -: Volume exceeds capacity \$: Delay exceeds 300s +: Computation Not Defined *: All major volume in platoon

Intersection												
Int Delay, s/veh	1											
Movement	EBL	EBT	EBR	WBL	WBT	WBR	NBL	NBT	NBR	SBL	SBT	SBR
Lane Configurations	↘	↑↑	↗	↘	↑↑	↗		↗	↗		↗	↗
Traffic Vol, veh/h	42	569	5	27	787	35	7	0	11	13	1	34
Future Vol, veh/h	42	569	5	27	787	35	7	0	11	13	1	34
Conflicting Peds, #/hr	0	0	0	0	0	0	0	0	0	0	0	0
Sign Control	Free	Free	Free	Free	Free	Free	Stop	Stop	Stop	Stop	Stop	Stop
RT Channelized	-	-	None	-	-	None	-	-	None	-	-	None
Storage Length	175	-	125	225	-	150	-	-	75	-	-	75
Veh in Median Storage, #	-	0	-	-	0	-	-	2	-	-	2	-
Grade, %	-	0	-	-	0	-	-	0	-	-	0	-
Peak Hour Factor	92	92	92	92	92	92	92	92	92	92	92	92
Heavy Vehicles, %	2	2	2	2	2	2	2	2	2	2	2	2
Mvmt Flow	46	618	5	29	855	38	8	0	12	14	1	37

Major/Minor	Major1		Major2		Minor1			Minor2				
Conflicting Flow All	893	0	0	623	0	0	1196	1661	309	1314	1628	428
Stage 1	-	-	-	-	-	-	710	710	-	913	913	-
Stage 2	-	-	-	-	-	-	486	951	-	401	715	-
Critical Hdwy	4.14	-	-	4.14	-	-	7.54	6.54	6.94	7.54	6.54	6.94
Critical Hdwy Stg 1	-	-	-	-	-	-	6.54	5.54	-	6.54	5.54	-
Critical Hdwy Stg 2	-	-	-	-	-	-	6.54	5.54	-	6.54	5.54	-
Follow-up Hdwy	2.22	-	-	2.22	-	-	3.52	4.02	3.32	3.52	4.02	3.32
Pot Cap-1 Maneuver	755	-	-	*1258	-	-	263	128	*841	*204	137	575
Stage 1	-	-	-	-	-	-	742	662	-	*294	350	-
Stage 2	-	-	-	-	-	-	531	336	-	*793	657	-
Platoon blocked, %		-	-	1	-	-	1	1	1	1	1	
Mov Cap-1 Maneuver	755	-	-	*1258	-	-	230	117	*841	*189	125	575
Mov Cap-2 Maneuver	-	-	-	-	-	-	392	256	-	*260	298	-
Stage 1	-	-	-	-	-	-	697	621	-	*276	342	-
Stage 2	-	-	-	-	-	-	484	328	-	*734	617	-

Approach	EB	WB	NB	SB
HCM Control Delay, s	0.7	0.3	11.3	14
HCM LOS			B	B

Minor Lane/Major Mvmt	NBLn1	NBLn2	EBL	EBT	EBR	WBL	WBT	WBR	SBLn1	SBLn2
Capacity (veh/h)	392	841	755	-	-	*1258	-	-	262	575
HCM Lane V/C Ratio	0.019	0.014	0.06	-	-	0.023	-	-	0.058	0.064
HCM Control Delay (s)	14.4	9.3	10.1	-	-	7.9	-	-	19.6	11.7
HCM Lane LOS	B	A	B	-	-	A	-	-	C	B
HCM 95th %tile Q(veh)	0.1	0	0.2	-	-	0.1	-	-	0.2	0.2

Notes
 -: Volume exceeds capacity \$: Delay exceeds 300s +: Computation Not Defined *: All major volume in platoon

Intersection												
Int Delay, s/veh	1.3											
Movement	EBL	EBT	EBR	WBL	WBT	WBR	NBL	NBT	NBR	SBL	SBT	SBR
Lane Configurations	↘	↑↑	↗	↘	↑↑	↗		↗	↗		↗	↗
Traffic Vol, veh/h	46	710	13	52	722	17	2	1	18	20	3	48
Future Vol, veh/h	46	710	13	52	722	17	2	1	18	20	3	48
Conflicting Peds, #/hr	0	0	0	0	0	0	0	0	0	0	0	0
Sign Control	Free	Free	Free	Free	Free	Free	Stop	Stop	Stop	Stop	Stop	Stop
RT Channelized	-	-	None	-	-	None	-	-	None	-	-	None
Storage Length	175	-	125	225	-	150	-	-	75	-	-	75
Veh in Median Storage, #	-	0	-	-	0	-	-	2	-	-	2	-
Grade, %	-	0	-	-	0	-	-	0	-	-	0	-
Peak Hour Factor	93	93	93	93	93	93	93	93	93	93	93	93
Heavy Vehicles, %	2	2	2	2	2	2	2	2	2	2	2	2
Mvmt Flow	49	763	14	56	776	18	2	1	19	22	3	52

Major/Minor	Major1		Major2		Minor1			Minor2				
Conflicting Flow All	794	0	0	777	0	0	1363	1767	382	1368	1763	388
Stage 1	-	-	-	-	-	-	861	861	-	888	888	-
Stage 2	-	-	-	-	-	-	502	906	-	480	875	-
Critical Hdwy	4.14	-	-	4.14	-	-	7.54	6.54	6.94	7.54	6.54	6.94
Critical Hdwy Stg 1	-	-	-	-	-	-	6.54	5.54	-	6.54	5.54	-
Critical Hdwy Stg 2	-	-	-	-	-	-	6.54	5.54	-	6.54	5.54	-
Follow-up Hdwy	2.22	-	-	2.22	-	-	3.52	4.02	3.32	3.52	4.02	3.32
Pot Cap-1 Maneuver	823	-	-	*1180	-	-	218	115	*789	*215	117	611
Stage 1	-	-	-	-	-	-	685	613	-	*305	360	-
Stage 2	-	-	-	-	-	-	520	353	-	*744	601	-
Platoon blocked, %		-	-	1	-	-	1	1	1	1	1	
Mov Cap-1 Maneuver	823	-	-	*1180	-	-	182	103	*789	*192	104	611
Mov Cap-2 Maneuver	-	-	-	-	-	-	352	255	-	*269	285	-
Stage 1	-	-	-	-	-	-	644	576	-	*287	343	-
Stage 2	-	-	-	-	-	-	449	336	-	*681	565	-

Approach	EB		WB		NB		SB	
HCM Control Delay, s	0.6		0.5		10.7		14.1	
HCM LOS					B		B	

Minor Lane/Major Mvmt	NBLn1	NBLn2	EBL	EBT	EBR	WBL	WBT	WBR	SBLn1	SBLn2
Capacity (veh/h)	312	789	823	-	- * 1180	-	-	-	271	611
HCM Lane V/C Ratio	0.01	0.025	0.06	-	- 0.047	-	-	-	0.091	0.084
HCM Control Delay (s)	16.7	9.7	9.7	-	- 8.2	-	-	-	19.6	11.4
HCM Lane LOS		C	A	A	-	- A	-	-	C	B
HCM 95th %tile Q(veh)		0	0.1	0.2	-	- 0.1	-	-	0.3	0.3

Notes
 -: Volume exceeds capacity \$: Delay exceeds 300s +: Computation Not Defined *: All major volume in platoon

Intersection												
Int Delay, s/veh	1.2											
Movement	EBL	EBT	EBR	WBL	WBT	WBR	NBL	NBT	NBR	SBL	SBT	SBR
Lane Configurations	↘	↑↑	↗	↘	↑↑	↗		↗	↗		↗	↗
Traffic Vol, veh/h	42	579	5	35	790	35	7	0	36	13	1	34
Future Vol, veh/h	42	579	5	35	790	35	7	0	36	13	1	34
Conflicting Peds, #/hr	0	0	0	0	0	0	0	0	0	0	0	0
Sign Control	Free	Free	Free	Free	Free	Free	Stop	Stop	Stop	Stop	Stop	Stop
RT Channelized	-	-	None	-	-	None	-	-	None	-	-	None
Storage Length	175	-	125	225	-	150	-	-	75	-	-	75
Veh in Median Storage, #	-	0	-	-	0	-	-	2	-	-	2	-
Grade, %	-	0	-	-	0	-	-	0	-	-	0	-
Peak Hour Factor	92	92	92	92	92	92	92	92	92	92	92	92
Heavy Vehicles, %	2	2	2	2	2	2	2	2	2	2	2	2
Mvmt Flow	46	629	5	38	859	38	8	0	39	14	1	37

Major/Minor	Major1			Major2			Minor1			Minor2		
Conflicting Flow All	897	0	0	634	0	0	1227	1694	315	1342	1661	430
Stage 1	-	-	-	-	-	-	721	721	-	935	935	-
Stage 2	-	-	-	-	-	-	506	973	-	407	726	-
Critical Hdwy	4.14	-	-	4.14	-	-	7.54	6.54	6.94	7.54	6.54	6.94
Critical Hdwy Stg 1	-	-	-	-	-	-	6.54	5.54	-	6.54	5.54	-
Critical Hdwy Stg 2	-	-	-	-	-	-	6.54	5.54	-	6.54	5.54	-
Follow-up Hdwy	2.22	-	-	2.22	-	-	3.52	4.02	3.32	3.52	4.02	3.32
Pot Cap-1 Maneuver	753	-	-	*1258	-	-	246	121	*841	*193	128	573
Stage 1	-	-	-	-	-	-	728	652	-	*285	342	-
Stage 2	-	-	-	-	-	-	517	329	-	*793	648	-
Platoon blocked, %		-	-	1	-	-	1	1	1	1	1	
Mov Cap-1 Maneuver	753	-	-	*1258	-	-	214	110	*841	*171	117	573
Mov Cap-2 Maneuver	-	-	-	-	-	-	377	248	-	*252	288	-
Stage 1	-	-	-	-	-	-	684	613	-	*268	332	-
Stage 2	-	-	-	-	-	-	468	319	-	*710	609	-

Approach	EB			WB			NB			SB		
HCM Control Delay, s	0.7			0.3			10.3			14.2		
HCM LOS							B			B		

Minor Lane/Major Mvmt	NBLn1	NBLn2	EBL	EBT	EBR	WBL	WBT	WBR	SBLn1	SBLn2
Capacity (veh/h)	377	841	753	-	-	*1258	-	-	254	573
HCM Lane V/C Ratio	0.02	0.047	0.061	-	-	0.03	-	-	0.06	0.064
HCM Control Delay (s)	14.7	9.5	10.1	-	-	8	-	-	20.1	11.7
HCM Lane LOS	B	A	B	-	-	A	-	-	C	B
HCM 95th %tile Q(veh)	0.1	0.1	0.2	-	-	0.1	-	-	0.2	0.2

Notes
 -: Volume exceeds capacity \$: Delay exceeds 300s +: Computation Not Defined *: All major volume in platoon

Intersection												
Int Delay, s/veh	1.5											
Movement	EBL	EBT	EBR	WBL	WBT	WBR	NBL	NBT	NBR	SBL	SBT	SBR
Lane Configurations	↘	↑↑	↗	↘	↑↑	↗		↘	↗		↘	↗
Traffic Vol, veh/h	46	717	13	77	732	17	2	1	36	20	3	48
Future Vol, veh/h	46	717	13	77	732	17	2	1	36	20	3	48
Conflicting Peds, #/hr	0	0	0	0	0	0	0	0	0	0	0	0
Sign Control	Free	Free	Free	Free	Free	Free	Stop	Stop	Stop	Stop	Stop	Stop
RT Channelized	-	-	None	-	-	None	-	-	None	-	-	None
Storage Length	175	-	125	225	-	150	-	-	75	-	-	75
Veh in Median Storage, #	-	0	-	-	0	-	-	2	-	-	2	-
Grade, %	-	0	-	-	0	-	-	0	-	-	0	-
Peak Hour Factor	93	93	93	93	93	93	93	93	93	93	93	93
Heavy Vehicles, %	2	2	2	2	2	2	2	2	2	2	2	2
Mvmt Flow	49	771	14	83	787	18	2	1	39	22	3	52

Major/Minor	Major1		Major2		Minor1			Minor2				
Conflicting Flow All	805	0	0	785	0	0	1430	1840	386	1437	1836	394
Stage 1	-	-	-	-	-	-	869	869	-	953	953	-
Stage 2	-	-	-	-	-	-	561	971	-	484	883	-
Critical Hdwy	4.14	-	-	4.14	-	-	7.54	6.54	6.94	7.54	6.54	6.94
Critical Hdwy Stg 1	-	-	-	-	-	-	6.54	5.54	-	6.54	5.54	-
Critical Hdwy Stg 2	-	-	-	-	-	-	6.54	5.54	-	6.54	5.54	-
Follow-up Hdwy	2.22	-	-	2.22	-	-	3.52	4.02	3.32	3.52	4.02	3.32
Pot Cap-1 Maneuver	815	-	-	*1180	-	-	186	101	*789	*184	101	605
Stage 1	-	-	-	-	-	-	675	606	-	*278	336	-
Stage 2	-	-	-	-	-	-	480	329	-	*744	594	-
Platoon blocked, %		-	-	1	-	-	1	1	1	1	1	
Mov Cap-1 Maneuver	815	-	-	*1180	-	-	153	88	*789	*157	88	605
Mov Cap-2 Maneuver	-	-	-	-	-	-	316	231	-	*243	259	-
Stage 1	-	-	-	-	-	-	634	570	-	*261	312	-
Stage 2	-	-	-	-	-	-	404	306	-	*663	559	-

Approach	EB	WB	NB	SB
HCM Control Delay, s	0.6	0.8	10.4	14.7
HCM LOS			B	B

Minor Lane/Major Mvmt	NBLn1	NBLn2	EBL	EBT	EBR	WBL	WBT	WBR	SBLn1	SBLn2
Capacity (veh/h)	281	789	815	-	-	*1180	-	-	245	605
HCM Lane V/C Ratio	0.011	0.049	0.061	-	-	0.07	-	-	0.101	0.085
HCM Control Delay (s)	18	9.8	9.7	-	-	8.3	-	-	21.3	11.5
HCM Lane LOS	C	A	A	-	-	A	-	-	C	B
HCM 95th %tile Q(veh)	0	0.2	0.2	-	-	0.2	-	-	0.3	0.3

Notes
 -: Volume exceeds capacity \$: Delay exceeds 300s +: Computation Not Defined *: All major volume in platoon

Intersection												
Int Delay, s/veh	1											
Movement	EBL	EBT	EBR	WBL	WBT	WBR	NBL	NBT	NBR	SBL	SBT	SBR
Lane Configurations	↘	↑↑	↗	↘	↑↑	↗		↗	↗		↗	↗
Traffic Vol, veh/h	42	993	6	30	1413	35	8	0	12	13	1	34
Future Vol, veh/h	42	993	6	30	1413	35	8	0	12	13	1	34
Conflicting Peds, #/hr	0	0	0	0	0	0	0	0	0	0	0	0
Sign Control	Free	Free	Free	Free	Free	Free	Stop	Stop	Stop	Stop	Stop	Stop
RT Channelized	-	-	None	-	-	None	-	-	None	-	-	None
Storage Length	175	-	125	225	-	150	-	-	75	-	-	75
Veh in Median Storage, #	-	0	-	-	0	-	-	2	-	-	2	-
Grade, %	-	0	-	-	0	-	-	0	-	-	0	-
Peak Hour Factor	92	92	92	92	92	92	92	92	92	92	92	92
Heavy Vehicles, %	2	2	2	2	2	2	2	2	2	2	2	2
Mvmt Flow	46	1079	7	33	1536	38	9	0	13	14	1	37

Major/Minor	Major1		Major2		Minor1			Minor2				
Conflicting Flow All	1574	0	0	1086	0	0	2006	2811	540	2234	2780	768
Stage 1	-	-	-	-	-	-	1171	1171	-	1602	1602	-
Stage 2	-	-	-	-	-	-	835	1640	-	632	1178	-
Critical Hdwy	4.14	-	-	4.14	-	-	7.54	6.54	6.94	7.54	6.54	6.94
Critical Hdwy Stg 1	-	-	-	-	-	-	6.54	5.54	-	6.54	5.54	-
Critical Hdwy Stg 2	-	-	-	-	-	-	6.54	5.54	-	6.54	5.54	-
Follow-up Hdwy	2.22	-	-	2.22	-	-	3.52	4.02	3.32	3.52	4.02	3.32
Pot Cap-1 Maneuver	415	-	-	*985	-	-	*64	*13	*659	*34	14	344
Stage 1	-	-	-	-	-	-	*621	*544	-	*110	163	-
Stage 2	-	-	-	-	-	-	*328	*157	-	*621	542	-
Platoon blocked, %		-	-	1	-	-	1	1	1	1	1	
Mov Cap-1 Maneuver	415	-	-	*985	-	-	*51	*11	*659	*30	12	344
Mov Cap-2 Maneuver	-	-	-	-	-	-	*207	*98	-	*92	139	-
Stage 1	-	-	-	-	-	-	*552	*484	-	*98	157	-
Stage 2	-	-	-	-	-	-	*281	*152	-	*541	482	-

Approach	EB		WB		NB		SB	
HCM Control Delay, s	0.6		0.2		15.6		26.6	
HCM LOS					C		D	

Minor Lane/Major Mvmt	NBLn1	NBLn2	EBL	EBT	EBR	WBL	WBT	WBR	SBLn1	SBLn2
Capacity (veh/h)	207	659	415	-	-	*985	-	-	94	344
HCM Lane V/C Ratio	0.042	0.02	0.11	-	-	0.033	-	-	0.162	0.107
HCM Control Delay (s)	23.2	10.6	14.7	-	-	8.8	-	-	50.6	16.7
HCM Lane LOS	C	B	B	-	-	A	-	-	F	C
HCM 95th %tile Q(veh)	0.1	0.1	0.4	-	-	0.1	-	-	0.5	0.4

Notes
 -: Volume exceeds capacity \$: Delay exceeds 300s +: Computation Not Defined *: All major volume in platoon

Intersection												
Int Delay, s/veh	1.2											
Movement	EBL	EBT	EBR	WBL	WBT	WBR	NBL	NBT	NBR	SBL	SBT	SBR
Lane Configurations	↘	↗	↘	↘	↗	↘		↗	↘		↗	↘
Traffic Vol, veh/h	46	1262	15	57	1267	17	2	1	20	20	3	48
Future Vol, veh/h	46	1262	15	57	1267	17	2	1	20	20	3	48
Conflicting Peds, #/hr	0	0	0	0	0	0	0	0	0	0	0	0
Sign Control	Free	Free	Free	Free	Free	Free	Stop	Stop	Stop	Stop	Stop	Stop
RT Channelized	-	-	None	-	-	None	-	-	None	-	-	None
Storage Length	175	-	125	225	-	150	-	-	75	-	-	75
Veh in Median Storage, #	-	0	-	-	0	-	-	2	-	-	2	-
Grade, %	-	0	-	-	0	-	-	0	-	-	0	-
Peak Hour Factor	93	93	93	93	93	93	93	93	93	93	93	93
Heavy Vehicles, %	2	2	2	2	2	2	2	2	2	2	2	2
Mvmt Flow	49	1357	16	61	1362	18	2	1	22	22	3	52

Major/Minor	Major1		Major2		Minor1		Minor2					
Conflicting Flow All	1380	0	0	1373	0	0	2260	2957	679	2261	2955	681
Stage 1	-	-	-	-	-	-	1455	1455	-	1484	1484	-
Stage 2	-	-	-	-	-	-	805	1502	-	777	1471	-
Critical Hdwy	4.14	-	-	4.14	-	-	7.54	6.54	6.94	7.54	6.54	6.94
Critical Hdwy Stg 1	-	-	-	-	-	-	6.54	5.54	-	6.54	5.54	-
Critical Hdwy Stg 2	-	-	-	-	-	-	6.54	5.54	-	6.54	5.54	-
Follow-up Hdwy	2.22	-	-	2.22	-	-	3.52	4.02	3.32	3.52	4.02	3.32
Pot Cap-1 Maneuver	493	-	-	*829	-	-	*39	*8	*554	*39	8	393
Stage 1	-	-	-	-	-	-	*523	*458	-	*131	187	-
Stage 2	-	-	-	-	-	-	*342	*183	-	*523	453	-
Platoon blocked, %		-	-	1	-	-	1	1	1	1	1	
Mov Cap-1 Maneuver	493	-	-	*829	-	-	*29	*6	*554	*32	6	393
Mov Cap-2 Maneuver	-	-	-	-	-	-	*189	*108	-	*108	142	-
Stage 1	-	-	-	-	-	-	*471	*413	-	*118	173	-
Stage 2	-	-	-	-	-	-	*270	*169	-	*451	408	-

Approach	EB		WB		NB		SB	
HCM Control Delay, s	0.5		0.4		14.1		25.5	
HCM LOS					B		D	

Minor Lane/Major Mvmt	NBLn1	NBLn2	EBL	EBT	EBR	WBL	WBT	WBR	SBLn1	SBLn2
Capacity (veh/h)	151	554	493	-	-	*829	-	-	111	393
HCM Lane V/C Ratio	0.021	0.039	0.1	-	-	0.074	-	-	0.223	0.131
HCM Control Delay (s)	29.4	11.8	13.1	-	-	9.7	-	-	46.5	15.5
HCM Lane LOS	D	B	B	-	-	A	-	-	E	C
HCM 95th %tile Q(veh)	0.1	0.1	0.3	-	-	0.2	-	-	0.8	0.4

Notes
 -: Volume exceeds capacity \$: Delay exceeds 300s +: Computation Not Defined *: All major volume in platoon

Intersection												
Int Delay, s/veh	1.1											
Movement	EBL	EBT	EBR	WBL	WBT	WBR	NBL	NBT	NBR	SBL	SBT	SBR
Lane Configurations	↘	↑↑	↗	↘	↑↑	↗		↗	↗		↗	↗
Traffic Vol, veh/h	42	1003	6	38	1416	35	8	0	37	13	1	34
Future Vol, veh/h	42	1003	6	38	1416	35	8	0	37	13	1	34
Conflicting Peds, #/hr	0	0	0	0	0	0	0	0	0	0	0	0
Sign Control	Free	Free	Free	Free	Free	Free	Stop	Stop	Stop	Stop	Stop	Stop
RT Channelized	-	-	None	-	-	None	-	-	None	-	-	None
Storage Length	175	-	125	225	-	150	-	-	75	-	-	75
Veh in Median Storage, #	-	0	-	-	0	-	-	2	-	-	2	-
Grade, %	-	0	-	-	0	-	-	0	-	-	0	-
Peak Hour Factor	92	92	92	92	92	92	92	92	92	92	92	92
Heavy Vehicles, %	2	2	2	2	2	2	2	2	2	2	2	2
Mvmt Flow	46	1090	7	41	1539	38	9	0	40	14	1	37

Major/Minor	Major1		Major2		Minor1		Minor2					
Conflicting Flow All	1577	0	0	1097	0	0	2034	2841	545	2258	2810	770
Stage 1	-	-	-	-	-	-	1182	1182	-	1621	1621	-
Stage 2	-	-	-	-	-	-	852	1659	-	637	1189	-
Critical Hdwy	4.14	-	-	4.14	-	-	7.54	6.54	6.94	7.54	6.54	6.94
Critical Hdwy Stg 1	-	-	-	-	-	-	6.54	5.54	-	6.54	5.54	-
Critical Hdwy Stg 2	-	-	-	-	-	-	6.54	5.54	-	6.54	5.54	-
Follow-up Hdwy	2.22	-	-	2.22	-	-	3.52	4.02	3.32	3.52	4.02	3.32
Pot Cap-1 Maneuver	414	-	-	*985	-	-	60	12	*659	*32	13	343
Stage 1	-	-	-	-	-	-	613	539	-	*107	160	-
Stage 2	-	-	-	-	-	-	321	153	-	*621	533	-
Platoon blocked, %		-	-	1	-	-	1	1	1	1	1	
Mov Cap-1 Maneuver	414	-	-	*985	-	-	47	10	*659	*26	11	343
Mov Cap-2 Maneuver	-	-	-	-	-	-	200	93	-	*89	135	-
Stage 1	-	-	-	-	-	-	545	479	-	*95	153	-
Stage 2	-	-	-	-	-	-	273	147	-	*518	474	-

Approach	EB		WB		NB		SB	
HCM Control Delay, s	0.6		0.2		13.1		27.2	
HCM LOS					B		D	

Minor Lane/Major Mvmt	NBLn1	NBLn2	EBL	EBT	EBR	WBL	WBT	WBR	SBLn1	SBLn2
Capacity (veh/h)	200	659	414	-	-	*985	-	-	91	343
HCM Lane V/C Ratio	0.043	0.061	0.11	-	-	0.042	-	-	0.167	0.108
HCM Control Delay (s)	23.8	10.8	14.8	-	-	8.8	-	-	52.3	16.8
HCM Lane LOS	C	B	B	-	-	A	-	-	F	C
HCM 95th %tile Q(veh)	0.1	0.2	0.4	-	-	0.1	-	-	0.6	0.4

Notes
 -: Volume exceeds capacity \$: Delay exceeds 300s +: Computation Not Defined *: All major volume in platoon

Intersection												
Int Delay, s/veh	1.4											
Movement	EBL	EBT	EBR	WBL	WBT	WBR	NBL	NBT	NBR	SBL	SBT	SBR
Lane Configurations	↘	↑↑	↗	↘	↑↑	↗		↘	↗		↘	↗
Traffic Vol, veh/h	46	1269	15	82	1277	17	2	1	38	20	3	48
Future Vol, veh/h	46	1269	15	82	1277	17	2	1	38	20	3	48
Conflicting Peds, #/hr	0	0	0	0	0	0	0	0	0	0	0	0
Sign Control	Free	Free	Free	Free	Free	Free	Stop	Stop	Stop	Stop	Stop	Stop
RT Channelized	-	-	None	-	-	None	-	-	None	-	-	None
Storage Length	175	-	125	225	-	150	-	-	75	-	-	75
Veh in Median Storage, #	-	0	-	-	0	-	-	2	-	-	2	-
Grade, %	-	0	-	-	0	-	-	0	-	-	0	-
Peak Hour Factor	93	93	93	93	93	93	93	93	93	93	93	93
Heavy Vehicles, %	2	2	2	2	2	2	2	2	2	2	2	2
Mvmt Flow	49	1365	16	88	1373	18	2	1	41	22	3	52

Major/Minor	Major1			Major2			Minor1			Minor2		
Conflicting Flow All	1391	0	0	1381	0	0	2327	3030	683	2330	3028	687
Stage 1	-	-	-	-	-	-	1463	1463	-	1549	1549	-
Stage 2	-	-	-	-	-	-	864	1567	-	781	1479	-
Critical Hdwy	4.14	-	-	4.14	-	-	7.54	6.54	6.94	7.54	6.54	6.94
Critical Hdwy Stg 1	-	-	-	-	-	-	6.54	5.54	-	6.54	5.54	-
Critical Hdwy Stg 2	-	-	-	-	-	-	6.54	5.54	-	6.54	5.54	-
Follow-up Hdwy	2.22	-	-	2.22	-	-	3.52	4.02	3.32	3.52	4.02	3.32
Pot Cap-1 Maneuver	488	-	-	*829	-	-	*31	*6	*554	*31	6	389
Stage 1	-	-	-	-	-	-	*523	*458	-	*119	174	-
Stage 2	-	-	-	-	-	-	*315	*170	-	*523	445	-
Platoon blocked, %		-	-	1	-	-	1	1	1	1	1	
Mov Cap-1 Maneuver	488	-	-	*829	-	-	*23	*5	*554	*24	5	389
Mov Cap-2 Maneuver	-	-	-	-	-	-	*166	*94	-	*98	128	-
Stage 1	-	-	-	-	-	-	*470	*412	-	*107	156	-
Stage 2	-	-	-	-	-	-	*239	*152	-	*434	401	-

Approach	EB	WB	NB	SB
HCM Control Delay, s	0.5	0.6	13.5	27.4
HCM LOS			B	D

Minor Lane/Major Mvmt	NBLn1	NBLn2	EBL	EBT	EBR	WBL	WBT	WBR	SBLn1	SBLn2
Capacity (veh/h)	132	554	488	-	-	*829	-	-	101	389
HCM Lane V/C Ratio	0.024	0.074	0.101	-	-	0.106	-	-	0.245	0.133
HCM Control Delay (s)	33	12	13.2	-	-	9.9	-	-	51.8	15.7
HCM Lane LOS	D	B	B	-	-	A	-	-	F	C
HCM 95th %tile Q(veh)	0.1	0.2	0.3	-	-	0.4	-	-	0.9	0.5

Notes
 -: Volume exceeds capacity \$: Delay exceeds 300s +: Computation Not Defined *: All major volume in platoon

Timings
3: Voyager Pkwy & Spectrum Loop

2022 Existing AM
08/25/2022

Lane Group	EBL	EBT	EBR	WBL	WBT	WBR	NBL	NBT	NBR	SBL	SBT	SBR
Lane Configurations												
Traffic Volume (vph)	17	6	58	103	10	19	69	319	58	7	535	32
Future Volume (vph)	17	6	58	103	10	19	69	319	58	7	535	32
Turn Type	Perm	NA	Perm	Perm	NA	Perm	Prot	NA	Perm	Prot	NA	Perm
Protected Phases		4			8		5	2		1	6	
Permitted Phases	4		4	8		8			2			6
Detector Phase	4	4	4	8	8	8	5	2	2	1	6	6
Switch Phase												
Minimum Initial (s)	4.0	4.0	4.0	4.0	4.0	4.0	4.0	23.0	23.0	4.0	23.0	23.0
Minimum Split (s)	24.5	24.5	24.5	24.5	24.5	24.5	9.0	29.5	29.5	9.0	29.5	29.5
Total Split (s)	37.0	37.0	37.0	37.0	37.0	37.0	16.0	85.0	85.0	16.0	85.0	85.0
Total Split (%)	26.8%	26.8%	26.8%	26.8%	26.8%	26.8%	11.6%	61.6%	61.6%	11.6%	61.6%	61.6%
Yellow Time (s)	4.5	4.5	4.5	4.5	4.5	4.5	3.0	4.5	4.5	3.0	4.5	4.5
All-Red Time (s)	2.0	2.0	2.0	2.0	2.0	2.0	2.0	2.0	2.0	2.0	2.0	2.0
Lost Time Adjust (s)	0.0	0.0	0.0	0.0	0.0	0.0	0.0	0.0	0.0	0.0	0.0	0.0
Total Lost Time (s)	6.5	6.5	6.5	6.5	6.5	6.5	5.0	6.5	6.5	5.0	6.5	6.5
Lead/Lag							Lead	Lag	Lag	Lead	Lag	Lag
Lead-Lag Optimize?							Yes	Yes	Yes	Yes	Yes	Yes
Recall Mode	None	None	None	None	None	None	None	C-Max	C-Max	None	C-Max	C-Max
Act Effct Green (s)	16.5	16.5	16.5	16.5	16.5	16.5	11.3	106.0	106.0	6.3	92.2	92.2
Actuated g/C Ratio	0.12	0.12	0.12	0.12	0.12	0.12	0.08	0.77	0.77	0.05	0.67	0.67
v/c Ratio	0.11	0.03	0.26	0.68	0.05	0.08	0.53	0.13	0.05	0.10	0.25	0.03
Control Delay	52.9	50.3	12.9	77.3	50.9	0.7	75.5	5.9	3.1	65.4	10.4	0.6
Queue Delay	0.0	0.0	0.0	0.0	0.0	0.0	0.0	0.0	0.0	0.0	0.0	0.0
Total Delay	52.9	50.3	12.9	77.3	50.9	0.7	75.5	5.9	3.1	65.4	10.4	0.6
LOS	D	D	B	E	D	A	E	A	A	E	B	A
Approach Delay		24.3			64.3			16.3			10.5	
Approach LOS		C			E			B			B	

Intersection Summary

Cycle Length: 138
 Actuated Cycle Length: 138
 Offset: 75 (54%), Referenced to phase 2:NBT and 6:SBT, Start of Green
 Natural Cycle: 65
 Control Type: Actuated-Coordinated
 Maximum v/c Ratio: 0.68
 Intersection Signal Delay: 19.3
 Intersection Capacity Utilization 50.4%
 Analysis Period (min) 15

Intersection LOS: B
 ICU Level of Service A

Splits and Phases: 3: Voyager Pkwy & Spectrum Loop

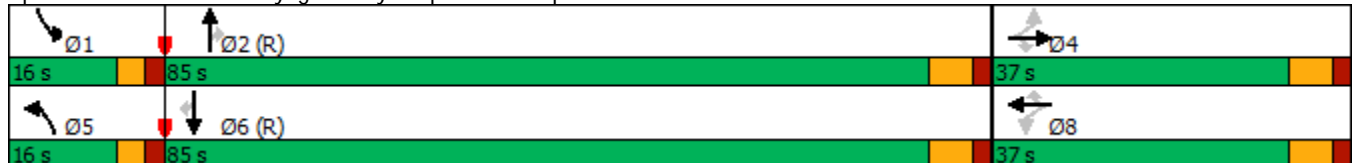

HCM 6th Signalized Intersection Summary
 3: Voyager Pkwy & Spectrum Loop

2022 Existing AM
 08/25/2022

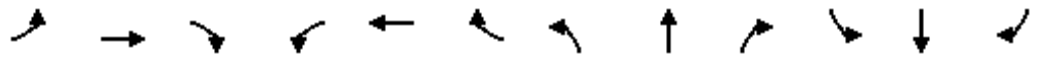

Movement	EBL	EBT	EBR	WBL	WBT	WBR	NBL	NBT	NBR	SBL	SBT	SBR
Lane Configurations												
Traffic Volume (veh/h)	17	6	58	103	10	19	69	319	58	7	535	32
Future Volume (veh/h)	17	6	58	103	10	19	69	319	58	7	535	32
Initial Q (Qb), veh	0	0	0	0	0	0	0	0	0	0	0	0
Ped-Bike Adj(A_pbT)	1.00		1.00	1.00		1.00	1.00		1.00	1.00		1.00
Parking Bus, Adj	1.00	1.00	1.00	1.00	1.00	1.00	1.00	1.00	1.00	1.00	1.00	1.00
Work Zone On Approach		No			No			No			No	
Adj Sat Flow, veh/h/ln	1870	1870	1870	1870	1870	1870	1870	1870	1870	1870	1870	1870
Adj Flow Rate, veh/h	19	7	64	114	11	21	77	354	64	8	594	36
Peak Hour Factor	0.90	0.90	0.90	0.90	0.90	0.90	0.90	0.90	0.90	0.90	0.90	0.90
Percent Heavy Veh, %	2	2	2	2	2	2	2	2	2	2	2	2
Cap, veh/h	189	196	166	187	196	166	96	2691	1200	14	2526	1127
Arrive On Green	0.10	0.10	0.10	0.10	0.10	0.10	0.11	1.00	1.00	0.01	0.71	0.71
Sat Flow, veh/h	1377	1870	1585	1329	1870	1585	1781	3554	1585	1781	3554	1585
Grp Volume(v), veh/h	19	7	64	114	11	21	77	354	64	8	594	36
Grp Sat Flow(s),veh/h/ln	1377	1870	1585	1329	1870	1585	1781	1777	1585	1781	1777	1585
Q Serve(g_s), s	1.7	0.5	5.2	11.6	0.7	1.7	5.8	0.0	0.0	0.6	8.0	0.9
Cycle Q Clear(g_c), s	2.5	0.5	5.2	12.1	0.7	1.7	5.8	0.0	0.0	0.6	8.0	0.9
Prop In Lane	1.00		1.00	1.00		1.00	1.00		1.00	1.00		1.00
Lane Grp Cap(c), veh/h	189	196	166	187	196	166	96	2691	1200	14	2526	1127
V/C Ratio(X)	0.10	0.04	0.39	0.61	0.06	0.13	0.80	0.13	0.05	0.59	0.24	0.03
Avail Cap(c_a), veh/h	349	413	350	342	413	350	142	2691	1200	142	2526	1127
HCM Platoon Ratio	1.00	1.00	1.00	1.00	1.00	1.00	2.00	2.00	2.00	1.00	1.00	1.00
Upstream Filter(l)	1.00	1.00	1.00	1.00	1.00	1.00	0.99	0.99	0.99	0.93	0.93	0.93
Uniform Delay (d), s/veh	56.7	55.5	57.6	60.9	55.6	56.0	60.8	0.0	0.0	68.3	6.9	5.9
Incr Delay (d2), s/veh	0.2	0.1	1.5	3.2	0.1	0.3	17.6	0.1	0.1	32.1	0.2	0.0
Initial Q Delay(d3),s/veh	0.0	0.0	0.0	0.0	0.0	0.0	0.0	0.0	0.0	0.0	0.0	0.0
%ile BackOfQ(50%),veh/ln	0.6	0.2	2.2	4.1	0.4	0.7	3.0	0.0	0.0	0.4	3.0	0.3
Unsig. Movement Delay, s/veh												
LnGrp Delay(d),s/veh	57.0	55.6	59.1	64.1	55.7	56.4	78.4	0.1	0.1	100.4	7.1	6.0
LnGrp LOS	E	E	E	E	E	E	E	A	A	F	A	A
Approach Vol, veh/h		90			146			495			638	
Approach Delay, s/veh		58.4			62.4			12.3			8.2	
Approach LOS		E			E			B			A	
Timer - Assigned Phs	1	2		4	5	6		8				
Phs Duration (G+Y+Rc), s	6.1	111.0		21.0	12.5	104.6		21.0				
Change Period (Y+Rc), s	5.0	6.5		6.5	5.0	6.5		6.5				
Max Green Setting (Gmax), s	11.0	78.5		30.5	11.0	78.5		30.5				
Max Q Clear Time (g_c+I1), s	2.6	2.0		7.2	7.8	10.0		14.1				
Green Ext Time (p_c), s	0.0	2.8		0.2	0.0	4.9		0.4				
Intersection Summary												
HCM 6th Ctrl Delay				18.8								
HCM 6th LOS				B								

Timings
3: Voyager Pkwy & Spectrum Loop

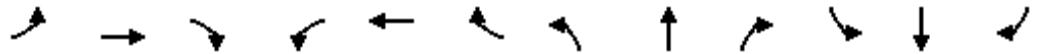

Lane Group	EBL	EBT	EBR	WBL	WBT	WBR	NBL	NBT	NBR	SBL	SBT	SBR
Lane Configurations	↖	↗	↘	↖	↗	↘	↖	↕	↗	↖	↕	↘
Traffic Volume (vph)	66	35	162	167	30	60	191	361	201	34	332	51
Future Volume (vph)	66	35	162	167	30	60	191	361	201	34	332	51
Turn Type	Perm	NA	Perm	Perm	NA	Perm	Prot	NA	Perm	Prot	NA	Perm
Protected Phases		4			8		5	2		1	6	
Permitted Phases	4		4	8		8			2			6
Detector Phase	4	4	4	8	8	8	5	2	2	1	6	6
Switch Phase												
Minimum Initial (s)	4.0	4.0	4.0	4.0	4.0	4.0	4.0	23.0	23.0	4.0	23.0	23.0
Minimum Split (s)	24.5	24.5	24.5	24.5	24.5	24.5	9.0	29.5	29.5	9.0	29.5	29.5
Total Split (s)	37.0	37.0	37.0	37.0	37.0	37.0	16.0	85.0	85.0	16.0	85.0	85.0
Total Split (%)	26.8%	26.8%	26.8%	26.8%	26.8%	26.8%	11.6%	61.6%	61.6%	11.6%	61.6%	61.6%
Yellow Time (s)	4.5	4.5	4.5	4.5	4.5	4.5	3.0	4.5	4.5	3.0	4.5	4.5
All-Red Time (s)	2.0	2.0	2.0	2.0	2.0	2.0	2.0	2.0	2.0	2.0	2.0	2.0
Lost Time Adjust (s)	0.0	0.0	0.0	0.0	0.0	0.0	0.0	0.0	0.0	0.0	0.0	0.0
Total Lost Time (s)	6.5	6.5	6.5	6.5	6.5	6.5	5.0	6.5	6.5	5.0	6.5	6.5
Lead/Lag							Lead	Lag	Lag	Lead	Lag	Lag
Lead-Lag Optimize?							Yes	Yes	Yes	Yes	Yes	Yes
Recall Mode	None	None	None	None	None	None	None	C-Max	C-Max	None	C-Max	C-Max
Act Effct Green (s)	23.7	23.7	23.7	23.7	23.7	23.7	17.8	90.1	90.1	8.3	78.5	78.5
Actuated g/C Ratio	0.17	0.17	0.17	0.17	0.17	0.17	0.13	0.65	0.65	0.06	0.57	0.57
v/c Ratio	0.32	0.12	0.43	0.81	0.11	0.21	0.94	0.18	0.20	0.36	0.19	0.06
Control Delay	51.9	46.6	9.3	79.1	46.2	11.3	104.8	11.0	2.0	70.8	14.6	2.4
Queue Delay	0.0	0.0	0.0	0.0	0.0	0.0	0.0	0.0	0.0	0.0	0.0	0.0
Total Delay	51.9	46.6	9.3	79.1	46.2	11.3	104.8	11.0	2.0	70.8	14.6	2.4
LOS	D	D	A	E	D	B	F	B	A	E	B	A
Approach Delay		24.9			59.5			32.4			17.7	
Approach LOS		C			E			C			B	

Intersection Summary

Cycle Length: 138
 Actuated Cycle Length: 138
 Offset: 75 (54%), Referenced to phase 2:NBT and 6:SBT, Start of Green
 Natural Cycle: 65
 Control Type: Actuated-Coordinated
 Maximum v/c Ratio: 0.94
 Intersection Signal Delay: 31.8 Intersection LOS: C
 Intersection Capacity Utilization 60.7% ICU Level of Service B
 Analysis Period (min) 15

Splits and Phases: 3: Voyager Pkwy & Spectrum Loop

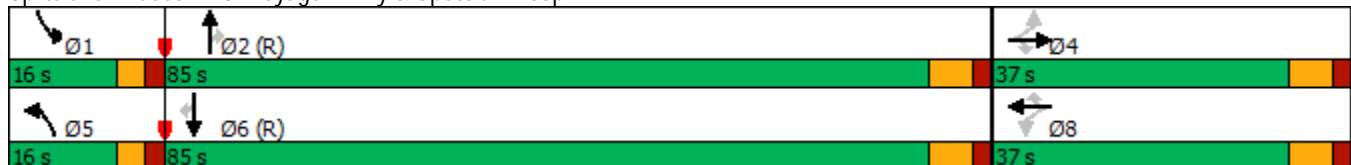

HCM 6th Signalized Intersection Summary
 3: Voyager Pkwy & Spectrum Loop

2022 Existing PM
 08/29/2022



Movement	EBL	EBT	EBR	WBL	WBT	WBR	NBL	NBT	NBR	SBL	SBT	SBR
Lane Configurations												
Traffic Volume (veh/h)	66	35	162	167	30	60	191	361	201	34	332	51
Future Volume (veh/h)	66	35	162	167	30	60	191	361	201	34	332	51
Initial Q (Qb), veh	0	0	0	0	0	0	0	0	0	0	0	0
Ped-Bike Adj(A_pbT)	1.00		1.00	1.00		1.00	1.00		1.00	1.00		1.00
Parking Bus, Adj	1.00	1.00	1.00	1.00	1.00	1.00	1.00	1.00	1.00	1.00	1.00	1.00
Work Zone On Approach		No			No			No			No	
Adj Sat Flow, veh/h/ln	1870	1870	1870	1870	1870	1870	1870	1870	1870	1870	1870	1870
Adj Flow Rate, veh/h	74	39	182	188	34	67	215	406	226	38	373	57
Peak Hour Factor	0.89	0.89	0.89	0.89	0.89	0.89	0.89	0.89	0.89	0.89	0.89	0.89
Percent Heavy Veh, %	2	2	2	2	2	2	2	2	2	2	2	2
Cap, veh/h	284	363	307	257	363	307	142	2303	1027	49	2118	945
Arrive On Green	0.19	0.19	0.19	0.19	0.19	0.19	0.13	1.00	1.00	0.03	0.60	0.60
Sat Flow, veh/h	1294	1870	1585	1160	1870	1585	1781	3554	1585	1781	3554	1585
Grp Volume(v), veh/h	74	39	182	188	34	67	215	406	226	38	373	57
Grp Sat Flow(s),veh/h/ln	1294	1870	1585	1160	1870	1585	1781	1777	1585	1781	1777	1585
Q Serve(g_s), s	6.9	2.4	14.4	22.0	2.1	4.9	11.0	0.0	0.0	2.9	6.5	2.1
Cycle Q Clear(g_c), s	8.9	2.4	14.4	24.3	2.1	4.9	11.0	0.0	0.0	2.9	6.5	2.1
Prop In Lane	1.00		1.00	1.00		1.00	1.00		1.00	1.00		1.00
Lane Grp Cap(c), veh/h	284	363	307	257	363	307	142	2303	1027	49	2118	945
V/C Ratio(X)	0.26	0.11	0.59	0.73	0.09	0.22	1.51	0.18	0.22	0.78	0.18	0.06
Avail Cap(c_a), veh/h	319	413	350	289	413	350	142	2303	1027	142	2118	945
HCM Platoon Ratio	1.00	1.00	1.00	1.00	1.00	1.00	1.67	1.67	1.67	1.00	1.00	1.00
Upstream Filter(l)	1.00	1.00	1.00	1.00	1.00	1.00	1.00	1.00	1.00	0.95	0.95	0.95
Uniform Delay (d), s/veh	49.3	45.8	50.6	55.8	45.7	46.8	59.8	0.0	0.0	66.7	12.6	11.7
Incr Delay (d2), s/veh	0.5	0.1	2.1	8.1	0.1	0.4	264.1	0.2	0.5	21.5	0.2	0.1
Initial Q Delay(d3),s/veh	0.0	0.0	0.0	0.0	0.0	0.0	0.0	0.0	0.0	0.0	0.0	0.0
%ile BackOfQ(50%),veh/ln	2.3	1.1	5.9	7.0	1.0	2.0	15.1	0.1	0.1	1.6	2.7	0.8
Unsig. Movement Delay, s/veh												
LnGrp Delay(d),s/veh	49.8	45.9	52.7	63.9	45.8	47.2	323.9	0.2	0.5	88.2	12.8	11.8
LnGrp LOS	D	D	D	E	D	D	F	A	A	F	B	B
Approach Vol, veh/h		295			289			847			468	
Approach Delay, s/veh		51.1			57.9			82.4			18.8	
Approach LOS		D			E			F			B	
Timer - Assigned Phs	1	2		4	5	6		8				
Phs Duration (G+Y+Rc), s	8.8	95.9		33.3	16.0	88.7		33.3				
Change Period (Y+Rc), s	5.0	6.5		6.5	5.0	6.5		6.5				
Max Green Setting (Gmax), s	11.0	78.5		30.5	11.0	78.5		30.5				
Max Q Clear Time (g_c+I1), s	4.9	2.0		16.4	13.0	8.5		26.3				
Green Ext Time (p_c), s	0.0	3.9		0.9	0.0	3.0		0.4				
Intersection Summary												
HCM 6th Ctrl Delay			58.1									
HCM 6th LOS			E									

Timings
3: Voyager Pkwy & Spectrum Loop

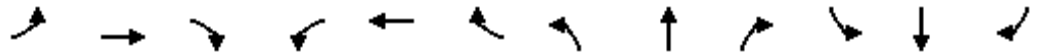

Lane Group	EBL	EBT	EBR	WBL	WBT	WBR	NBL	NBT	NBR	SBL	SBT	SBR
Lane Configurations	↖	↗	↖	↖	↗	↖	↖	↕	↖	↖	↕	↖
Traffic Volume (vph)	60	6	71	104	10	19	75	342	59	7	567	51
Future Volume (vph)	60	6	71	104	10	19	75	342	59	7	567	51
Turn Type	Perm	NA	Perm	Perm	NA	Perm	Prot	NA	Perm	Prot	NA	Perm
Protected Phases		4			8		5	2		1	6	
Permitted Phases	4		4	8		8			2			6
Detector Phase	4	4	4	8	8	8	5	2	2	1	6	6
Switch Phase												
Minimum Initial (s)	4.0	4.0	4.0	4.0	4.0	4.0	4.0	23.0	23.0	4.0	23.0	23.0
Minimum Split (s)	24.5	24.5	24.5	24.5	24.5	24.5	9.0	29.5	29.5	9.0	29.5	29.5
Total Split (s)	37.0	37.0	37.0	37.0	37.0	37.0	16.0	85.0	85.0	16.0	85.0	85.0
Total Split (%)	26.8%	26.8%	26.8%	26.8%	26.8%	26.8%	11.6%	61.6%	61.6%	11.6%	61.6%	61.6%
Yellow Time (s)	4.5	4.5	4.5	4.5	4.5	4.5	3.0	4.5	4.5	3.0	4.5	4.5
All-Red Time (s)	2.0	2.0	2.0	2.0	2.0	2.0	2.0	2.0	2.0	2.0	2.0	2.0
Lost Time Adjust (s)	0.0	0.0	0.0	0.0	0.0	0.0	0.0	0.0	0.0	0.0	0.0	0.0
Total Lost Time (s)	6.5	6.5	6.5	6.5	6.5	6.5	5.0	6.5	6.5	5.0	6.5	6.5
Lead/Lag							Lead	Lag	Lag	Lead	Lag	Lag
Lead-Lag Optimize?							Yes	Yes	Yes	Yes	Yes	Yes
Recall Mode	None	None	None	None	None	None	None	C-Max	C-Max	None	C-Max	C-Max
Act Effct Green (s)	16.7	16.7	16.7	16.7	16.7	16.7	11.8	105.8	105.8	6.3	91.5	91.5
Actuated g/C Ratio	0.12	0.12	0.12	0.12	0.12	0.12	0.09	0.77	0.77	0.05	0.66	0.66
v/c Ratio	0.40	0.03	0.30	0.69	0.05	0.08	0.55	0.14	0.05	0.10	0.27	0.05
Control Delay	61.3	50.0	13.3	77.3	50.7	0.7	75.4	6.5	3.9	65.4	10.9	2.1
Queue Delay	0.0	0.0	0.0	0.0	0.0	0.0	0.0	0.0	0.0	0.0	0.0	0.0
Total Delay	61.3	50.0	13.3	77.3	50.7	0.7	75.4	6.5	3.9	65.4	10.9	2.1
LOS	E	D	B	E	D	A	E	A	A	E	B	A
Approach Delay		36.0			64.5			17.0			10.8	
Approach LOS		D			E			B			B	

Intersection Summary

Cycle Length: 138
 Actuated Cycle Length: 138
 Offset: 75 (54%), Referenced to phase 2:NBT and 6:SBT, Start of Green
 Natural Cycle: 65
 Control Type: Actuated-Coordinated
 Maximum v/c Ratio: 0.69
 Intersection Signal Delay: 20.7
 Intersection Capacity Utilization 50.8%
 Analysis Period (min) 15

Intersection LOS: C
 ICU Level of Service A

Splits and Phases: 3: Voyager Pkwy & Spectrum Loop



HCM 6th Signalized Intersection Summary
 3: Voyager Pkwy & Spectrum Loop

2024 Background AM

08/29/2022

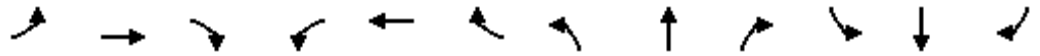

Movement	EBL	EBT	EBR	WBL	WBT	WBR	NBL	NBT	NBR	SBL	SBT	SBR
Lane Configurations	↖	↑	↗	↖	↑	↗	↖	↑↑	↗	↖	↑↑	↗
Traffic Volume (veh/h)	60	6	71	104	10	19	75	342	59	7	567	51
Future Volume (veh/h)	60	6	71	104	10	19	75	342	59	7	567	51
Initial Q (Qb), veh	0	0	0	0	0	0	0	0	0	0	0	0
Ped-Bike Adj(A_pbT)	1.00		1.00	1.00		1.00	1.00		1.00	1.00		1.00
Parking Bus, Adj	1.00	1.00	1.00	1.00	1.00	1.00	1.00	1.00	1.00	1.00	1.00	1.00
Work Zone On Approach		No			No			No			No	
Adj Sat Flow, veh/h/ln	1870	1870	1870	1870	1870	1870	1870	1870	1870	1870	1870	1870
Adj Flow Rate, veh/h	67	7	79	116	11	21	83	380	66	8	630	57
Peak Hour Factor	0.90	0.90	0.90	0.90	0.90	0.90	0.90	0.90	0.90	0.90	0.90	0.90
Percent Heavy Veh, %	2	2	2	2	2	2	2	2	2	2	2	2
Cap, veh/h	193	201	170	189	201	170	103	2681	1196	14	2503	1116
Arrive On Green	0.11	0.11	0.11	0.11	0.11	0.11	0.12	1.00	1.00	0.01	0.70	0.70
Sat Flow, veh/h	1377	1870	1585	1311	1870	1585	1781	3554	1585	1781	3554	1585
Grp Volume(v), veh/h	67	7	79	116	11	21	83	380	66	8	630	57
Grp Sat Flow(s),veh/h/ln	1377	1870	1585	1311	1870	1585	1781	1777	1585	1781	1777	1585
Q Serve(g_s), s	6.3	0.5	6.5	12.0	0.7	1.7	6.3	0.0	0.0	0.6	8.8	1.5
Cycle Q Clear(g_c), s	7.1	0.5	6.5	12.5	0.7	1.7	6.3	0.0	0.0	0.6	8.8	1.5
Prop In Lane	1.00		1.00	1.00		1.00	1.00		1.00	1.00		1.00
Lane Grp Cap(c), veh/h	193	201	170	189	201	170	103	2681	1196	14	2503	1116
V/C Ratio(X)	0.35	0.03	0.46	0.61	0.05	0.12	0.81	0.14	0.06	0.59	0.25	0.05
Avail Cap(c_a), veh/h	349	413	350	338	413	350	142	2681	1196	142	2503	1116
HCM Platoon Ratio	1.00	1.00	1.00	1.00	1.00	1.00	2.00	2.00	2.00	1.00	1.00	1.00
Upstream Filter(l)	1.00	1.00	1.00	1.00	1.00	1.00	0.99	0.99	0.99	0.91	0.91	0.91
Uniform Delay (d), s/veh	58.5	55.2	57.8	60.8	55.3	55.7	60.3	0.0	0.0	68.3	7.3	6.3
Incr Delay (d2), s/veh	1.1	0.1	2.0	3.2	0.1	0.3	20.5	0.1	0.1	31.5	0.2	0.1
Initial Q Delay(d3),s/veh	0.0	0.0	0.0	0.0	0.0	0.0	0.0	0.0	0.0	0.0	0.0	0.0
%ile BackOfQ(50%),veh/ln	2.3	0.2	2.7	4.2	0.4	0.7	3.3	0.0	0.0	0.4	3.3	0.5
Unsig. Movement Delay, s/veh												
LnGrp Delay(d),s/veh	59.5	55.2	59.8	64.0	55.4	56.0	80.8	0.1	0.1	99.8	7.5	6.3
LnGrp LOS	E	E	E	E	E	E	F	A	A	F	A	A
Approach Vol, veh/h		153			148			529			695	
Approach Delay, s/veh		59.5			62.2			12.8			8.5	
Approach LOS		E			E			B			A	
Timer - Assigned Phs	1	2		4	5	6		8				
Phs Duration (G+Y+Rc), s	6.1	110.6		21.3	13.0	103.7		21.3				
Change Period (Y+Rc), s	5.0	6.5		6.5	5.0	6.5		6.5				
Max Green Setting (Gmax), s	11.0	78.5		30.5	11.0	78.5		30.5				
Max Q Clear Time (g_c+I1), s	2.6	2.0		9.1	8.3	10.8		14.5				
Green Ext Time (p_c), s	0.0	3.0		0.4	0.0	5.3		0.4				

Intersection Summary

HCM 6th Ctrl Delay	20.3
HCM 6th LOS	C

Timings
3: Voyager Pkwy & Spectrum Loop

Lane Group	EBL	EBT	EBR	WBL	WBT	WBR	NBL	NBT	NBR	SBL	SBT	SBR
Lane Configurations												
Traffic Volume (vph)	103	35	178	169	30	61	208	385	203	34	356	98
Future Volume (vph)	103	35	178	169	30	61	208	385	203	34	356	98
Turn Type	Perm	NA	Perm	Perm	NA	Perm	Prot	NA	Perm	Prot	NA	Perm
Protected Phases		4			8		5	2		1	6	
Permitted Phases	4		4	8		8			2			6
Detector Phase	4	4	4	8	8	8	5	2	2	1	6	6
Switch Phase												
Minimum Initial (s)	4.0	4.0	4.0	4.0	4.0	4.0	4.0	23.0	23.0	4.0	23.0	23.0
Minimum Split (s)	24.5	24.5	24.5	24.5	24.5	24.5	9.0	29.5	29.5	9.0	29.5	29.5
Total Split (s)	37.0	37.0	37.0	37.0	37.0	37.0	16.0	85.0	85.0	16.0	85.0	85.0
Total Split (%)	26.8%	26.8%	26.8%	26.8%	26.8%	26.8%	11.6%	61.6%	61.6%	11.6%	61.6%	61.6%
Yellow Time (s)	4.5	4.5	4.5	4.5	4.5	4.5	3.0	4.5	4.5	3.0	4.5	4.5
All-Red Time (s)	2.0	2.0	2.0	2.0	2.0	2.0	2.0	2.0	2.0	2.0	2.0	2.0
Lost Time Adjust (s)	0.0	0.0	0.0	0.0	0.0	0.0	0.0	0.0	0.0	0.0	0.0	0.0
Total Lost Time (s)	6.5	6.5	6.5	6.5	6.5	6.5	5.0	6.5	6.5	5.0	6.5	6.5
Lead/Lag							Lead	Lag	Lag	Lead	Lag	Lag
Lead-Lag Optimize?							Yes	Yes	Yes	Yes	Yes	Yes
Recall Mode	None	None	None	None	None	None	None	C-Max	C-Max	None	C-Max	C-Max
Act Effct Green (s)	23.8	23.8	23.8	23.8	23.8	23.8	17.7	90.0	90.0	8.3	78.5	78.5
Actuated g/C Ratio	0.17	0.17	0.17	0.17	0.17	0.17	0.13	0.65	0.65	0.06	0.57	0.57
v/c Ratio	0.49	0.12	0.46	0.81	0.11	0.21	1.04	0.19	0.21	0.36	0.20	0.12
Control Delay	57.6	46.5	9.3	79.2	46.1	11.1	125.7	11.2	2.0	70.8	14.8	2.6
Queue Delay	0.0	0.0	0.0	0.0	0.0	0.0	0.0	0.0	0.0	0.0	0.0	0.0
Total Delay	57.6	46.5	9.3	79.2	46.1	11.1	125.7	11.2	2.0	70.8	14.8	2.6
LOS	E	D	A	E	D	B	F	B	A	E	B	A
Approach Delay		29.2			59.3			38.8			16.2	
Approach LOS		C			E			D			B	

Intersection Summary

Cycle Length: 138
 Actuated Cycle Length: 138
 Offset: 75 (54%), Referenced to phase 2:NBT and 6:SBT, Start of Green
 Natural Cycle: 70
 Control Type: Actuated-Coordinated
 Maximum v/c Ratio: 1.04
 Intersection Signal Delay: 34.1
 Intersection LOS: C
 Intersection Capacity Utilization 61.7%
 ICU Level of Service B
 Analysis Period (min) 15

Splits and Phases: 3: Voyager Pkwy & Spectrum Loop



HCM 6th Signalized Intersection Summary
 3: Voyager Pkwy & Spectrum Loop

2024 Background PM

08/29/2022

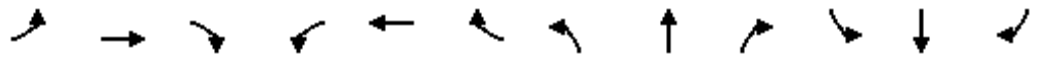

Movement	EBL	EBT	EBR	WBL	WBT	WBR	NBL	NBT	NBR	SBL	SBT	SBR
Lane Configurations	↖	↑	↗	↖	↑	↗	↖	↑↑	↗	↖	↑↑	↗
Traffic Volume (veh/h)	103	35	178	169	30	61	208	385	203	34	356	98
Future Volume (veh/h)	103	35	178	169	30	61	208	385	203	34	356	98
Initial Q (Qb), veh	0	0	0	0	0	0	0	0	0	0	0	0
Ped-Bike Adj(A_pbT)	1.00		1.00	1.00		1.00	1.00		1.00	1.00		1.00
Parking Bus, Adj	1.00	1.00	1.00	1.00	1.00	1.00	1.00	1.00	1.00	1.00	1.00	1.00
Work Zone On Approach		No			No			No			No	
Adj Sat Flow, veh/h/ln	1870	1870	1870	1870	1870	1870	1870	1870	1870	1870	1870	1870
Adj Flow Rate, veh/h	116	39	200	190	34	69	234	433	228	38	400	110
Peak Hour Factor	0.89	0.89	0.89	0.89	0.89	0.89	0.89	0.89	0.89	0.89	0.89	0.89
Percent Heavy Veh, %	2	2	2	2	2	2	2	2	2	2	2	2
Cap, veh/h	289	370	314	259	370	314	142	2289	1021	49	2103	938
Arrive On Green	0.20	0.20	0.20	0.20	0.20	0.20	0.13	1.00	1.00	0.03	0.59	0.59
Sat Flow, veh/h	1291	1870	1585	1141	1870	1585	1781	3554	1585	1781	3554	1585
Grp Volume(v), veh/h	116	39	200	190	34	69	234	433	228	38	400	110
Grp Sat Flow(s),veh/h/ln	1291	1870	1585	1141	1870	1585	1781	1777	1585	1781	1777	1585
Q Serve(g_s), s	11.1	2.4	16.0	22.6	2.0	5.0	11.0	0.0	0.0	2.9	7.1	4.2
Cycle Q Clear(g_c), s	13.2	2.4	16.0	24.9	2.0	5.0	11.0	0.0	0.0	2.9	7.1	4.2
Prop In Lane	1.00		1.00	1.00		1.00	1.00		1.00	1.00		1.00
Lane Grp Cap(c), veh/h	289	370	314	259	370	314	142	2289	1021	49	2103	938
V/C Ratio(X)	0.40	0.11	0.64	0.73	0.09	0.22	1.65	0.19	0.22	0.78	0.19	0.12
Avail Cap(c_a), veh/h	318	413	350	285	413	350	142	2289	1021	142	2103	938
HCM Platoon Ratio	1.00	1.00	1.00	1.00	1.00	1.00	1.67	1.67	1.67	1.00	1.00	1.00
Upstream Filter(I)	1.00	1.00	1.00	1.00	1.00	1.00	1.00	1.00	1.00	0.91	0.91	0.91
Uniform Delay (d), s/veh	50.6	45.3	50.8	55.5	45.2	46.4	59.8	0.0	0.0	66.7	13.0	12.4
Incr Delay (d2), s/veh	0.9	0.1	3.2	8.6	0.1	0.3	320.9	0.2	0.5	20.8	0.2	0.2
Initial Q Delay(d3),s/veh	0.0	0.0	0.0	0.0	0.0	0.0	0.0	0.0	0.0	0.0	0.0	0.0
%ile BackOfQ(50%),veh/ln	3.7	1.1	6.7	7.1	1.0	2.0	17.3	0.1	0.1	1.6	2.9	1.6
Unsig. Movement Delay, s/veh												
LnGrp Delay(d),s/veh	51.5	45.4	54.0	64.1	45.3	46.7	380.7	0.2	0.5	87.4	13.1	12.6
LnGrp LOS	D	D	D	E	D	D	F	A	A	F	B	B
Approach Vol, veh/h		355			293			895			548	
Approach Delay, s/veh		52.3			57.8			99.8			18.2	
Approach LOS		D			E			F			B	
Timer - Assigned Phs	1	2		4	5	6		8				
Phs Duration (G+Y+Rc), s	8.8	95.4		33.8	16.0	88.2		33.8				
Change Period (Y+Rc), s	5.0	6.5		6.5	5.0	6.5		6.5				
Max Green Setting (Gmax), s	11.0	78.5		30.5	11.0	78.5		30.5				
Max Q Clear Time (g_c+I1), s	4.9	2.0		18.0	13.0	9.1		26.9				
Green Ext Time (p_c), s	0.0	4.1		1.0	0.0	3.4		0.4				

Intersection Summary

HCM 6th Ctrl Delay	64.4
HCM 6th LOS	E

Timings
3: Voyager Pkwy & Spectrum Loop

2024 Total AM

08/29/2022

Lane Group	EBL	EBT	EBR	WBL	WBT	WBR	NBL	NBT	NBR	SBL	SBT	SBR
Lane Configurations												
Traffic Volume (vph)	60	6	71	129	10	70	75	342	67	22	567	51
Future Volume (vph)	60	6	71	129	10	70	75	342	67	22	567	51
Turn Type	Perm	NA	Perm	Perm	NA	Perm	Prot	NA	Perm	Prot	NA	Perm
Protected Phases		4			8		5	2		1	6	
Permitted Phases	4		4	8		8			2			6
Detector Phase	4	4	4	8	8	8	5	2	2	1	6	6
Switch Phase												
Minimum Initial (s)	4.0	4.0	4.0	4.0	4.0	4.0	4.0	23.0	23.0	4.0	23.0	23.0
Minimum Split (s)	24.5	24.5	24.5	24.5	24.5	24.5	9.0	29.5	29.5	9.0	29.5	29.5
Total Split (s)	37.0	37.0	37.0	37.0	37.0	37.0	16.0	85.0	85.0	16.0	85.0	85.0
Total Split (%)	26.8%	26.8%	26.8%	26.8%	26.8%	26.8%	11.6%	61.6%	61.6%	11.6%	61.6%	61.6%
Yellow Time (s)	4.5	4.5	4.5	4.5	4.5	4.5	3.0	4.5	4.5	3.0	4.5	4.5
All-Red Time (s)	2.0	2.0	2.0	2.0	2.0	2.0	2.0	2.0	2.0	2.0	2.0	2.0
Lost Time Adjust (s)	0.0	0.0	0.0	0.0	0.0	0.0	0.0	0.0	0.0	0.0	0.0	0.0
Total Lost Time (s)	6.5	6.5	6.5	6.5	6.5	6.5	5.0	6.5	6.5	5.0	6.5	6.5
Lead/Lag							Lead	Lag	Lag	Lead	Lag	Lag
Lead-Lag Optimize?							Yes	Yes	Yes	Yes	Yes	Yes
Recall Mode	None	None	None	None	None	None	None	C-Max	C-Max	None	C-Max	C-Max
Act Effct Green (s)	19.4	19.4	19.4	19.4	19.4	19.4	11.4	97.6	97.6	7.4	89.2	89.2
Actuated g/C Ratio	0.14	0.14	0.14	0.14	0.14	0.14	0.08	0.71	0.71	0.05	0.65	0.65
v/c Ratio	0.34	0.03	0.27	0.73	0.04	0.27	0.57	0.15	0.06	0.25	0.28	0.05
Control Delay	56.5	47.5	12.1	76.8	48.0	12.2	79.4	8.7	4.1	68.5	11.9	2.3
Queue Delay	0.0	0.0	0.0	0.0	0.0	0.0	0.0	0.0	0.0	0.0	0.0	0.0
Total Delay	56.5	47.5	12.1	76.8	48.0	12.2	79.4	8.7	4.1	68.5	11.9	2.3
LOS	E	D	B	E	D	B	E	A	A	E	B	A
Approach Delay		33.2			53.8			19.0			13.0	
Approach LOS		C			D			B			B	

Intersection Summary

Cycle Length: 138
 Actuated Cycle Length: 138
 Offset: 75 (54%), Referenced to phase 2:NBT and 6:SBT, Start of Green
 Natural Cycle: 65
 Control Type: Actuated-Coordinated
 Maximum v/c Ratio: 0.73
 Intersection Signal Delay: 22.6
 Intersection Capacity Utilization 52.1%
 Analysis Period (min) 15
 Intersection LOS: C
 ICU Level of Service A

Splits and Phases: 3: Voyager Pkwy & Spectrum Loop

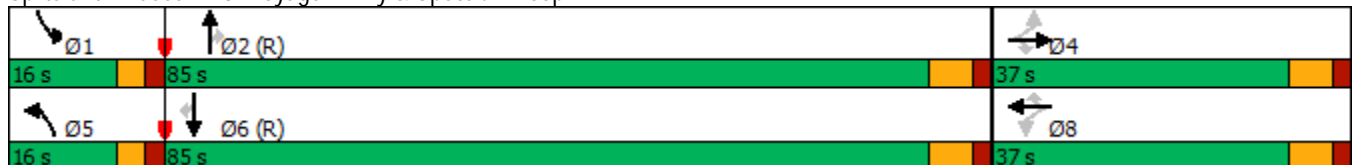

HCM 6th Signalized Intersection Summary
 3: Voyager Pkwy & Spectrum Loop

2024 Total AM
 08/29/2022



Movement	EBL	EBT	EBR	WBL	WBT	WBR	NBL	NBT	NBR	SBL	SBT	SBR
Lane Configurations	↖	↑	↗	↖	↑	↗	↖	↑↑	↗	↖	↑↑	↗
Traffic Volume (veh/h)	60	6	71	129	10	70	75	342	67	22	567	51
Future Volume (veh/h)	60	6	71	129	10	70	75	342	67	22	567	51
Initial Q (Qb), veh	0	0	0	0	0	0	0	0	0	0	0	0
Ped-Bike Adj(A_pbT)	1.00		1.00	1.00		1.00	1.00		1.00	1.00		1.00
Parking Bus, Adj	1.00	1.00	1.00	1.00	1.00	1.00	1.00	1.00	1.00	1.00	1.00	1.00
Work Zone On Approach		No			No			No			No	
Adj Sat Flow, veh/h/ln	1870	1870	1870	1870	1870	1870	1870	1870	1870	1870	1870	1870
Adj Flow Rate, veh/h	67	7	79	143	11	78	83	380	74	24	630	57
Peak Hour Factor	0.90	0.90	0.90	0.90	0.90	0.90	0.90	0.90	0.90	0.90	0.90	0.90
Percent Heavy Veh, %	2	2	2	2	2	2	2	2	2	2	2	2
Cap, veh/h	214	241	205	217	241	205	103	2570	1146	31	2426	1082
Arrive On Green	0.13	0.13	0.13	0.13	0.13	0.13	0.12	1.00	1.00	0.02	0.68	0.68
Sat Flow, veh/h	1308	1870	1585	1311	1870	1585	1781	3554	1585	1781	3554	1585
Grp Volume(v), veh/h	67	7	79	143	11	78	83	380	74	24	630	57
Grp Sat Flow(s),veh/h/ln	1308	1870	1585	1311	1870	1585	1781	1777	1585	1781	1777	1585
Q Serve(g_s), s	6.5	0.5	6.3	14.8	0.7	6.2	6.3	0.0	0.0	1.9	9.4	1.6
Cycle Q Clear(g_c), s	7.2	0.5	6.3	15.2	0.7	6.2	6.3	0.0	0.0	1.9	9.4	1.6
Prop In Lane	1.00		1.00	1.00		1.00	1.00		1.00	1.00		1.00
Lane Grp Cap(c), veh/h	214	241	205	217	241	205	103	2570	1146	31	2426	1082
V/C Ratio(X)	0.31	0.03	0.39	0.66	0.05	0.38	0.81	0.15	0.06	0.77	0.26	0.05
Avail Cap(c_a), veh/h	334	413	350	338	413	350	142	2570	1146	142	2426	1082
HCM Platoon Ratio	1.00	1.00	1.00	1.00	1.00	1.00	2.00	2.00	2.00	1.00	1.00	1.00
Upstream Filter(l)	1.00	1.00	1.00	1.00	1.00	1.00	0.99	0.99	0.99	0.90	0.90	0.90
Uniform Delay (d), s/veh	55.8	52.5	55.1	59.2	52.7	55.0	60.3	0.0	0.0	67.5	8.4	7.2
Incr Delay (d2), s/veh	0.8	0.0	1.2	3.4	0.1	1.2	20.5	0.1	0.1	29.7	0.2	0.1
Initial Q Delay(d3),s/veh	0.0	0.0	0.0	0.0	0.0	0.0	0.0	0.0	0.0	0.0	0.0	0.0
%ile BackOfQ(50%),veh/ln	2.2	0.2	2.6	5.1	0.3	2.6	3.3	0.0	0.0	1.1	3.6	0.6
Unsig. Movement Delay, s/veh												
LnGrp Delay(d),s/veh	56.6	52.6	56.3	62.6	52.7	56.2	80.8	0.1	0.1	97.2	8.7	7.3
LnGrp LOS	E	D	E	E	D	E	F	A	A	F	A	A
Approach Vol, veh/h		153			232			537			711	
Approach Delay, s/veh		56.3			60.0			12.6			11.6	
Approach LOS		E			E			B			B	
Timer - Assigned Phs	1	2		4	5	6		8				
Phs Duration (G+Y+Rc), s	7.4	106.3		24.3	13.0	100.7		24.3				
Change Period (Y+Rc), s	5.0	6.5		6.5	5.0	6.5		6.5				
Max Green Setting (Gmax), s	11.0	78.5		30.5	11.0	78.5		30.5				
Max Q Clear Time (g_c+I1), s	3.9	2.0		9.2	8.3	11.4		17.2				
Green Ext Time (p_c), s	0.0	3.1		0.4	0.0	5.3		0.6				
Intersection Summary												
HCM 6th Ctrl Delay				23.0								
HCM 6th LOS				C								

Timings 3: Voyager Pkwy & Spectrum Loop

2024 Total PM
08/29/2022



Lane Group	EBL	EBT	EBR	WBL	WBT	WBR	NBL	NBT	NBR	SBL	SBT	SBR
Lane Configurations	↖	↗	↘	↖	↗	↘	↖	↕	↘	↖	↗	↘
Traffic Volume (vph)	103	35	178	187	30	98	208	385	228	85	356	98
Future Volume (vph)	103	35	178	187	30	98	208	385	228	85	356	98
Turn Type	Perm	NA	Perm	Perm	NA	Perm	Prot	NA	Perm	Prot	NA	Perm
Protected Phases		4			8		5	2		1	6	
Permitted Phases	4		4	8		8			2			6
Detector Phase	4	4	4	8	8	8	5	2	2	1	6	6
Switch Phase												
Minimum Initial (s)	4.0	4.0	4.0	4.0	4.0	4.0	4.0	23.0	23.0	4.0	23.0	23.0
Minimum Split (s)	24.5	24.5	24.5	24.5	24.5	24.5	9.0	29.5	29.5	9.0	29.5	29.5
Total Split (s)	37.0	37.0	37.0	37.0	37.0	37.0	16.0	85.0	85.0	16.0	85.0	85.0
Total Split (%)	26.8%	26.8%	26.8%	26.8%	26.8%	26.8%	11.6%	61.6%	61.6%	11.6%	61.6%	61.6%
Yellow Time (s)	4.5	4.5	4.5	4.5	4.5	4.5	3.0	4.5	4.5	3.0	4.5	4.5
All-Red Time (s)	2.0	2.0	2.0	2.0	2.0	2.0	2.0	2.0	2.0	2.0	2.0	2.0
Lost Time Adjust (s)	0.0	0.0	0.0	0.0	0.0	0.0	0.0	0.0	0.0	0.0	0.0	0.0
Total Lost Time (s)	6.5	6.5	6.5	6.5	6.5	6.5	5.0	6.5	6.5	5.0	6.5	6.5
Lead/Lag							Lead	Lag	Lag	Lead	Lag	Lag
Lead-Lag Optimize?							Yes	Yes	Yes	Yes	Yes	Yes
Recall Mode	None	None	None	None	None	None	None	C-Max	C-Max	None	C-Max	C-Max
Act Effct Green (s)	25.4	25.4	25.4	25.4	25.4	25.4	16.1	83.6	83.6	11.0	78.5	78.5
Actuated g/C Ratio	0.18	0.18	0.18	0.18	0.18	0.18	0.12	0.61	0.61	0.08	0.57	0.57
v/c Ratio	0.46	0.11	0.44	0.84	0.10	0.29	1.14	0.20	0.24	0.69	0.20	0.12
Control Delay	55.2	45.3	8.9	80.9	45.0	9.6	156.4	13.3	2.2	85.6	14.8	2.6
Queue Delay	0.0	0.0	0.0	0.0	0.0	0.0	0.0	0.0	0.0	0.0	0.0	0.0
Total Delay	55.2	45.3	8.9	80.9	45.0	9.6	156.4	13.3	2.2	85.6	14.8	2.6
LOS	E	D	A	F	D	A	F	B	A	F	B	A
Approach Delay		28.0			55.3			46.5			23.8	
Approach LOS		C			E			D			C	

Intersection Summary

Cycle Length: 138
 Actuated Cycle Length: 138
 Offset: 75 (54%), Referenced to phase 2:NBT and 6:SBT, Start of Green
 Natural Cycle: 70
 Control Type: Actuated-Coordinated
 Maximum v/c Ratio: 1.14
 Intersection Signal Delay: 38.8 Intersection LOS: D
 Intersection Capacity Utilization 62.7% ICU Level of Service B
 Analysis Period (min) 15

Splits and Phases: 3: Voyager Pkwy & Spectrum Loop

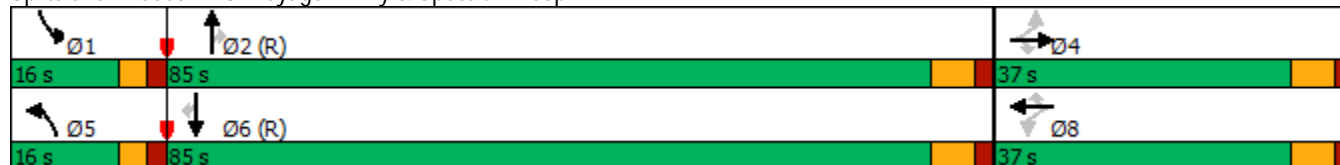

HCM 6th Signalized Intersection Summary
 3: Voyager Pkwy & Spectrum Loop

2024 Total PM
 08/29/2022



Movement	EBL	EBT	EBR	WBL	WBT	WBR	NBL	NBT	NBR	SBL	SBT	SBR
Lane Configurations	↖	↗	↘	↖	↗	↘	↖	↗	↘	↖	↗	↘
Traffic Volume (veh/h)	103	35	178	187	30	98	208	385	228	85	356	98
Future Volume (veh/h)	103	35	178	187	30	98	208	385	228	85	356	98
Initial Q (Qb), veh	0	0	0	0	0	0	0	0	0	0	0	0
Ped-Bike Adj(A_pbT)	1.00		1.00	1.00		1.00	1.00		1.00	1.00		1.00
Parking Bus, Adj	1.00	1.00	1.00	1.00	1.00	1.00	1.00	1.00	1.00	1.00	1.00	1.00
Work Zone On Approach		No			No			No			No	
Adj Sat Flow, veh/h/ln	1870	1870	1870	1870	1870	1870	1870	1870	1870	1870	1870	1870
Adj Flow Rate, veh/h	116	39	200	210	34	110	234	433	256	96	400	110
Peak Hour Factor	0.89	0.89	0.89	0.89	0.89	0.89	0.89	0.89	0.89	0.89	0.89	0.89
Percent Heavy Veh, %	2	2	2	2	2	2	2	2	2	2	2	2
Cap, veh/h	300	400	339	277	400	339	142	2096	935	118	2047	913
Arrive On Green	0.21	0.21	0.21	0.21	0.21	0.21	0.13	0.98	0.98	0.07	0.58	0.58
Sat Flow, veh/h	1244	1870	1585	1141	1870	1585	1781	3554	1585	1781	3554	1585
Grp Volume(v), veh/h	116	39	200	210	34	110	234	433	256	96	400	110
Grp Sat Flow(s),veh/h/ln	1244	1870	1585	1141	1870	1585	1781	1777	1585	1781	1777	1585
Q Serve(g_s), s	11.4	2.3	15.7	25.0	2.0	8.1	11.0	0.3	0.5	7.3	7.4	4.4
Cycle Q Clear(g_c), s	13.4	2.3	15.7	27.3	2.0	8.1	11.0	0.3	0.5	7.3	7.4	4.4
Prop In Lane	1.00		1.00	1.00		1.00	1.00		1.00	1.00		1.00
Lane Grp Cap(c), veh/h	300	400	339	277	400	339	142	2096	935	118	2047	913
V/C Ratio(X)	0.39	0.10	0.59	0.76	0.09	0.32	1.65	0.21	0.27	0.81	0.20	0.12
Avail Cap(c_a), veh/h	309	413	350	285	413	350	142	2096	935	142	2047	913
HCM Platoon Ratio	1.00	1.00	1.00	1.00	1.00	1.00	1.67	1.67	1.67	1.00	1.00	1.00
Upstream Filter(l)	1.00	1.00	1.00	1.00	1.00	1.00	1.00	1.00	1.00	0.89	0.89	0.89
Uniform Delay (d), s/veh	48.8	43.6	48.8	54.5	43.4	45.8	59.8	0.4	0.4	63.6	14.0	13.3
Incr Delay (d2), s/veh	0.8	0.1	2.5	10.9	0.1	0.6	320.9	0.2	0.7	23.0	0.2	0.2
Initial Q Delay(d3),s/veh	0.0	0.0	0.0	0.0	0.0	0.0	0.0	0.0	0.0	0.0	0.0	0.0
%ile BackOfQ(50%),veh/ln	3.6	1.1	6.5	8.0	1.0	3.3	17.3	0.2	0.3	4.1	3.1	1.6
Unsig. Movement Delay, s/veh												
LnGrp Delay(d),s/veh	49.6	43.7	51.3	65.4	43.5	46.4	380.7	0.7	1.2	86.6	14.2	13.6
LnGrp LOS	D	D	D	E	D	D	F	A	A	F	B	B
Approach Vol, veh/h		355			354			923			606	
Approach Delay, s/veh		49.9			57.4			97.2			25.5	
Approach LOS		D			E			F			C	
Timer - Assigned Phs	1	2		4	5	6		8				
Phs Duration (G+Y+Rc), s	14.1	87.9		36.0	16.0	86.0		36.0				
Change Period (Y+Rc), s	5.0	6.5		6.5	5.0	6.5		6.5				
Max Green Setting (Gmax), s	11.0	78.5		30.5	11.0	78.5		30.5				
Max Q Clear Time (g_c+I1), s	9.3	2.5		17.7	13.0	9.4		29.3				
Green Ext Time (p_c), s	0.0	4.2		1.0	0.0	3.4		0.2				

Intersection Summary

HCM 6th Ctrl Delay	64.0
HCM 6th LOS	E

Timings
3: Voyager Pkwy & Spectrum Loop

2024 Total AM - Improved

08/29/2022

Lane Group	EBL	EBT	EBR	WBL	WBT	WBR	NBL	NBT	NBR	SBL	SBT	SBR
Lane Configurations												
Traffic Volume (vph)	60	6	71	129	10	70	75	342	67	22	567	51
Future Volume (vph)	60	6	71	129	10	70	75	342	67	22	567	51
Turn Type	Perm	NA	Perm	Perm	NA	Perm	pm+pt	NA	Perm	pm+pt	NA	Perm
Protected Phases		4			8		5	2		1	6	
Permitted Phases	4		4	8		8	2		2	6		6
Detector Phase	4	4	4	8	8	8	5	2	2	1	6	6
Switch Phase												
Minimum Initial (s)	4.0	4.0	4.0	4.0	4.0	4.0	4.0	23.0	23.0	4.0	23.0	23.0
Minimum Split (s)	24.5	24.5	24.5	24.5	24.5	24.5	9.0	29.5	29.5	9.0	29.5	29.5
Total Split (s)	50.0	50.0	50.0	50.0	50.0	50.0	18.0	75.0	75.0	13.0	70.0	70.0
Total Split (%)	36.2%	36.2%	36.2%	36.2%	36.2%	36.2%	13.0%	54.3%	54.3%	9.4%	50.7%	50.7%
Yellow Time (s)	4.5	4.5	4.5	4.5	4.5	4.5	3.0	4.5	4.5	3.0	4.5	4.5
All-Red Time (s)	2.0	2.0	2.0	2.0	2.0	2.0	2.0	2.0	2.0	2.0	2.0	2.0
Lost Time Adjust (s)	0.0	0.0	0.0	0.0	0.0	0.0	0.0	0.0	0.0	0.0	0.0	0.0
Total Lost Time (s)	6.5	6.5	6.5	6.5	6.5	6.5	5.0	6.5	6.5	5.0	6.5	6.5
Lead/Lag							Lead	Lag	Lag	Lead	Lag	Lag
Lead-Lag Optimize?							Yes	Yes	Yes	Yes	Yes	Yes
Recall Mode	None	None	None	None	None	None	None	C-Max	C-Max	None	C-Max	C-Max
Act Effct Green (s)	19.5	19.5	19.5	19.5	19.5	19.5	104.9	98.7	98.7	100.8	93.3	93.3
Actuated g/C Ratio	0.14	0.14	0.14	0.14	0.14	0.14	0.76	0.72	0.72	0.73	0.68	0.68
v/c Ratio	0.34	0.03	0.27	0.72	0.04	0.27	0.14	0.15	0.06	0.03	0.26	0.05
Control Delay	56.2	47.2	12.0	76.0	47.8	12.1	12.1	16.2	11.8	4.9	9.9	1.9
Queue Delay	0.0	0.0	0.0	0.0	0.0	0.0	0.0	0.0	0.0	0.0	0.0	0.0
Total Delay	56.2	47.2	12.0	76.0	47.8	12.1	12.1	16.2	11.8	4.9	9.9	1.9
LOS	E	D	B	E	D	B	B	B	B	A	A	A
Approach Delay		33.0			53.2			15.0			9.0	
Approach LOS		C			D			B			A	

Intersection Summary

Cycle Length: 138
 Actuated Cycle Length: 138
 Offset: 75 (54%), Referenced to phase 2:NBTL and 6:SBTL, Start of Green
 Natural Cycle: 65
 Control Type: Actuated-Coordinated
 Maximum v/c Ratio: 0.72
 Intersection Signal Delay: 19.5
 Intersection LOS: B
 Intersection Capacity Utilization 52.1%
 ICU Level of Service A
 Analysis Period (min) 15

Splits and Phases: 3: Voyager Pkwy & Spectrum Loop



HCM 6th Signalized Intersection Summary
 3: Voyager Pkwy & Spectrum Loop

2024 Total AM - Improved

08/29/2022

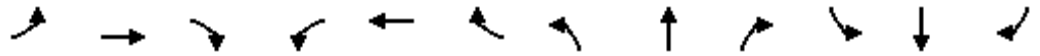

Movement	EBL	EBT	EBR	WBL	WBT	WBR	NBL	NBT	NBR	SBL	SBT	SBR
Lane Configurations												
Traffic Volume (veh/h)	60	6	71	129	10	70	75	342	67	22	567	51
Future Volume (veh/h)	60	6	71	129	10	70	75	342	67	22	567	51
Initial Q (Qb), veh	0	0	0	0	0	0	0	0	0	0	0	0
Ped-Bike Adj(A_pbT)	1.00		1.00	1.00		1.00	1.00		1.00	1.00		1.00
Parking Bus, Adj	1.00	1.00	1.00	1.00	1.00	1.00	1.00	1.00	1.00	1.00	1.00	1.00
Work Zone On Approach		No			No			No			No	
Adj Sat Flow, veh/h/ln	1870	1870	1870	1870	1870	1870	1870	1870	1870	1870	1870	1870
Adj Flow Rate, veh/h	67	7	79	143	11	78	83	380	74	24	630	57
Peak Hour Factor	0.90	0.90	0.90	0.90	0.90	0.90	0.90	0.90	0.90	0.90	0.90	0.90
Percent Heavy Veh, %	2	2	2	2	2	2	2	2	2	2	2	2
Cap, veh/h	215	243	206	218	243	206	592	2566	1145	750	2529	1128
Arrive On Green	0.13	0.13	0.13	0.13	0.13	0.13	0.06	1.00	1.00	0.02	0.71	0.71
Sat Flow, veh/h	1308	1870	1585	1311	1870	1585	1781	3554	1585	1781	3554	1585
Grp Volume(v), veh/h	67	7	79	143	11	78	83	380	74	24	630	57
Grp Sat Flow(s),veh/h/ln	1308	1870	1585	1311	1870	1585	1781	1777	1585	1781	1777	1585
Q Serve(g_s), s	6.5	0.5	6.3	14.7	0.7	6.2	1.8	0.0	0.0	0.5	8.6	1.5
Cycle Q Clear(g_c), s	7.2	0.5	6.3	15.2	0.7	6.2	1.8	0.0	0.0	0.5	8.6	1.5
Prop In Lane	1.00		1.00	1.00		1.00	1.00		1.00	1.00		1.00
Lane Grp Cap(c), veh/h	215	243	206	218	243	206	592	2566	1145	750	2529	1128
V/C Ratio(X)	0.31	0.03	0.38	0.65	0.05	0.38	0.14	0.15	0.06	0.03	0.25	0.05
Avail Cap(c_a), veh/h	458	590	500	461	590	500	711	2566	1145	822	2529	1128
HCM Platoon Ratio	1.00	1.00	1.00	1.00	1.00	1.00	2.00	2.00	2.00	1.00	1.00	1.00
Upstream Filter(l)	1.00	1.00	1.00	1.00	1.00	1.00	0.99	0.99	0.99	0.90	0.90	0.90
Uniform Delay (d), s/veh	55.7	52.4	55.0	59.1	52.5	54.9	5.1	0.0	0.0	5.1	7.0	5.9
Incr Delay (d2), s/veh	0.8	0.0	1.2	3.3	0.1	1.1	0.1	0.1	0.1	0.0	0.2	0.1
Initial Q Delay(d3),s/veh	0.0	0.0	0.0	0.0	0.0	0.0	0.0	0.0	0.0	0.0	0.0	0.0
%ile BackOfQ(50%),veh/ln	2.2	0.2	2.6	5.1	0.3	2.6	0.6	0.0	0.0	0.2	3.2	0.5
Unsig. Movement Delay, s/veh												
LnGrp Delay(d),s/veh	56.5	52.5	56.1	62.4	52.6	56.1	5.2	0.1	0.1	5.1	7.2	6.0
LnGrp LOS	E	D	E	E	D	E	A	A	A	A	A	A
Approach Vol, veh/h		153			232			537			711	
Approach Delay, s/veh		56.1			59.8			0.9			7.0	
Approach LOS		E			E			A			A	
Timer - Assigned Phs	1	2		4	5	6		8				
Phs Duration (G+Y+Rc), s	7.4	106.2		24.4	8.8	104.7		24.4				
Change Period (Y+Rc), s	5.0	6.5		6.5	5.0	6.5		6.5				
Max Green Setting (Gmax), s	8.0	68.5		43.5	13.0	63.5		43.5				
Max Q Clear Time (g_c+I1), s	2.5	2.0		9.2	3.8	10.6		17.2				
Green Ext Time (p_c), s	0.0	3.1		0.5	0.1	5.3		0.7				

Intersection Summary

HCM 6th Ctrl Delay	17.1
HCM 6th LOS	B

Timings
3: Voyager Pkwy & Spectrum Loop

2024 Total PM - Improved

08/29/2022

Lane Group	EBL	EBT	EBR	WBL	WBT	WBR	NBL	NBT	NBR	SBL	SBT	SBR
Lane Configurations												
Traffic Volume (vph)	103	35	178	187	30	98	208	385	228	85	356	98
Future Volume (vph)	103	35	178	187	30	98	208	385	228	85	356	98
Turn Type	Perm	NA	Perm	Perm	NA	Perm	pm+pt	NA	Perm	pm+pt	NA	Perm
Protected Phases		4			8		5	2		1	6	
Permitted Phases	4		4	8		8	2		2	6		6
Detector Phase	4	4	4	8	8	8	5	2	2	1	6	6
Switch Phase												
Minimum Initial (s)	4.0	4.0	4.0	4.0	4.0	4.0	4.0	23.0	23.0	4.0	23.0	23.0
Minimum Split (s)	24.5	24.5	24.5	24.5	24.5	24.5	9.0	29.5	29.5	9.0	29.5	29.5
Total Split (s)	92.0	92.0	92.0	92.0	92.0	92.0	16.0	30.0	30.0	16.0	30.0	30.0
Total Split (%)	66.7%	66.7%	66.7%	66.7%	66.7%	66.7%	11.6%	21.7%	21.7%	11.6%	21.7%	21.7%
Yellow Time (s)	4.5	4.5	4.5	4.5	4.5	4.5	3.0	4.5	4.5	3.0	4.5	4.5
All-Red Time (s)	2.0	2.0	2.0	2.0	2.0	2.0	2.0	2.0	2.0	2.0	2.0	2.0
Lost Time Adjust (s)	0.0	0.0	0.0	0.0	0.0	0.0	0.0	0.0	0.0	0.0	0.0	0.0
Total Lost Time (s)	6.5	6.5	6.5	6.5	6.5	6.5	5.0	6.5	6.5	5.0	6.5	6.5
Lead/Lag							Lead	Lag	Lag	Lead	Lag	Lag
Lead-Lag Optimize?							Yes	Yes	Yes	Yes	Yes	Yes
Recall Mode	None	None	None	None	None	None	None	C-Max	C-Max	None	C-Max	C-Max
Act Effct Green (s)	28.5	28.5	28.5	28.5	28.5	28.5	98.0	83.5	83.5	86.3	76.9	76.9
Actuated g/C Ratio	0.21	0.21	0.21	0.21	0.21	0.21	0.71	0.61	0.61	0.63	0.56	0.56
v/c Ratio	0.41	0.10	0.41	0.74	0.09	0.27	0.32	0.20	0.24	0.15	0.20	0.12
Control Delay	49.7	41.0	7.6	66.3	40.7	8.2	9.2	14.0	2.6	8.7	17.2	3.8
Queue Delay	0.0	0.0	0.0	0.0	0.0	0.0	0.0	0.0	0.0	0.0	0.0	0.0
Total Delay	49.7	41.0	7.6	66.3	40.7	8.2	9.2	14.0	2.6	8.7	17.2	3.8
LOS	D	D	A	E	D	A	A	B	A	A	B	A
Approach Delay		25.0			45.8			9.6			13.5	
Approach LOS		C			D			A			B	

Intersection Summary

Cycle Length: 138
 Actuated Cycle Length: 138
 Offset: 75 (54%), Referenced to phase 2:NBTL and 6:SBTL, Start of Green
 Natural Cycle: 65
 Control Type: Actuated-Coordinated
 Maximum v/c Ratio: 0.74
 Intersection Signal Delay: 18.8
 Intersection Capacity Utilization 62.7%
 Analysis Period (min) 15
 Intersection LOS: B
 ICU Level of Service B

Splits and Phases: 3: Voyager Pkwy & Spectrum Loop



HCM 6th Signalized Intersection Summary
 3: Voyager Pkwy & Spectrum Loop

2024 Total PM - Improved

08/29/2022

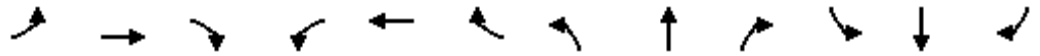

Movement	EBL	EBT	EBR	WBL	WBT	WBR	NBL	NBT	NBR	SBL	SBT	SBR
Lane Configurations	↖	↗	↘	↖	↗	↘	↖	↗	↘	↖	↗	↘
Traffic Volume (veh/h)	103	35	178	187	30	98	208	385	228	85	356	98
Future Volume (veh/h)	103	35	178	187	30	98	208	385	228	85	356	98
Initial Q (Qb), veh	0	0	0	0	0	0	0	0	0	0	0	0
Ped-Bike Adj(A_pbT)	1.00		1.00	1.00		1.00	1.00		1.00	1.00		1.00
Parking Bus, Adj	1.00	1.00	1.00	1.00	1.00	1.00	1.00	1.00	1.00	1.00	1.00	1.00
Work Zone On Approach		No			No			No			No	
Adj Sat Flow, veh/h/ln	1870	1870	1870	1870	1870	1870	1870	1870	1870	1870	1870	1870
Adj Flow Rate, veh/h	116	39	200	210	34	110	234	433	256	96	400	110
Peak Hour Factor	0.89	0.89	0.89	0.89	0.89	0.89	0.89	0.89	0.89	0.89	0.89	0.89
Percent Heavy Veh, %	2	2	2	2	2	2	2	2	2	2	2	2
Cap, veh/h	309	414	350	286	414	350	644	2176	971	553	2057	918
Arrive On Green	0.22	0.22	0.22	0.22	0.22	0.22	0.12	1.00	1.00	0.04	0.58	0.58
Sat Flow, veh/h	1244	1870	1585	1141	1870	1585	1781	3554	1585	1781	3554	1585
Grp Volume(v), veh/h	116	39	200	210	34	110	234	433	256	96	400	110
Grp Sat Flow(s),veh/h/ln	1244	1870	1585	1141	1870	1585	1781	1777	1585	1781	1777	1585
Q Serve(g_s), s	11.3	2.3	15.5	24.8	2.0	8.0	7.5	0.0	0.0	3.0	7.4	4.3
Cycle Q Clear(g_c), s	13.2	2.3	15.5	27.0	2.0	8.0	7.5	0.0	0.0	3.0	7.4	4.3
Prop In Lane	1.00		1.00	1.00		1.00	1.00		1.00	1.00		1.00
Lane Grp Cap(c), veh/h	309	414	350	286	414	350	644	2176	971	553	2057	918
V/C Ratio(X)	0.37	0.09	0.57	0.74	0.08	0.31	0.36	0.20	0.26	0.17	0.19	0.12
Avail Cap(c_a), veh/h	805	1159	982	740	1159	982	662	2176	971	631	2057	918
HCM Platoon Ratio	1.00	1.00	1.00	1.00	1.00	1.00	1.67	1.67	1.67	1.00	1.00	1.00
Upstream Filter(l)	1.00	1.00	1.00	1.00	1.00	1.00	1.00	1.00	1.00	0.89	0.89	0.89
Uniform Delay (d), s/veh	47.9	42.8	47.9	53.5	42.6	45.0	9.2	0.0	0.0	10.8	13.8	13.1
Incr Delay (d2), s/veh	0.8	0.1	1.5	3.7	0.1	0.5	0.3	0.2	0.7	0.1	0.2	0.2
Initial Q Delay(d3),s/veh	0.0	0.0	0.0	0.0	0.0	0.0	0.0	0.0	0.0	0.0	0.0	0.0
%ile BackOfQ(50%),veh/ln	3.6	1.1	6.3	7.4	0.9	3.2	2.6	0.1	0.2	1.2	3.0	1.6
Unsig. Movement Delay, s/veh												
LnGrp Delay(d),s/veh	48.6	42.8	49.4	57.2	42.7	45.5	9.5	0.2	0.7	10.9	14.0	13.4
LnGrp LOS	D	D	D	E	D	D	A	A	A	B	B	B
Approach Vol, veh/h		355			354			923			606	
Approach Delay, s/veh		48.4			52.2			2.7			13.4	
Approach LOS		D			D			A			B	
Timer - Assigned Phs	1	2		4	5	6		8				
Phs Duration (G+Y+Rc), s	10.0	91.0		37.0	14.6	86.4		37.0				
Change Period (Y+Rc), s	5.0	6.5		6.5	5.0	6.5		6.5				
Max Green Setting (Gmax), s	11.0	23.5		85.5	11.0	23.5		85.5				
Max Q Clear Time (g_c+I1), s	5.0	2.0		17.5	9.5	9.4		29.0				
Green Ext Time (p_c), s	0.1	3.8		1.3	0.1	2.6		1.5				

Intersection Summary

HCM 6th Ctrl Delay	20.7
HCM 6th LOS	C

Timings
3: Voyager Pkwy & Spectrum Loop

2045 Background AM

08/29/2022

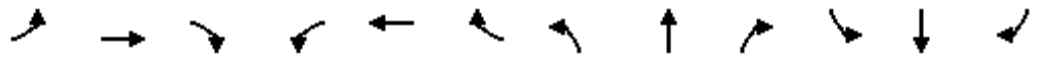

Lane Group	EBL	EBT	EBR	WBL	WBT	WBR	NBL	NBT	NBR	SBL	SBT	SBR
Lane Configurations	↖	↑	↗	↖	↑	↗	↖	↑↑	↗	↖	↑↑	↗
Traffic Volume (vph)	75	7	126	116	11	21	137	620	65	8	1034	79
Future Volume (vph)	75	7	126	116	11	21	137	620	65	8	1034	79
Turn Type	Perm	NA	Perm	Perm	NA	Perm	pm+pt	NA	Perm	pm+pt	NA	Perm
Protected Phases		4			8		5	2		1	6	
Permitted Phases	4		4	8		8	2		2	6		6
Detector Phase	4	4	4	8	8	8	5	2	2	1	6	6
Switch Phase												
Minimum Initial (s)	4.0	4.0	4.0	4.0	4.0	4.0	4.0	23.0	23.0	4.0	23.0	23.0
Minimum Split (s)	24.5	24.5	24.5	24.5	24.5	24.5	9.0	29.5	29.5	9.0	29.5	29.5
Total Split (s)	36.0	36.0	36.0	36.0	36.0	36.0	21.0	92.0	92.0	10.0	81.0	81.0
Total Split (%)	26.1%	26.1%	26.1%	26.1%	26.1%	26.1%	15.2%	66.7%	66.7%	7.2%	58.7%	58.7%
Yellow Time (s)	4.5	4.5	4.5	4.5	4.5	4.5	3.0	4.5	4.5	3.0	4.5	4.5
All-Red Time (s)	2.0	2.0	2.0	2.0	2.0	2.0	2.0	2.0	2.0	2.0	2.0	2.0
Lost Time Adjust (s)	0.0	0.0	0.0	0.0	0.0	0.0	0.0	0.0	0.0	0.0	0.0	0.0
Total Lost Time (s)	6.5	6.5	6.5	6.5	6.5	6.5	5.0	6.5	6.5	5.0	6.5	6.5
Lead/Lag							Lead	Lag	Lag	Lead	Lag	Lag
Lead-Lag Optimize?							Yes	Yes	Yes	Yes	Yes	Yes
Recall Mode	None	None	None	None	None	None	None	C-Max	C-Max	None	C-Max	C-Max
Act Effct Green (s)	17.7	17.7	17.7	17.7	17.7	17.7	108.7	105.1	105.1	101.2	94.0	94.0
Actuated g/C Ratio	0.13	0.13	0.13	0.13	0.13	0.13	0.79	0.76	0.76	0.73	0.68	0.68
v/c Ratio	0.46	0.03	0.43	0.70	0.05	0.08	0.39	0.25	0.06	0.02	0.47	0.08
Control Delay	62.6	49.3	11.9	77.3	49.9	0.5	14.3	13.5	8.0	4.5	11.9	1.2
Queue Delay	0.0	0.0	0.0	0.0	0.0	0.0	0.0	0.0	0.0	0.0	0.0	0.0
Total Delay	62.6	49.3	11.9	77.3	49.9	0.5	14.3	13.5	8.0	4.5	11.9	1.2
LOS	E	D	B	E	D	A	B	B	A	A	B	A
Approach Delay		31.5			64.3			13.2			11.1	
Approach LOS		C			E			B			B	

Intersection Summary
 Cycle Length: 138
 Actuated Cycle Length: 138
 Offset: 75 (54%), Referenced to phase 2:NBTL and 6:SBTL, Start of Green
 Natural Cycle: 65
 Control Type: Actuated-Coordinated
 Maximum v/c Ratio: 0.70
 Intersection Signal Delay: 17.1
 Intersection LOS: B
 Intersection Capacity Utilization 64.3%
 ICU Level of Service C
 Analysis Period (min) 15

Splits and Phases: 3: Voyager Pkwy & Spectrum Loop



HCM 6th Signalized Intersection Summary
 3: Voyager Pkwy & Spectrum Loop

2045 Background AM

08/29/2022



Movement	EBL	EBT	EBR	WBL	WBT	WBR	NBL	NBT	NBR	SBL	SBT	SBR
Lane Configurations												
Traffic Volume (veh/h)	75	7	126	116	11	21	137	620	65	8	1034	79
Future Volume (veh/h)	75	7	126	116	11	21	137	620	65	8	1034	79
Initial Q (Qb), veh	0	0	0	0	0	0	0	0	0	0	0	0
Ped-Bike Adj(A_pbT)	1.00		1.00	1.00		1.00	1.00		1.00	1.00		1.00
Parking Bus, Adj	1.00	1.00	1.00	1.00	1.00	1.00	1.00	1.00	1.00	1.00	1.00	1.00
Work Zone On Approach		No			No			No			No	
Adj Sat Flow, veh/h/ln	1870	1870	1870	1870	1870	1870	1870	1870	1870	1870	1870	1870
Adj Flow Rate, veh/h	82	8	137	126	12	23	149	674	71	9	1124	86
Peak Hour Factor	0.92	0.92	0.92	0.92	0.92	0.92	0.92	0.92	0.92	0.92	0.92	0.92
Percent Heavy Veh, %	2	2	2	2	2	2	2	2	2	2	2	2
Cap, veh/h	210	226	191	198	226	191	388	2631	1173	575	2520	1124
Arrive On Green	0.12	0.12	0.12	0.12	0.12	0.12	0.08	1.00	1.00	0.01	0.71	0.71
Sat Flow, veh/h	1373	1870	1585	1243	1870	1585	1781	3554	1585	1781	3554	1585
Grp Volume(v), veh/h	82	8	137	126	12	23	149	674	71	9	1124	86
Grp Sat Flow(s),veh/h/ln	1373	1870	1585	1243	1870	1585	1781	1777	1585	1781	1777	1585
Q Serve(g_s), s	7.8	0.5	11.5	13.7	0.8	1.8	3.2	0.0	0.0	0.2	18.6	2.3
Cycle Q Clear(g_c), s	8.5	0.5	11.5	14.3	0.8	1.8	3.2	0.0	0.0	0.2	18.6	2.3
Prop In Lane	1.00		1.00	1.00		1.00	1.00		1.00	1.00		1.00
Lane Grp Cap(c), veh/h	210	226	191	198	226	191	388	2631	1173	575	2520	1124
V/C Ratio(X)	0.39	0.04	0.72	0.64	0.05	0.12	0.38	0.26	0.06	0.02	0.45	0.08
Avail Cap(c_a), veh/h	338	400	339	313	400	339	524	2631	1173	624	2520	1124
HCM Platoon Ratio	1.00	1.00	1.00	1.00	1.00	1.00	2.00	2.00	2.00	1.00	1.00	1.00
Upstream Filter(l)	1.00	1.00	1.00	1.00	1.00	1.00	0.96	0.96	0.96	0.58	0.58	0.58
Uniform Delay (d), s/veh	57.5	53.6	58.4	59.9	53.7	54.1	6.2	0.0	0.0	5.5	8.5	6.2
Incr Delay (d2), s/veh	1.2	0.1	4.9	3.4	0.1	0.3	0.6	0.2	0.1	0.0	0.3	0.1
Initial Q Delay(d3),s/veh	0.0	0.0	0.0	0.0	0.0	0.0	0.0	0.0	0.0	0.0	0.0	0.0
%ile BackOfQ(50%),veh/ln	2.8	0.3	4.9	4.5	0.4	0.7	1.0	0.1	0.0	0.1	6.9	0.8
Unsig. Movement Delay, s/veh												
LnGrp Delay(d),s/veh	58.6	53.6	63.3	63.3	53.8	54.4	6.8	0.2	0.1	5.5	8.9	6.2
LnGrp LOS	E	D	E	E	D	D	A	A	A	A	A	A
Approach Vol, veh/h		227			161			894			1219	
Approach Delay, s/veh		61.3			61.3			1.3			8.7	
Approach LOS		E			E			A			A	
Timer - Assigned Phs	1	2		4	5	6		8				
Phs Duration (G+Y+Rc), s	6.2	108.7		23.2	10.5	104.4		23.2				
Change Period (Y+Rc), s	5.0	6.5		6.5	5.0	6.5		6.5				
Max Green Setting (Gmax), s	5.0	85.5		29.5	16.0	74.5		29.5				
Max Q Clear Time (g_c+I1), s	2.2	2.0		13.5	5.2	20.6		16.3				
Green Ext Time (p_c), s	0.0	5.8		0.6	0.3	11.8		0.4				

Intersection Summary

HCM 6th Ctrl Delay	14.2
HCM 6th LOS	B

Timings
3: Voyager Pkwy & Spectrum Loop

2045 Background PM

08/29/2022

Lane Group	EBL	EBT	EBR	WBL	WBT	WBR	NBL	NBT	NBR	SBL	SBT	SBR
Lane Configurations												
Traffic Volume (vph)	160	39	321	187	34	67	382	700	225	38	645	142
Future Volume (vph)	160	39	321	187	34	67	382	700	225	38	645	142
Turn Type	Perm	NA	Perm	Perm	NA	Perm	pm+pt	NA	Perm	pm+pt	NA	Perm
Protected Phases		4			8		5	2		1	6	
Permitted Phases	4		4	8		8	2		2	6		6
Detector Phase	4	4	4	8	8	8	5	2	2	1	6	6
Switch Phase												
Minimum Initial (s)	4.0	4.0	4.0	4.0	4.0	4.0	4.0	23.0	23.0	4.0	23.0	23.0
Minimum Split (s)	24.5	24.5	24.5	24.5	24.5	24.5	9.0	29.5	29.5	9.0	29.5	29.5
Total Split (s)	44.0	44.0	44.0	44.0	44.0	44.0	45.0	85.0	85.0	9.0	49.0	49.0
Total Split (%)	31.9%	31.9%	31.9%	31.9%	31.9%	31.9%	32.6%	61.6%	61.6%	6.5%	35.5%	35.5%
Yellow Time (s)	4.5	4.5	4.5	4.5	4.5	4.5	3.0	4.5	4.5	3.0	4.5	4.5
All-Red Time (s)	2.0	2.0	2.0	2.0	2.0	2.0	2.0	2.0	2.0	2.0	2.0	2.0
Lost Time Adjust (s)	0.0	0.0	0.0	0.0	0.0	0.0	0.0	0.0	0.0	0.0	0.0	0.0
Total Lost Time (s)	6.5	6.5	6.5	6.5	6.5	6.5	5.0	6.5	6.5	5.0	6.5	6.5
Lead/Lag							Lead	Lag	Lag	Lead	Lag	Lag
Lead-Lag Optimize?							Yes	Yes	Yes	Yes	Yes	Yes
Recall Mode	None	None	None	None	None	None	None	C-Max	C-Max	None	C-Max	C-Max
Act Effct Green (s)	26.0	26.0	26.0	26.0	26.0	26.0	100.5	90.0	90.0	80.3	72.7	72.7
Actuated g/C Ratio	0.19	0.19	0.19	0.19	0.19	0.19	0.73	0.65	0.65	0.58	0.53	0.53
v/c Ratio	0.68	0.12	0.60	0.79	0.11	0.19	0.69	0.33	0.22	0.09	0.38	0.17
Control Delay	64.2	44.0	8.7	74.1	43.7	3.4	14.0	12.4	2.0	10.1	23.0	4.5
Queue Delay	0.0	0.0	0.0	0.0	0.0	0.0	0.0	0.0	0.0	0.0	0.0	0.0
Total Delay	64.2	44.0	8.7	74.1	43.7	3.4	14.0	12.4	2.0	10.1	23.0	4.5
LOS	E	D	A	E	D	A	B	B	A	B	C	A
Approach Delay		28.5			54.1			11.1			19.2	
Approach LOS		C			D			B			B	

Intersection Summary

Cycle Length: 138
 Actuated Cycle Length: 138
 Offset: 75 (54%), Referenced to phase 2:NBTL and 6:SBTL, Start of Green
 Natural Cycle: 70
 Control Type: Actuated-Coordinated
 Maximum v/c Ratio: 0.79
 Intersection Signal Delay: 20.6
 Intersection LOS: C
 Intersection Capacity Utilization 72.4%
 ICU Level of Service C
 Analysis Period (min) 15

Splits and Phases: 3: Voyager Pkwy & Spectrum Loop

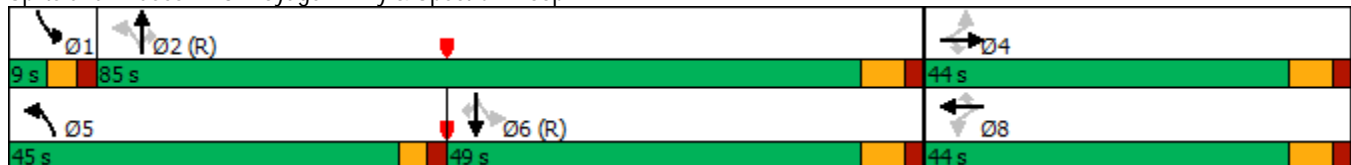

HCM 6th Signalized Intersection Summary
 3: Voyager Pkwy & Spectrum Loop

2045 Background PM

08/29/2022

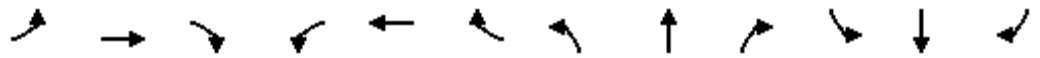

Movement	EBL	EBT	EBR	WBL	WBT	WBR	NBL	NBT	NBR	SBL	SBT	SBR
Lane Configurations	↖	↗	↘	↖	↗	↘	↖	↗	↘	↖	↗	↘
Traffic Volume (veh/h)	160	39	321	187	34	67	382	700	225	38	645	142
Future Volume (veh/h)	160	39	321	187	34	67	382	700	225	38	645	142
Initial Q (Qb), veh	0	0	0	0	0	0	0	0	0	0	0	0
Ped-Bike Adj(A_pbT)	1.00		1.00	1.00		1.00	1.00		1.00	1.00		1.00
Parking Bus, Adj	1.00	1.00	1.00	1.00	1.00	1.00	1.00	1.00	1.00	1.00	1.00	1.00
Work Zone On Approach		No			No			No			No	
Adj Sat Flow, veh/h/ln	1870	1870	1870	1870	1870	1870	1870	1870	1870	1870	1870	1870
Adj Flow Rate, veh/h	174	42	349	203	37	73	415	761	245	41	701	154
Peak Hour Factor	0.92	0.92	0.92	0.92	0.92	0.92	0.92	0.92	0.92	0.92	0.92	0.92
Percent Heavy Veh, %	2	2	2	2	2	2	2	2	2	2	2	2
Cap, veh/h	338	445	377	271	445	377	549	2163	965	362	1709	762
Arrive On Green	0.24	0.24	0.24	0.24	0.24	0.24	0.30	1.00	1.00	0.02	0.48	0.48
Sat Flow, veh/h	1283	1870	1585	993	1870	1585	1781	3554	1585	1781	3554	1585
Grp Volume(v), veh/h	174	42	349	203	37	73	415	761	245	41	701	154
Grp Sat Flow(s),veh/h/ln	1283	1870	1585	993	1870	1585	1781	1777	1585	1781	1777	1585
Q Serve(g_s), s	16.8	2.4	29.7	27.6	2.1	5.1	17.5	0.0	0.0	1.6	17.6	7.7
Cycle Q Clear(g_c), s	19.0	2.4	29.7	30.1	2.1	5.1	17.5	0.0	0.0	1.6	17.6	7.7
Prop In Lane	1.00		1.00	1.00		1.00	1.00		1.00	1.00		1.00
Lane Grp Cap(c), veh/h	338	445	377	271	445	377	549	2163	965	362	1709	762
V/C Ratio(X)	0.52	0.09	0.93	0.75	0.08	0.19	0.76	0.35	0.25	0.11	0.41	0.20
Avail Cap(c_a), veh/h	381	508	431	305	508	431	797	2163	965	373	1709	762
HCM Platoon Ratio	1.00	1.00	1.00	1.00	1.00	1.00	2.00	2.00	2.00	1.00	1.00	1.00
Upstream Filter(l)	1.00	1.00	1.00	1.00	1.00	1.00	1.00	1.00	1.00	0.59	0.59	0.59
Uniform Delay (d), s/veh	48.2	41.0	51.4	52.7	40.9	42.0	12.1	0.0	0.0	17.4	23.2	20.6
Incr Delay (d2), s/veh	1.2	0.1	24.1	8.8	0.1	0.2	2.5	0.5	0.6	0.1	0.4	0.4
Initial Q Delay(d3),s/veh	0.0	0.0	0.0	0.0	0.0	0.0	0.0	0.0	0.0	0.0	0.0	0.0
%ile BackOfQ(50%),veh/ln	5.5	1.1	14.3	7.5	1.0	2.0	4.9	0.1	0.2	0.7	7.5	3.0
Unsig. Movement Delay, s/veh												
LnGrp Delay(d),s/veh	49.5	41.1	75.5	61.5	41.0	42.2	14.6	0.5	0.6	17.5	23.6	20.9
LnGrp LOS	D	D	E	E	D	D	B	A	A	B	C	C
Approach Vol, veh/h		565			313			1421			896	
Approach Delay, s/veh		64.9			54.6			4.6			22.9	
Approach LOS		E			D			A			C	
Timer - Assigned Phs	1	2		4	5	6		8				
Phs Duration (G+Y+Rc), s	8.2	90.5		39.3	25.8	72.9		39.3				
Change Period (Y+Rc), s	5.0	6.5		6.5	5.0	6.5		6.5				
Max Green Setting (Gmax), s	4.0	78.5		37.5	40.0	42.5		37.5				
Max Q Clear Time (g_c+I1), s	3.6	2.0		31.7	19.5	19.6		32.1				
Green Ext Time (p_c), s	0.0	7.7		1.2	1.3	5.6		0.7				

Intersection Summary

HCM 6th Ctrl Delay	25.3
HCM 6th LOS	C

Timings
3: Voyager Pkwy & Spectrum Loop

2045 Total AM
08/29/2022

Lane Group	EBL	EBT	EBR	WBL	WBT	WBR	NBL	NBT	NBR	SBL	SBT	SBR
Lane Configurations												
Traffic Volume (vph)	75	7	126	141	11	72	137	620	73	23	1034	79
Future Volume (vph)	75	7	126	141	11	72	137	620	73	23	1034	79
Turn Type	Perm	NA	Perm	Perm	NA	Perm	pm+pt	NA	Perm	pm+pt	NA	Perm
Protected Phases		4			8		5	2		1	6	
Permitted Phases	4		4	8		8	2		2	6		6
Detector Phase	4	4	4	8	8	8	5	2	2	1	6	6
Switch Phase												
Minimum Initial (s)	4.0	4.0	4.0	4.0	4.0	4.0	4.0	23.0	23.0	4.0	23.0	23.0
Minimum Split (s)	24.5	24.5	24.5	24.5	24.5	24.5	9.0	29.5	29.5	9.0	29.5	29.5
Total Split (s)	50.0	50.0	50.0	50.0	50.0	50.0	18.0	75.0	75.0	13.0	70.0	70.0
Total Split (%)	36.2%	36.2%	36.2%	36.2%	36.2%	36.2%	13.0%	54.3%	54.3%	9.4%	50.7%	50.7%
Yellow Time (s)	4.5	4.5	4.5	4.5	4.5	4.5	3.0	4.5	4.5	3.0	4.5	4.5
All-Red Time (s)	2.0	2.0	2.0	2.0	2.0	2.0	2.0	2.0	2.0	2.0	2.0	2.0
Lost Time Adjust (s)	0.0	0.0	0.0	0.0	0.0	0.0	0.0	0.0	0.0	0.0	0.0	0.0
Total Lost Time (s)	6.5	6.5	6.5	6.5	6.5	6.5	5.0	6.5	6.5	5.0	6.5	6.5
Lead/Lag							Lead	Lag	Lag	Lead	Lag	Lag
Lead-Lag Optimize?							Yes	Yes	Yes	Yes	Yes	Yes
Recall Mode	None	None	None	None	None	None	None	C-Max	C-Max	None	C-Max	C-Max
Act Effct Green (s)	20.6	20.6	20.6	20.6	20.6	20.6	105.0	97.6	97.6	98.3	90.8	90.8
Actuated g/C Ratio	0.15	0.15	0.15	0.15	0.15	0.15	0.76	0.71	0.71	0.71	0.66	0.66
v/c Ratio	0.39	0.03	0.39	0.74	0.04	0.26	0.41	0.27	0.07	0.04	0.48	0.08
Control Delay	56.9	46.3	10.5	75.4	46.9	11.7	15.5	18.9	11.0	5.3	13.7	3.2
Queue Delay	0.0	0.0	0.0	0.0	0.0	0.0	0.0	0.0	0.0	0.0	0.0	0.0
Total Delay	56.9	46.3	10.5	75.4	46.9	11.7	15.5	18.9	11.0	5.3	13.7	3.2
LOS	E	D	B	E	D	B	B	B	B	A	B	A
Approach Delay		28.6			53.6			17.7			12.8	
Approach LOS		C			D			B			B	

Intersection Summary

Cycle Length: 138
 Actuated Cycle Length: 138
 Offset: 75 (54%), Referenced to phase 2:NBTL and 6:SBTL, Start of Green
 Natural Cycle: 65
 Control Type: Actuated-Coordinated
 Maximum v/c Ratio: 0.74
 Intersection Signal Delay: 19.7
 Intersection Capacity Utilization 65.7%
 Analysis Period (min) 15
 Intersection LOS: B
 ICU Level of Service C

Splits and Phases: 3: Voyager Pkwy & Spectrum Loop



HCM 6th Signalized Intersection Summary
 3: Voyager Pkwy & Spectrum Loop

2045 Total AM
 08/29/2022



Movement	EBL	EBT	EBR	WBL	WBT	WBR	NBL	NBT	NBR	SBL	SBT	SBR
Lane Configurations												
Traffic Volume (veh/h)	75	7	126	141	11	72	137	620	73	23	1034	79
Future Volume (veh/h)	75	7	126	141	11	72	137	620	73	23	1034	79
Initial Q (Qb), veh	0	0	0	0	0	0	0	0	0	0	0	0
Ped-Bike Adj(A_pbT)	1.00		1.00	1.00		1.00	1.00		1.00	1.00		1.00
Parking Bus, Adj	1.00	1.00	1.00	1.00	1.00	1.00	1.00	1.00	1.00	1.00	1.00	1.00
Work Zone On Approach		No			No			No			No	
Adj Sat Flow, veh/h/ln	1870	1870	1870	1870	1870	1870	1870	1870	1870	1870	1870	1870
Adj Flow Rate, veh/h	82	8	137	153	12	78	149	674	79	25	1124	86
Peak Hour Factor	0.92	0.92	0.92	0.92	0.92	0.92	0.92	0.92	0.92	0.92	0.92	0.92
Percent Heavy Veh, %	2	2	2	2	2	2	2	2	2	2	2	2
Cap, veh/h	234	270	229	227	270	229	375	2513	1121	569	2427	1082
Arrive On Green	0.14	0.14	0.14	0.14	0.14	0.14	0.08	1.00	1.00	0.02	0.68	0.68
Sat Flow, veh/h	1307	1870	1585	1243	1870	1585	1781	3554	1585	1781	3554	1585
Grp Volume(v), veh/h	82	8	137	153	12	78	149	674	79	25	1124	86
Grp Sat Flow(s),veh/h/ln	1307	1870	1585	1243	1870	1585	1781	1777	1585	1781	1777	1585
Q Serve(g_s), s	8.0	0.5	11.2	16.6	0.8	6.1	3.6	0.0	0.0	0.6	20.2	2.5
Cycle Q Clear(g_c), s	8.7	0.5	11.2	17.1	0.8	6.1	3.6	0.0	0.0	0.6	20.2	2.5
Prop In Lane	1.00		1.00	1.00		1.00	1.00		1.00	1.00		1.00
Lane Grp Cap(c), veh/h	234	270	229	227	270	229	375	2513	1121	569	2427	1082
V/C Ratio(X)	0.35	0.03	0.60	0.67	0.04	0.34	0.40	0.27	0.07	0.04	0.46	0.08
Avail Cap(c_a), veh/h	457	590	500	439	590	500	468	2513	1121	640	2427	1082
HCM Platoon Ratio	1.00	1.00	1.00	1.00	1.00	1.00	2.00	2.00	2.00	1.00	1.00	1.00
Upstream Filter(l)	1.00	1.00	1.00	1.00	1.00	1.00	0.96	0.96	0.96	0.66	0.66	0.66
Uniform Delay (d), s/veh	54.6	50.7	55.3	58.1	50.8	53.1	7.5	0.0	0.0	6.3	10.1	7.3
Incr Delay (d2), s/veh	0.9	0.0	2.5	3.4	0.1	0.9	0.7	0.3	0.1	0.0	0.4	0.1
Initial Q Delay(d3),s/veh	0.0	0.0	0.0	0.0	0.0	0.0	0.0	0.0	0.0	0.0	0.0	0.0
%ile BackOfQ(50%),veh/ln	2.7	0.2	4.6	5.5	0.4	2.5	1.2	0.1	0.0	0.2	7.8	0.9
Unsig. Movement Delay, s/veh												
LnGrp Delay(d),s/veh	55.5	50.7	57.7	61.5	50.9	54.0	8.2	0.3	0.1	6.3	10.6	7.4
LnGrp LOS	E	D	E	E	D	D	A	A	A	A	B	A
Approach Vol, veh/h		227			243			902			1235	
Approach Delay, s/veh		56.7			58.6			1.5			10.3	
Approach LOS		E			E			A			B	
Timer - Assigned Phs	1	2		4	5	6		8				
Phs Duration (G+Y+Rc), s	7.5	104.1		26.5	10.8	100.7		26.5				
Change Period (Y+Rc), s	5.0	6.5		6.5	5.0	6.5		6.5				
Max Green Setting (Gmax), s	8.0	68.5		43.5	13.0	63.5		43.5				
Max Q Clear Time (g_c+I1), s	2.6	2.0		13.2	5.6	22.2		19.1				
Green Ext Time (p_c), s	0.0	5.9		0.7	0.2	11.3		0.8				

Intersection Summary

HCM 6th Ctrl Delay	15.8
HCM 6th LOS	B

Timings
 3: Voyager Pkwy & Spectrum Loop

2045 Total PM

08/29/2022

Lane Group	EBL	EBT	EBR	WBL	WBT	WBR	NBL	NBT	NBR	SBL	SBT	SBR
Lane Configurations												
Traffic Volume (vph)	160	39	321	205	34	104	382	700	250	89	645	142
Future Volume (vph)	160	39	321	205	34	104	382	700	250	89	645	142
Turn Type	Perm	NA	Perm	Perm	NA	Perm	pm+pt	NA	Perm	pm+pt	NA	Perm
Protected Phases		4			8		5	2		1	6	
Permitted Phases	4		4	8		8	2		2	6		6
Detector Phase	4	4	4	8	8	8	5	2	2	1	6	6
Switch Phase												
Minimum Initial (s)	4.0	4.0	4.0	4.0	4.0	4.0	4.0	23.0	23.0	4.0	23.0	23.0
Minimum Split (s)	24.5	24.5	24.5	24.5	24.5	24.5	9.0	29.5	29.5	9.0	29.5	29.5
Total Split (s)	92.0	92.0	92.0	92.0	92.0	92.0	16.0	30.0	30.0	16.0	30.0	30.0
Total Split (%)	66.7%	66.7%	66.7%	66.7%	66.7%	66.7%	11.6%	21.7%	21.7%	11.6%	21.7%	21.7%
Yellow Time (s)	4.5	4.5	4.5	4.5	4.5	4.5	3.0	4.5	4.5	3.0	4.5	4.5
All-Red Time (s)	2.0	2.0	2.0	2.0	2.0	2.0	2.0	2.0	2.0	2.0	2.0	2.0
Lost Time Adjust (s)	0.0	0.0	0.0	0.0	0.0	0.0	0.0	0.0	0.0	0.0	0.0	0.0
Total Lost Time (s)	6.5	6.5	6.5	6.5	6.5	6.5	5.0	6.5	6.5	5.0	6.5	6.5
Lead/Lag							Lead	Lag	Lag	Lead	Lag	Lag
Lead-Lag Optimize?							Yes	Yes	Yes	Yes	Yes	Yes
Recall Mode	None	None	None	None	None	None	None	C-Max	C-Max	None	C-Max	C-Max
Act Effct Green (s)	30.2	30.2	30.2	30.2	30.2	30.2	96.3	80.8	80.8	56.3	45.8	45.8
Actuated g/C Ratio	0.22	0.22	0.22	0.22	0.22	0.22	0.70	0.59	0.59	0.41	0.33	0.33
v/c Ratio	0.58	0.10	0.56	0.75	0.09	0.26	0.58	0.37	0.27	0.28	0.60	0.25
Control Delay	54.8	39.8	7.4	65.1	39.5	7.8	17.8	17.5	4.3	15.3	40.1	6.4
Queue Delay	0.0	0.0	0.0	0.0	0.0	0.0	0.0	0.0	0.0	0.0	0.0	0.0
Total Delay	54.8	39.8	7.4	65.1	39.5	7.8	17.8	17.5	4.3	15.3	40.1	6.4
LOS	D	D	A	E	D	A	B	B	A	B	D	A
Approach Delay		24.4			45.2			15.1			32.1	
Approach LOS		C			D			B			C	

Intersection Summary

Cycle Length: 138	
Actuated Cycle Length: 138	
Offset: 75 (54%), Referenced to phase 2:NBTL and 6:SBTL, Start of Green	
Natural Cycle: 70	
Control Type: Actuated-Coordinated	
Maximum v/c Ratio: 0.75	
Intersection Signal Delay: 24.9	Intersection LOS: C
Intersection Capacity Utilization 73.4%	ICU Level of Service D
Analysis Period (min) 15	

Splits and Phases: 3: Voyager Pkwy & Spectrum Loop



HCM 6th Signalized Intersection Summary
 3: Voyager Pkwy & Spectrum Loop

2045 Total PM
 08/29/2022



Movement	EBL	EBT	EBR	WBL	WBT	WBR	NBL	NBT	NBR	SBL	SBT	SBR
Lane Configurations	↖	↑	↗	↖	↑	↗	↖	↑↑	↗	↖	↑↑	↗
Traffic Volume (veh/h)	160	39	321	205	34	104	382	700	250	89	645	142
Future Volume (veh/h)	160	39	321	205	34	104	382	700	250	89	645	142
Initial Q (Qb), veh	0	0	0	0	0	0	0	0	0	0	0	0
Ped-Bike Adj(A_pbT)	1.00		1.00	1.00		1.00	1.00		1.00	1.00		1.00
Parking Bus, Adj	1.00	1.00	1.00	1.00	1.00	1.00	1.00	1.00	1.00	1.00	1.00	1.00
Work Zone On Approach		No			No			No			No	
Adj Sat Flow, veh/h/ln	1870	1870	1870	1870	1870	1870	1870	1870	1870	1870	1870	1870
Adj Flow Rate, veh/h	174	42	349	223	37	113	415	761	272	97	701	154
Peak Hour Factor	0.92	0.92	0.92	0.92	0.92	0.92	0.92	0.92	0.92	0.92	0.92	0.92
Percent Heavy Veh, %	2	2	2	2	2	2	2	2	2	2	2	2
Cap, veh/h	359	492	417	296	492	417	459	2017	900	410	1873	835
Arrive On Green	0.26	0.26	0.26	0.26	0.26	0.26	0.16	1.00	1.00	0.04	0.53	0.53
Sat Flow, veh/h	1237	1870	1585	993	1870	1585	1781	3554	1585	1781	3554	1585
Grp Volume(v), veh/h	174	42	349	223	37	113	415	761	272	97	701	154
Grp Sat Flow(s),veh/h/ln	1237	1870	1585	993	1870	1585	1781	1777	1585	1781	1777	1585
Q Serve(g_s), s	17.0	2.3	28.7	30.1	2.1	7.8	11.0	0.0	0.0	3.4	16.0	7.0
Cycle Q Clear(g_c), s	19.0	2.3	28.7	32.5	2.1	7.8	11.0	0.0	0.0	3.4	16.0	7.0
Prop In Lane	1.00		1.00	1.00		1.00	1.00		1.00	1.00		1.00
Lane Grp Cap(c), veh/h	359	492	417	296	492	417	459	2017	900	410	1873	835
V/C Ratio(X)	0.48	0.09	0.84	0.75	0.08	0.27	0.90	0.38	0.30	0.24	0.37	0.18
Avail Cap(c_a), veh/h	800	1159	982	651	1159	982	459	2017	900	482	1873	835
HCM Platoon Ratio	1.00	1.00	1.00	1.00	1.00	1.00	2.00	2.00	2.00	1.00	1.00	1.00
Upstream Filter(l)	1.00	1.00	1.00	1.00	1.00	1.00	1.00	1.00	1.00	0.66	0.66	0.66
Uniform Delay (d), s/veh	45.4	38.4	48.1	50.6	38.2	40.4	24.4	0.0	0.0	13.7	19.2	17.1
Incr Delay (d2), s/veh	1.0	0.1	4.5	3.9	0.1	0.3	21.0	0.5	0.9	0.2	0.4	0.3
Initial Q Delay(d3),s/veh	0.0	0.0	0.0	0.0	0.0	0.0	0.0	0.0	0.0	0.0	0.0	0.0
%ile BackOfQ(50%),veh/ln	5.4	1.1	11.9	7.8	1.0	3.1	10.9	0.2	0.2	1.4	6.7	2.7
Unsig. Movement Delay, s/veh												
LnGrp Delay(d),s/veh	46.4	38.4	52.6	54.5	38.3	40.7	45.4	0.5	0.9	13.9	19.6	17.4
LnGrp LOS	D	D	D	D	D	D	D	A	A	B	B	B
Approach Vol, veh/h		565			373			1448			952	
Approach Delay, s/veh		49.6			48.7			13.5			18.7	
Approach LOS		D			D			B			B	
Timer - Assigned Phs	1	2		4	5	6		8				
Phs Duration (G+Y+Rc), s	10.4	84.8		42.8	16.0	79.2		42.8				
Change Period (Y+Rc), s	5.0	6.5		6.5	5.0	6.5		6.5				
Max Green Setting (Gmax), s	11.0	23.5		85.5	11.0	23.5		85.5				
Max Q Clear Time (g_c+I1), s	5.4	2.0		30.7	13.0	18.0		34.5				
Green Ext Time (p_c), s	0.1	6.5		2.2	0.0	2.5		1.8				
Intersection Summary												
HCM 6th Ctrl Delay			25.0									
HCM 6th LOS			C									

Intersection			
Intersection Delay, s/veh	3.4		
Intersection LOS	A		
Approach	EB	WB	SB
Entry Lanes	1	1	1
Conflicting Circle Lanes	1	1	1
Adj Approach Flow, veh/h	51	137	41
Demand Flow Rate, veh/h	52	140	42
Vehicles Circulating, veh/h	6	10	132
Vehicles Exiting, veh/h	168	48	18
Ped Vol Crossing Leg, #/h	0	0	0
Ped Cap Adj	1.000	1.000	1.000
Approach Delay, s/veh	3.0	3.5	3.3
Approach LOS	A	A	A
Lane	Left	Left	Left
Designated Moves	LT	TR	LR
Assumed Moves	LT	TR	LR
RT Channelized			
Lane Util	1.000	1.000	1.000
Follow-Up Headway, s	2.609	2.609	2.609
Critical Headway, s	4.976	4.976	4.976
Entry Flow, veh/h	52	140	42
Cap Entry Lane, veh/h	1371	1366	1206
Entry HV Adj Factor	0.984	0.982	0.976
Flow Entry, veh/h	51	137	41
Cap Entry, veh/h	1350	1341	1177
V/C Ratio	0.038	0.103	0.035
Control Delay, s/veh	3.0	3.5	3.3
LOS	A	A	A
95th %tile Queue, veh	0	0	0

Intersection			
Intersection Delay, s/veh	3.3		
Intersection LOS	A		
Approach	EB	WB	SB
Entry Lanes	1	1	1
Conflicting Circle Lanes	1	1	1
Adj Approach Flow, veh/h	113	85	90
Demand Flow Rate, veh/h	115	86	91
Vehicles Circulating, veh/h	20	19	76
Vehicles Exiting, veh/h	147	116	29
Ped Vol Crossing Leg, #/h	0	0	0
Ped Cap Adj	1.000	1.000	1.000
Approach Delay, s/veh	3.4	3.2	3.4
Approach LOS	A	A	A
Lane	Left	Left	Left
Designated Moves	LT	TR	LR
Assumed Moves	LT	TR	LR
RT Channelized			
Lane Util	1.000	1.000	1.000
Follow-Up Headway, s	2.609	2.609	2.609
Critical Headway, s	4.976	4.976	4.976
Entry Flow, veh/h	115	86	91
Cap Entry Lane, veh/h	1352	1353	1277
Entry HV Adj Factor	0.984	0.983	0.989
Flow Entry, veh/h	113	85	90
Cap Entry, veh/h	1330	1330	1263
V/C Ratio	0.085	0.064	0.071
Control Delay, s/veh	3.4	3.2	3.4
LOS	A	A	A
95th %tile Queue, veh	0	0	0

Intersection			
Intersection Delay, s/veh	3.4		
Intersection LOS	A		
Approach	EB	WB	SB
Entry Lanes	1	1	1
Conflicting Circle Lanes	1	1	1
Adj Approach Flow, veh/h	51	138	41
Demand Flow Rate, veh/h	52	141	42
Vehicles Circulating, veh/h	6	10	133
Vehicles Exiting, veh/h	169	48	18
Ped Vol Crossing Leg, #/h	0	0	0
Ped Cap Adj	1.000	1.000	1.000
Approach Delay, s/veh	3.0	3.5	3.3
Approach LOS	A	A	A
Lane	Left	Left	Left
Designated Moves	LT	TR	LR
Assumed Moves	LT	TR	LR
RT Channelized			
Lane Util	1.000	1.000	1.000
Follow-Up Headway, s	2.609	2.609	2.609
Critical Headway, s	4.976	4.976	4.976
Entry Flow, veh/h	52	141	42
Cap Entry Lane, veh/h	1371	1366	1205
Entry HV Adj Factor	0.984	0.982	0.976
Flow Entry, veh/h	51	138	41
Cap Entry, veh/h	1350	1341	1176
V/C Ratio	0.038	0.103	0.035
Control Delay, s/veh	3.0	3.5	3.3
LOS	A	A	A
95th %tile Queue, veh	0	0	0

Intersection			
Intersection Delay, s/veh	3.4		
Intersection LOS	A		
Approach	EB	WB	SB
Entry Lanes	1	1	1
Conflicting Circle Lanes	1	1	1
Adj Approach Flow, veh/h	114	86	92
Demand Flow Rate, veh/h	116	88	93
Vehicles Circulating, veh/h	20	19	78
Vehicles Exiting, veh/h	151	117	29
Ped Vol Crossing Leg, #/h	0	0	0
Ped Cap Adj	1.000	1.000	1.000
Approach Delay, s/veh	3.4	3.2	3.4
Approach LOS	A	A	A
Lane	Left	Left	Left
Designated Moves	LT	TR	LR
Assumed Moves	LT	TR	LR
RT Channelized			
Lane Util	1.000	1.000	1.000
Follow-Up Headway, s	2.609	2.609	2.609
Critical Headway, s	4.976	4.976	4.976
Entry Flow, veh/h	116	88	93
Cap Entry Lane, veh/h	1352	1353	1274
Entry HV Adj Factor	0.984	0.983	0.989
Flow Entry, veh/h	114	86	92
Cap Entry, veh/h	1330	1330	1261
V/C Ratio	0.086	0.065	0.073
Control Delay, s/veh	3.4	3.2	3.4
LOS	A	A	A
95th %tile Queue, veh	0	0	0

Intersection			
Intersection Delay, s/veh	3.5		
Intersection LOS	A		
Approach	EB	WB	SB
Entry Lanes	1	1	1
Conflicting Circle Lanes	1	1	1
Adj Approach Flow, veh/h	82	138	51
Demand Flow Rate, veh/h	84	141	52
Vehicles Circulating, veh/h	6	42	133
Vehicles Exiting, veh/h	179	48	50
Ped Vol Crossing Leg, #/h	0	0	0
Ped Cap Adj	1.000	1.000	1.000
Approach Delay, s/veh	3.2	3.6	3.4
Approach LOS	A	A	A
Lane	Left	Left	Left
Designated Moves	LT	TR	LR
Assumed Moves	LT	TR	LR
RT Channelized			
Lane Util	1.000	1.000	1.000
Follow-Up Headway, s	2.609	2.609	2.609
Critical Headway, s	4.976	4.976	4.976
Entry Flow, veh/h	84	141	52
Cap Entry Lane, veh/h	1371	1322	1205
Entry HV Adj Factor	0.978	0.982	0.981
Flow Entry, veh/h	82	138	51
Cap Entry, veh/h	1342	1298	1182
V/C Ratio	0.061	0.107	0.043
Control Delay, s/veh	3.2	3.6	3.4
LOS	A	A	A
95th %tile Queue, veh	0	0	0

Intersection			
Intersection Delay, s/veh	3.5		
Intersection LOS	A		
Approach	EB	WB	SB
Entry Lanes	1	1	1
Conflicting Circle Lanes	1	1	1
Adj Approach Flow, veh/h	135	86	120
Demand Flow Rate, veh/h	138	88	122
Vehicles Circulating, veh/h	20	41	78
Vehicles Exiting, veh/h	180	117	51
Ped Vol Crossing Leg, #/h	0	0	0
Ped Cap Adj	1.000	1.000	1.000
Approach Delay, s/veh	3.5	3.3	3.7
Approach LOS	A	A	A
Lane	Left	Left	Left
Designated Moves	LT	TR	LR
Assumed Moves	LT	TR	LR
RT Channelized			
Lane Util	1.000	1.000	1.000
Follow-Up Headway, s	2.609	2.609	2.609
Critical Headway, s	4.976	4.976	4.976
Entry Flow, veh/h	138	88	122
Cap Entry Lane, veh/h	1352	1323	1274
Entry HV Adj Factor	0.979	0.983	0.984
Flow Entry, veh/h	135	86	120
Cap Entry, veh/h	1324	1300	1253
V/C Ratio	0.102	0.066	0.096
Control Delay, s/veh	3.5	3.3	3.7
LOS	A	A	A
95th %tile Queue, veh	0	0	0

Intersection			
Intersection Delay, s/veh	3.3		
Intersection LOS	A		
Approach	EB	WB	SB
Entry Lanes	1	1	1
Conflicting Circle Lanes	1	1	1
Adj Approach Flow, veh/h	50	134	41
Demand Flow Rate, veh/h	51	137	42
Vehicles Circulating, veh/h	7	10	129
Vehicles Exiting, veh/h	164	48	18
Ped Vol Crossing Leg, #/h	0	0	0
Ped Cap Adj	1.000	1.000	1.000
Approach Delay, s/veh	3.0	3.5	3.3
Approach LOS	A	A	A
Lane	Left	Left	Left
Designated Moves	LT	TR	LR
Assumed Moves	LT	TR	LR
RT Channelized			
Lane Util	1.000	1.000	1.000
Follow-Up Headway, s	2.609	2.609	2.609
Critical Headway, s	4.976	4.976	4.976
Entry Flow, veh/h	51	137	42
Cap Entry Lane, veh/h	1370	1366	1210
Entry HV Adj Factor	0.984	0.982	0.976
Flow Entry, veh/h	50	134	41
Cap Entry, veh/h	1348	1341	1181
V/C Ratio	0.037	0.100	0.035
Control Delay, s/veh	3.0	3.5	3.3
LOS	A	A	A
95th %tile Queue, veh	0	0	0

Intersection			
Intersection Delay, s/veh	3.4		
Intersection LOS	A		
Approach	EB	WB	SB
Entry Lanes	1	1	1
Conflicting Circle Lanes	1	1	1
Adj Approach Flow, veh/h	122	91	98
Demand Flow Rate, veh/h	124	93	100
Vehicles Circulating, veh/h	22	21	82
Vehicles Exiting, veh/h	160	125	32
Ped Vol Crossing Leg, #/h	0	0	0
Ped Cap Adj	1.000	1.000	1.000
Approach Delay, s/veh	3.4	3.3	3.5
Approach LOS	A	A	A
Lane	Left	Left	Left
Designated Moves	LT	TR	LR
Assumed Moves	LT	TR	LR
RT Channelized			
Lane Util	1.000	1.000	1.000
Follow-Up Headway, s	2.609	2.609	2.609
Critical Headway, s	4.976	4.976	4.976
Entry Flow, veh/h	124	93	100
Cap Entry Lane, veh/h	1349	1351	1269
Entry HV Adj Factor	0.984	0.983	0.980
Flow Entry, veh/h	122	91	98
Cap Entry, veh/h	1327	1327	1244
V/C Ratio	0.092	0.069	0.079
Control Delay, s/veh	3.4	3.3	3.5
LOS	A	A	A
95th %tile Queue, veh	0	0	0

Intersection			
Intersection Delay, s/veh	3.4		
Intersection LOS	A		
Approach	EB	WB	SB
Entry Lanes	1	1	1
Conflicting Circle Lanes	1	1	1
Adj Approach Flow, veh/h	77	134	49
Demand Flow Rate, veh/h	79	137	50
Vehicles Circulating, veh/h	7	38	129
Vehicles Exiting, veh/h	172	48	46
Ped Vol Crossing Leg, #/h	0	0	0
Ped Cap Adj	1.000	1.000	1.000
Approach Delay, s/veh	3.1	3.6	3.4
Approach LOS	A	A	A
Lane	Left	Left	Left
Designated Moves	LT	TR	LR
Assumed Moves	LT	TR	LR
RT Channelized			
Lane Util	1.000	1.000	1.000
Follow-Up Headway, s	2.609	2.609	2.609
Critical Headway, s	4.976	4.976	4.976
Entry Flow, veh/h	79	137	50
Cap Entry Lane, veh/h	1370	1327	1210
Entry HV Adj Factor	0.977	0.982	0.980
Flow Entry, veh/h	77	134	49
Cap Entry, veh/h	1339	1303	1186
V/C Ratio	0.058	0.103	0.041
Control Delay, s/veh	3.1	3.6	3.4
LOS	A	A	A
95th %tile Queue, veh	0	0	0

Intersection			
Intersection Delay, s/veh	3.6		
Intersection LOS	A		
Approach	EB	WB	SB
Entry Lanes	1	1	1
Conflicting Circle Lanes	1	1	1
Adj Approach Flow, veh/h	141	91	125
Demand Flow Rate, veh/h	144	93	127
Vehicles Circulating, veh/h	22	41	82
Vehicles Exiting, veh/h	187	125	52
Ped Vol Crossing Leg, #/h	0	0	0
Ped Cap Adj	1.000	1.000	1.000
Approach Delay, s/veh	3.6	3.3	3.7
Approach LOS	A	A	A
Lane	Left	Left	Left
Designated Moves	LT	TR	LR
Assumed Moves	LT	TR	LR
RT Channelized			
Lane Util	1.000	1.000	1.000
Follow-Up Headway, s	2.609	2.609	2.609
Critical Headway, s	4.976	4.976	4.976
Entry Flow, veh/h	144	93	127
Cap Entry Lane, veh/h	1349	1323	1269
Entry HV Adj Factor	0.979	0.983	0.984
Flow Entry, veh/h	141	91	125
Cap Entry, veh/h	1321	1300	1249
V/C Ratio	0.107	0.070	0.100
Control Delay, s/veh	3.6	3.3	3.7
LOS	A	A	A
95th %tile Queue, veh	0	0	0

Timings
5: Voyager Pkwy & Powers Blvd On-Ramp

2022 Existing AM
09/06/2022



Lane Group	NBL	NBT	SBT	SBR
Lane Configurations	↙	↑↑	↑↑	↘
Traffic Volume (vph)	322	510	571	201
Future Volume (vph)	322	510	571	201
Turn Type	Prot	NA	NA	Free
Protected Phases	5	2	6	
Permitted Phases				Free
Detector Phase	5	2	6	
Switch Phase				
Minimum Initial (s)	4.0	4.0	4.0	
Minimum Split (s)	9.0	10.0	31.0	
Total Split (s)	32.0	69.0	37.0	
Total Split (%)	46.4%	100.0%	53.6%	
Yellow Time (s)	3.0	4.0	4.0	
All-Red Time (s)	2.0	2.0	2.0	
Lost Time Adjust (s)	0.0	0.0	0.0	
Total Lost Time (s)	5.0	6.0	6.0	
Lead/Lag	Lead		Lag	
Lead-Lag Optimize?	Yes		Yes	
Recall Mode	None	C-Max	C-Max	
Act Effect Green (s)	18.9	69.0	39.1	69.0
Actuated g/C Ratio	0.27	1.00	0.57	1.00
v/c Ratio	0.72	0.16	0.31	0.14
Control Delay	36.1	0.1	12.5	0.2
Queue Delay	0.1	0.0	0.0	0.0
Total Delay	36.3	0.1	12.5	0.2
LOS	D	A	B	A
Approach Delay		14.1	9.3	
Approach LOS		B	A	

Intersection Summary

Cycle Length: 69
 Actuated Cycle Length: 69
 Offset: 49 (71%), Referenced to phase 2:NBT and 6:SBT, Start of Green
 Natural Cycle: 50
 Control Type: Actuated-Coordinated
 Maximum v/c Ratio: 0.72
 Intersection Signal Delay: 11.8
 Intersection Capacity Utilization 42.8%
 Analysis Period (min) 15

Intersection LOS: B
 ICU Level of Service A

Splits and Phases: 5: Voyager Pkwy & Powers Blvd On-Ramp

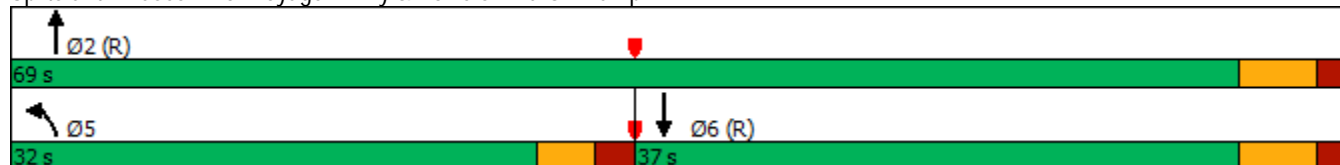

HCM 6th Signalized Intersection Summary
5: Voyager Pkwy & Powers Blvd On-Ramp

2022 Existing AM
09/06/2022



Movement	EBL	EBR	NBL	NBT	SBT	SBR
Lane Configurations			↶	↕	↕	↷
Traffic Volume (veh/h)	0	0	322	510	571	201
Future Volume (veh/h)	0	0	322	510	571	201
Initial Q (Qb), veh			0	0	0	0
Ped-Bike Adj(A_pbT)			1.00			1.00
Parking Bus, Adj			1.00	1.00	1.00	1.00
Work Zone On Approach				No	No	
Adj Sat Flow, veh/h/ln			1870	1870	1870	1870
Adj Flow Rate, veh/h			350	554	621	0
Peak Hour Factor			0.92	0.92	0.92	0.92
Percent Heavy Veh, %			2	2	2	2
Cap, veh/h			395	3245	2199	
Arrive On Green			0.44	1.00	0.20	0.00
Sat Flow, veh/h			1781	3647	3647	1585
Grp Volume(v), veh/h			350	554	621	0
Grp Sat Flow(s),veh/h/ln			1781	1777	1777	1585
Q Serve(g_s), s			12.4	0.0	10.2	0.0
Cycle Q Clear(g_c), s			12.4	0.0	10.2	0.0
Prop In Lane			1.00			1.00
Lane Grp Cap(c), veh/h			395	3245	2199	
V/C Ratio(X)			0.89	0.17	0.28	
Avail Cap(c_a), veh/h			697	3245	2199	
HCM Platoon Ratio			2.00	2.00	0.33	0.33
Upstream Filter(I)			0.98	0.98	0.96	0.00
Uniform Delay (d), s/veh			18.4	0.0	14.5	0.0
Incr Delay (d2), s/veh			6.8	0.1	0.3	0.0
Initial Q Delay(d3),s/veh			0.0	0.0	0.0	0.0
%ile BackOfQ(50%),veh/ln			4.2	0.1	4.6	0.0
Unsig. Movement Delay, s/veh						
LnGrp Delay(d),s/veh			25.2	0.1	14.8	0.0
LnGrp LOS			C	A	B	
Approach Vol, veh/h				904	621	A
Approach Delay, s/veh				9.8	14.8	
Approach LOS				A	B	
Timer - Assigned Phs		2			5	6
Phs Duration (G+Y+Rc), s		69.0			20.3	48.7
Change Period (Y+Rc), s		6.0			5.0	6.0
Max Green Setting (Gmax), s		63.0			27.0	31.0
Max Q Clear Time (g_c+I1), s		2.0			14.4	12.2
Green Ext Time (p_c), s		4.4			0.9	4.1
Intersection Summary						
HCM 6th Ctrl Delay			11.9			
HCM 6th LOS			B			

Notes

Unsignalized Delay for [SBR] is excluded from calculations of the approach delay and intersection delay.

Timings

5: Voyager Pkwy & Powers Blvd On-Ramp

2022 Existing PM
09/06/2022



Lane Group	NBL	NBT	SBT	SBR
Lane Configurations	↵	↑↑	↑↑	↵
Traffic Volume (vph)	274	729	516	184
Future Volume (vph)	274	729	516	184
Turn Type	Prot	NA	NA	Free
Protected Phases	5	2	6	
Permitted Phases				Free
Detector Phase	5	2	6	
Switch Phase				
Minimum Initial (s)	4.0	4.0	4.0	
Minimum Split (s)	9.0	10.0	31.0	
Total Split (s)	32.0	69.0	37.0	
Total Split (%)	46.4%	100.0%	53.6%	
Yellow Time (s)	3.0	4.0	4.0	
All-Red Time (s)	2.0	2.0	2.0	
Lost Time Adjust (s)	0.0	0.0	0.0	
Total Lost Time (s)	5.0	6.0	6.0	
Lead/Lag	Lead		Lag	
Lead-Lag Optimize?	Yes		Yes	
Recall Mode	None	C-Max	C-Max	
Act Effect Green (s)	16.6	69.0	41.4	69.0
Actuated g/C Ratio	0.24	1.00	0.60	1.00
v/c Ratio	0.68	0.22	0.26	0.12
Control Delay	32.6	0.2	8.1	0.2
Queue Delay	0.0	0.0	0.0	0.0
Total Delay	32.6	0.2	8.1	0.2
LOS	C	A	A	A
Approach Delay		9.0	6.0	
Approach LOS		A	A	

Intersection Summary

Cycle Length: 69
 Actuated Cycle Length: 69
 Offset: 49 (71%), Referenced to phase 2:NBT and 6:SBT, Start of Green
 Natural Cycle: 45
 Control Type: Actuated-Coordinated
 Maximum v/c Ratio: 0.68
 Intersection Signal Delay: 7.8
 Intersection LOS: A
 Intersection Capacity Utilization 38.6%
 ICU Level of Service A
 Analysis Period (min) 15

Splits and Phases: 5: Voyager Pkwy & Powers Blvd On-Ramp

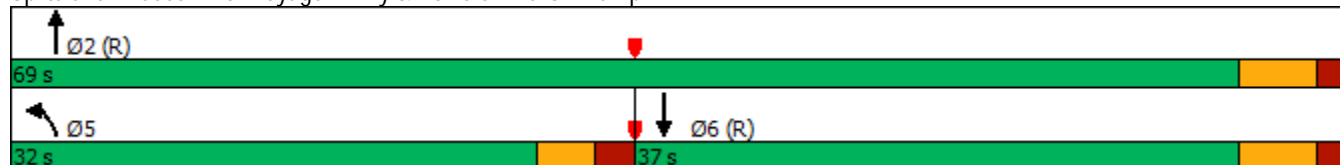

HCM 6th Signalized Intersection Summary
5: Voyager Pkwy & Powers Blvd On-Ramp

2022 Existing PM
09/06/2022



Movement	EBL	EBR	NBL	NBT	SBT	SBR
Lane Configurations			↶	↕	↕	↷
Traffic Volume (veh/h)	0	0	274	729	516	184
Future Volume (veh/h)	0	0	274	729	516	184
Initial Q (Qb), veh			0	0	0	0
Ped-Bike Adj(A_pbT)			1.00			1.00
Parking Bus, Adj			1.00	1.00	1.00	1.00
Work Zone On Approach				No	No	
Adj Sat Flow, veh/h/ln			1870	1870	1870	1870
Adj Flow Rate, veh/h			288	767	543	0
Peak Hour Factor			0.95	0.95	0.95	0.95
Percent Heavy Veh, %			2	2	2	2
Cap, veh/h			335	3245	2319	
Arrive On Green			0.38	1.00	0.44	0.00
Sat Flow, veh/h			1781	3647	3647	1585
Grp Volume(v), veh/h			288	767	543	0
Grp Sat Flow(s),veh/h/ln			1781	1777	1777	1585
Q Serve(g_s), s			10.3	0.0	6.6	0.0
Cycle Q Clear(g_c), s			10.3	0.0	6.6	0.0
Prop In Lane			1.00			1.00
Lane Grp Cap(c), veh/h			335	3245	2319	
V/C Ratio(X)			0.86	0.24	0.23	
Avail Cap(c_a), veh/h			697	3245	2319	
HCM Platoon Ratio			2.00	2.00	0.67	0.67
Upstream Filter(l)			0.96	0.96	0.92	0.00
Uniform Delay (d), s/veh			20.7	0.0	8.6	0.0
Incr Delay (d2), s/veh			6.2	0.2	0.2	0.0
Initial Q Delay(d3),s/veh			0.0	0.0	0.0	0.0
%ile BackOfQ(50%),veh/ln			3.8	0.1	2.3	0.0
Unsig. Movement Delay, s/veh						
LnGrp Delay(d),s/veh			26.9	0.2	8.8	0.0
LnGrp LOS			C	A	A	
Approach Vol, veh/h				1055	543	A
Approach Delay, s/veh				7.5	8.8	
Approach LOS				A	A	
Timer - Assigned Phs		2			5	6
Phs Duration (G+Y+Rc), s		69.0			18.0	51.0
Change Period (Y+Rc), s		6.0			5.0	6.0
Max Green Setting (Gmax), s		63.0			27.0	31.0
Max Q Clear Time (g_c+I1), s		2.0			12.3	8.6
Green Ext Time (p_c), s		6.6			0.7	3.7
Intersection Summary						
HCM 6th Ctrl Delay			7.9			
HCM 6th LOS			A			

Notes

Unsignalized Delay for [SBR] is excluded from calculations of the approach delay and intersection delay.

Timings
5: Voyager Pkwy & Powers Blvd On-Ramp



Lane Group	NBL	NBT	SBT	SBR
Lane Configurations	↙	↑↑	↑↑	↘
Traffic Volume (vph)	342	546	616	213
Future Volume (vph)	342	546	616	213
Turn Type	Prot	NA	NA	Free
Protected Phases	5	2	6	
Permitted Phases				Free
Detector Phase	5	2	6	
Switch Phase				
Minimum Initial (s)	4.0	4.0	4.0	
Minimum Split (s)	9.0	10.0	31.0	
Total Split (s)	32.0	69.0	37.0	
Total Split (%)	46.4%	100.0%	53.6%	
Yellow Time (s)	3.0	4.0	4.0	
All-Red Time (s)	2.0	2.0	2.0	
Lost Time Adjust (s)	0.0	0.0	0.0	
Total Lost Time (s)	5.0	6.0	6.0	
Lead/Lag	Lead		Lag	
Lead-Lag Optimize?	Yes		Yes	
Recall Mode	None	C-Max	C-Max	
Act Effect Green (s)	19.7	69.0	38.3	69.0
Actuated g/C Ratio	0.29	1.00	0.56	1.00
v/c Ratio	0.74	0.17	0.34	0.15
Control Delay	36.8	0.1	13.5	0.2
Queue Delay	0.2	0.0	0.0	0.0
Total Delay	36.9	0.1	13.5	0.2
LOS	D	A	B	A
Approach Delay		14.3	10.1	
Approach LOS		B	B	

Intersection Summary

Cycle Length: 69
 Actuated Cycle Length: 69
 Offset: 49 (71%), Referenced to phase 2:NBT and 6:SBT, Start of Green
 Natural Cycle: 50
 Control Type: Actuated-Coordinated
 Maximum v/c Ratio: 0.74
 Intersection Signal Delay: 12.3
 Intersection LOS: B
 Intersection Capacity Utilization 45.1%
 ICU Level of Service A
 Analysis Period (min) 15

Splits and Phases: 5: Voyager Pkwy & Powers Blvd On-Ramp

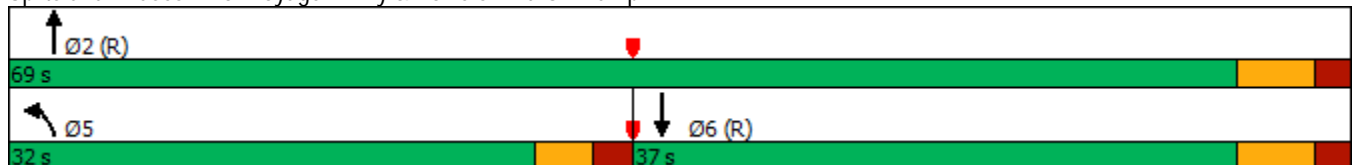

HCM 6th Signalized Intersection Summary

5: Voyager Pkwy & Powers Blvd On-Ramp

2024 Background AM

09/06/2022



Movement	EBL	EBR	NBL	NBT	SBT	SBR
Lane Configurations			↶	↷	↷	↶
Traffic Volume (veh/h)	0	0	342	546	616	213
Future Volume (veh/h)	0	0	342	546	616	213
Initial Q (Qb), veh			0	0	0	0
Ped-Bike Adj(A_pbT)			1.00			1.00
Parking Bus, Adj			1.00	1.00	1.00	1.00
Work Zone On Approach				No	No	
Adj Sat Flow, veh/h/ln			1870	1870	1870	1870
Adj Flow Rate, veh/h			372	593	670	0
Peak Hour Factor			0.92	0.92	0.92	0.92
Percent Heavy Veh, %			2	2	2	2
Cap, veh/h			416	3245	2158	
Arrive On Green			0.47	1.00	0.41	0.00
Sat Flow, veh/h			1781	3647	3647	1585
Grp Volume(v), veh/h			372	593	670	0
Grp Sat Flow(s),veh/h/ln			1781	1777	1777	1585
Q Serve(g_s), s			13.2	0.0	8.8	0.0
Cycle Q Clear(g_c), s			13.2	0.0	8.8	0.0
Prop In Lane			1.00			1.00
Lane Grp Cap(c), veh/h			416	3245	2158	
V/C Ratio(X)			0.89	0.18	0.31	
Avail Cap(c_a), veh/h			697	3245	2158	
HCM Platoon Ratio			2.00	2.00	0.67	0.67
Upstream Filter(l)			0.98	0.98	0.95	0.00
Uniform Delay (d), s/veh			17.6	0.0	10.7	0.0
Incr Delay (d2), s/veh			8.2	0.1	0.4	0.0
Initial Q Delay(d3),s/veh			0.0	0.0	0.0	0.0
%ile BackOfQ(50%),veh/ln			4.5	0.1	3.4	0.0
Unsig. Movement Delay, s/veh						
LnGrp Delay(d),s/veh			25.9	0.1	11.0	0.0
LnGrp LOS			C	A	B	
Approach Vol, veh/h				965	670	A
Approach Delay, s/veh				10.0	11.0	
Approach LOS				B	B	
Timer - Assigned Phs		2			5	6
Phs Duration (G+Y+Rc), s		69.0			21.1	47.9
Change Period (Y+Rc), s		6.0			5.0	6.0
Max Green Setting (Gmax), s		63.0			27.0	31.0
Max Q Clear Time (g_c+I1), s		2.0			15.2	10.8
Green Ext Time (p_c), s		4.7			0.9	4.6
Intersection Summary						
HCM 6th Ctrl Delay			10.4			
HCM 6th LOS			B			

Notes

Unsignalized Delay for [SBR] is excluded from calculations of the approach delay and intersection delay.

Timings

5: Voyager Pkwy & Powers Blvd On-Ramp



Lane Group	NBL	NBT	SBT	SBR
Lane Configurations	↙	↑↑	↑↑	↘
Traffic Volume (vph)	295	781	556	195
Future Volume (vph)	295	781	556	195
Turn Type	Prot	NA	NA	Free
Protected Phases	5	2	6	
Permitted Phases				Free
Detector Phase	5	2	6	
Switch Phase				
Minimum Initial (s)	4.0	4.0	4.0	
Minimum Split (s)	9.0	10.0	31.0	
Total Split (s)	32.0	69.0	37.0	
Total Split (%)	46.4%	100.0%	53.6%	
Yellow Time (s)	3.0	4.0	4.0	
All-Red Time (s)	2.0	2.0	2.0	
Lost Time Adjust (s)	0.0	0.0	0.0	
Total Lost Time (s)	5.0	6.0	6.0	
Lead/Lag	Lead		Lag	
Lead-Lag Optimize?	Yes		Yes	
Recall Mode	None	C-Max	C-Max	
Act Effect Green (s)	17.5	69.0	40.5	69.0
Actuated g/C Ratio	0.25	1.00	0.59	1.00
v/c Ratio	0.70	0.23	0.28	0.13
Control Delay	32.9	0.2	8.9	0.2
Queue Delay	0.1	0.0	0.0	0.0
Total Delay	32.9	0.2	8.9	0.2
LOS	C	A	A	A
Approach Delay		9.2	6.6	
Approach LOS		A	A	

Intersection Summary

Cycle Length: 69
 Actuated Cycle Length: 69
 Offset: 49 (71%), Referenced to phase 2:NBT and 6:SBT, Start of Green
 Natural Cycle: 50
 Control Type: Actuated-Coordinated
 Maximum v/c Ratio: 0.70
 Intersection Signal Delay: 8.1
 Intersection Capacity Utilization 40.9%
 Analysis Period (min) 15

Intersection LOS: A
 ICU Level of Service A

Splits and Phases: 5: Voyager Pkwy & Powers Blvd On-Ramp

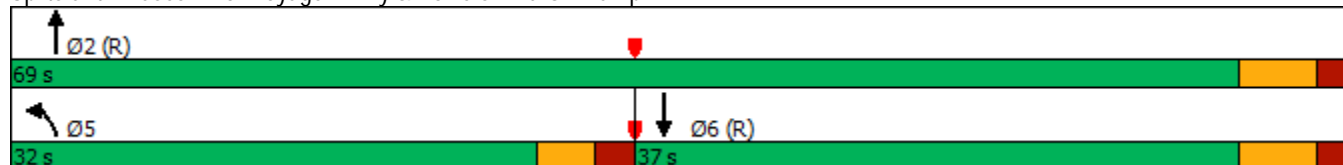

HCM 6th Signalized Intersection Summary
5: Voyager Pkwy & Powers Blvd On-Ramp

2024 Background PM

09/06/2022



Movement	EBL	EBR	NBL	NBT	SBT	SBR
Lane Configurations			↶	↷	↷	↶
Traffic Volume (veh/h)	0	0	295	781	556	195
Future Volume (veh/h)	0	0	295	781	556	195
Initial Q (Qb), veh			0	0	0	0
Ped-Bike Adj(A_pbT)			1.00			1.00
Parking Bus, Adj			1.00	1.00	1.00	1.00
Work Zone On Approach				No	No	
Adj Sat Flow, veh/h/ln			1870	1870	1870	1870
Adj Flow Rate, veh/h			311	822	585	0
Peak Hour Factor			0.95	0.95	0.95	0.95
Percent Heavy Veh, %			2	2	2	2
Cap, veh/h			357	3245	2274	
Arrive On Green			0.40	1.00	0.43	0.00
Sat Flow, veh/h			1781	3647	3647	1585
Grp Volume(v), veh/h			311	822	585	0
Grp Sat Flow(s),veh/h/ln			1781	1777	1777	1585
Q Serve(g_s), s			11.1	0.0	7.3	0.0
Cycle Q Clear(g_c), s			11.1	0.0	7.3	0.0
Prop In Lane			1.00			1.00
Lane Grp Cap(c), veh/h			357	3245	2274	
V/C Ratio(X)			0.87	0.25	0.26	
Avail Cap(c_a), veh/h			697	3245	2274	
HCM Platoon Ratio			2.00	2.00	0.67	0.67
Upstream Filter(l)			0.95	0.95	0.92	0.00
Uniform Delay (d), s/veh			19.8	0.0	9.2	0.0
Incr Delay (d2), s/veh			6.3	0.2	0.3	0.0
Initial Q Delay(d3),s/veh			0.0	0.0	0.0	0.0
%ile BackOfQ(50%),veh/ln			4.0	0.1	2.6	0.0
Unsig. Movement Delay, s/veh						
LnGrp Delay(d),s/veh			26.1	0.2	9.4	0.0
LnGrp LOS			C	A	A	
Approach Vol, veh/h				1133	585	A
Approach Delay, s/veh				7.3	9.4	
Approach LOS				A	A	
Timer - Assigned Phs		2			5	6
Phs Duration (G+Y+Rc), s		69.0			18.8	50.2
Change Period (Y+Rc), s		6.0			5.0	6.0
Max Green Setting (Gmax), s		63.0			27.0	31.0
Max Q Clear Time (g_c+I1), s		2.0			13.1	9.3
Green Ext Time (p_c), s		7.2			0.8	4.0
Intersection Summary						
HCM 6th Ctrl Delay			8.0			
HCM 6th LOS			A			
Notes						
Unsignalized Delay for [SBR] is excluded from calculations of the approach delay and intersection delay.						

Timings
5: Voyager Pkwy & Powers Blvd On-Ramp

2024 Total AM

09/06/2022



Lane Group	NBL	NBT	SBT	SBR
Lane Configurations	↙	↑↑	↑↑	↘
Traffic Volume (vph)	342	554	621	233
Future Volume (vph)	342	554	621	233
Turn Type	Prot	NA	NA	Free
Protected Phases	5	2	6	
Permitted Phases				Free
Detector Phase	5	2	6	
Switch Phase				
Minimum Initial (s)	4.0	4.0	4.0	
Minimum Split (s)	9.0	10.0	31.0	
Total Split (s)	32.0	69.0	37.0	
Total Split (%)	46.4%	100.0%	53.6%	
Yellow Time (s)	3.0	4.0	4.0	
All-Red Time (s)	2.0	2.0	2.0	
Lost Time Adjust (s)	0.0	0.0	0.0	
Total Lost Time (s)	5.0	6.0	6.0	
Lead/Lag	Lead		Lag	
Lead-Lag Optimize?	Yes		Yes	
Recall Mode	None	C-Max	C-Max	
Act Effect Green (s)	19.7	69.0	38.3	69.0
Actuated g/C Ratio	0.29	1.00	0.56	1.00
v/c Ratio	0.74	0.17	0.34	0.16
Control Delay	36.6	0.1	13.3	0.2
Queue Delay	0.2	0.0	0.0	0.0
Total Delay	36.8	0.1	13.3	0.2
LOS	D	A	B	A
Approach Delay		14.1	9.7	
Approach LOS		B	A	

Intersection Summary

Cycle Length: 69
 Actuated Cycle Length: 69
 Offset: 49 (71%), Referenced to phase 2:NBT and 6:SBT, Start of Green
 Natural Cycle: 50
 Control Type: Actuated-Coordinated
 Maximum v/c Ratio: 0.74
 Intersection Signal Delay: 12.0
 Intersection LOS: B
 Intersection Capacity Utilization 45.3%
 ICU Level of Service A
 Analysis Period (min) 15

Splits and Phases: 5: Voyager Pkwy & Powers Blvd On-Ramp

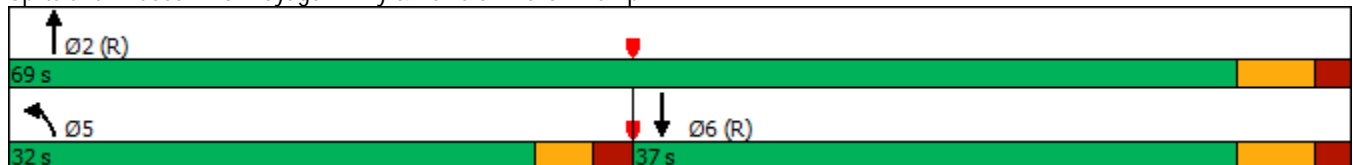

HCM 6th Signalized Intersection Summary
5: Voyager Pkwy & Powers Blvd On-Ramp

2024 Total AM
09/06/2022



Movement	EBL	EBR	NBL	NBT	SBT	SBR
Lane Configurations			↶	↷	↷	↶
Traffic Volume (veh/h)	0	0	342	554	621	233
Future Volume (veh/h)	0	0	342	554	621	233
Initial Q (Qb), veh			0	0	0	0
Ped-Bike Adj(A_pbT)			1.00			1.00
Parking Bus, Adj			1.00	1.00	1.00	1.00
Work Zone On Approach				No	No	
Adj Sat Flow, veh/h/ln			1870	1870	1870	1870
Adj Flow Rate, veh/h			372	602	675	0
Peak Hour Factor			0.92	0.92	0.92	0.92
Percent Heavy Veh, %			2	2	2	2
Cap, veh/h			416	3245	2158	
Arrive On Green			0.47	1.00	0.41	0.00
Sat Flow, veh/h			1781	3647	3647	1585
Grp Volume(v), veh/h			372	602	675	0
Grp Sat Flow(s),veh/h/ln			1781	1777	1777	1585
Q Serve(g_s), s			13.2	0.0	8.9	0.0
Cycle Q Clear(g_c), s			13.2	0.0	8.9	0.0
Prop In Lane			1.00			1.00
Lane Grp Cap(c), veh/h			416	3245	2158	
V/C Ratio(X)			0.89	0.19	0.31	
Avail Cap(c_a), veh/h			697	3245	2158	
HCM Platoon Ratio			2.00	2.00	0.67	0.67
Upstream Filter(I)			0.98	0.98	0.94	0.00
Uniform Delay (d), s/veh			17.6	0.0	10.7	0.0
Incr Delay (d2), s/veh			8.2	0.1	0.4	0.0
Initial Q Delay(d3),s/veh			0.0	0.0	0.0	0.0
%ile BackOfQ(50%),veh/ln			4.5	0.1	3.4	0.0
Unsig. Movement Delay, s/veh						
LnGrp Delay(d),s/veh			25.9	0.1	11.0	0.0
LnGrp LOS			C	A	B	
Approach Vol, veh/h				974	675	A
Approach Delay, s/veh				10.0	11.0	
Approach LOS				A	B	
Timer - Assigned Phs		2			5	6
Phs Duration (G+Y+Rc), s		69.0			21.1	47.9
Change Period (Y+Rc), s		6.0			5.0	6.0
Max Green Setting (Gmax), s		63.0			27.0	31.0
Max Q Clear Time (g_c+I1), s		2.0			15.2	10.9
Green Ext Time (p_c), s		4.8			0.9	4.6
Intersection Summary						
HCM 6th Ctrl Delay			10.4			
HCM 6th LOS			B			

Notes

Unsignalized Delay for [SBR] is excluded from calculations of the approach delay and intersection delay.

Timings
5: Voyager Pkwy & Powers Blvd On-Ramp

2024 Total PM
09/06/2022



Lane Group	NBL	NBT	SBT	SBR
Lane Configurations	↙	↑↑	↑↑	↘
Traffic Volume (vph)	295	806	560	210
Future Volume (vph)	295	806	560	210
Turn Type	Prot	NA	NA	Free
Protected Phases	5	2	6	
Permitted Phases				Free
Detector Phase	5	2	6	
Switch Phase				
Minimum Initial (s)	4.0	4.0	4.0	
Minimum Split (s)	9.0	10.0	31.0	
Total Split (s)	32.0	69.0	37.0	
Total Split (%)	46.4%	100.0%	53.6%	
Yellow Time (s)	3.0	4.0	4.0	
All-Red Time (s)	2.0	2.0	2.0	
Lost Time Adjust (s)	0.0	0.0	0.0	
Total Lost Time (s)	5.0	6.0	6.0	
Lead/Lag	Lead		Lag	
Lead-Lag Optimize?	Yes		Yes	
Recall Mode	None	C-Max	C-Max	
Act Effect Green (s)	17.5	69.0	40.5	69.0
Actuated g/C Ratio	0.25	1.00	0.59	1.00
v/c Ratio	0.70	0.24	0.28	0.14
Control Delay	32.5	0.2	8.6	0.2
Queue Delay	0.0	0.0	0.0	0.0
Total Delay	32.6	0.2	8.6	0.2
LOS	C	A	A	A
Approach Delay		8.9	6.3	
Approach LOS		A	A	

Intersection Summary

Cycle Length: 69
 Actuated Cycle Length: 69
 Offset: 49 (71%), Referenced to phase 2:NBT and 6:SBT, Start of Green
 Natural Cycle: 50
 Control Type: Actuated-Coordinated
 Maximum v/c Ratio: 0.70
 Intersection Signal Delay: 7.8
 Intersection Capacity Utilization 41.0%
 Analysis Period (min) 15

Intersection LOS: A
 ICU Level of Service A

Splits and Phases: 5: Voyager Pkwy & Powers Blvd On-Ramp

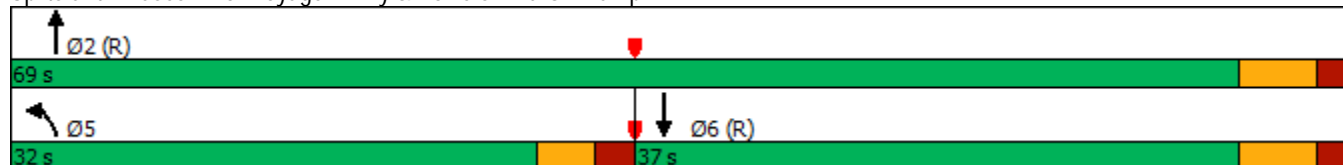

HCM 6th Signalized Intersection Summary
5: Voyager Pkwy & Powers Blvd On-Ramp

2024 Total PM
09/06/2022



Movement	EBL	EBR	NBL	NBT	SBT	SBR
Lane Configurations			↶	↷	↷	↶
Traffic Volume (veh/h)	0	0	295	806	560	210
Future Volume (veh/h)	0	0	295	806	560	210
Initial Q (Qb), veh			0	0	0	0
Ped-Bike Adj(A_pbT)			1.00			1.00
Parking Bus, Adj			1.00	1.00	1.00	1.00
Work Zone On Approach				No	No	
Adj Sat Flow, veh/h/ln			1870	1870	1870	1870
Adj Flow Rate, veh/h			311	848	589	0
Peak Hour Factor			0.95	0.95	0.95	0.95
Percent Heavy Veh, %			2	2	2	2
Cap, veh/h			357	3245	2274	
Arrive On Green			0.40	1.00	0.43	0.00
Sat Flow, veh/h			1781	3647	3647	1585
Grp Volume(v), veh/h			311	848	589	0
Grp Sat Flow(s),veh/h/ln			1781	1777	1777	1585
Q Serve(g_s), s			11.1	0.0	7.3	0.0
Cycle Q Clear(g_c), s			11.1	0.0	7.3	0.0
Prop In Lane			1.00			1.00
Lane Grp Cap(c), veh/h			357	3245	2274	
V/C Ratio(X)			0.87	0.26	0.26	
Avail Cap(c_a), veh/h			697	3245	2274	
HCM Platoon Ratio			2.00	2.00	0.67	0.67
Upstream Filter(l)			0.95	0.95	0.91	0.00
Uniform Delay (d), s/veh			19.8	0.0	9.2	0.0
Incr Delay (d2), s/veh			6.3	0.2	0.3	0.0
Initial Q Delay(d3),s/veh			0.0	0.0	0.0	0.0
%ile BackOfQ(50%),veh/ln			4.0	0.1	2.6	0.0
Unsig. Movement Delay, s/veh						
LnGrp Delay(d),s/veh			26.1	0.2	9.4	0.0
LnGrp LOS			C	A	A	
Approach Vol, veh/h				1159	589	A
Approach Delay, s/veh				7.1	9.4	
Approach LOS				A	A	
Timer - Assigned Phs		2			5	6
Phs Duration (G+Y+Rc), s		69.0			18.8	50.2
Change Period (Y+Rc), s		6.0			5.0	6.0
Max Green Setting (Gmax), s		63.0			27.0	31.0
Max Q Clear Time (g_c+I1), s		2.0			13.1	9.3
Green Ext Time (p_c), s		7.5			0.8	4.1
Intersection Summary						
HCM 6th Ctrl Delay			7.9			
HCM 6th LOS			A			

Notes

Unsignalized Delay for [SBR] is excluded from calculations of the approach delay and intersection delay.

Timings
5: Voyager Pkwy & Powers Blvd On-Ramp



Lane Group	NBL	NBT	SBT	SBR
Lane Configurations	↙	↑↑	↑↑	↘
Traffic Volume (vph)	622	992	1117	388
Future Volume (vph)	622	992	1117	388
Turn Type	Prot	NA	NA	Free
Protected Phases	5	2	6	
Permitted Phases				Free
Detector Phase	5	2	6	
Switch Phase				
Minimum Initial (s)	4.0	4.0	4.0	
Minimum Split (s)	9.0	10.0	31.0	
Total Split (s)	32.0	69.0	37.0	
Total Split (%)	46.4%	100.0%	53.6%	
Yellow Time (s)	3.0	4.0	4.0	
All-Red Time (s)	2.0	2.0	2.0	
Lost Time Adjust (s)	0.0	0.0	0.0	
Total Lost Time (s)	5.0	6.0	6.0	
Lead/Lag	Lead		Lag	
Lead-Lag Optimize?	Yes		Yes	
Recall Mode	None	C-Max	C-Max	
Act Effect Green (s)	27.0	69.0	31.0	69.0
Actuated g/C Ratio	0.39	1.00	0.45	1.00
v/c Ratio	0.98	0.30	0.76	0.27
Control Delay	66.6	0.2	26.1	0.4
Queue Delay	39.7	0.0	0.0	0.0
Total Delay	106.3	0.2	26.1	0.4
LOS	F	A	C	A
Approach Delay		41.1	19.5	
Approach LOS		D	B	

Intersection Summary

Cycle Length: 69
 Actuated Cycle Length: 69
 Offset: 49 (71%), Referenced to phase 2:NBT and 6:SBT, Start of Green
 Natural Cycle: 65
 Control Type: Actuated-Coordinated
 Maximum v/c Ratio: 0.98
 Intersection Signal Delay: 30.7
 Intersection Capacity Utilization 74.5%
 Analysis Period (min) 15
 Intersection LOS: C
 ICU Level of Service D

Splits and Phases: 5: Voyager Pkwy & Powers Blvd On-Ramp

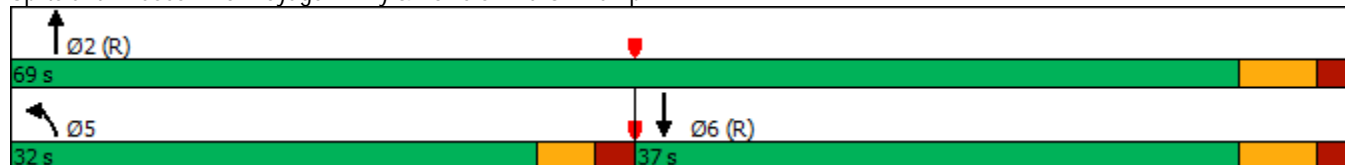

HCM 6th Signalized Intersection Summary
5: Voyager Pkwy & Powers Blvd On-Ramp

2045 Background AM
09/06/2022



Movement	EBL	EBR	NBL	NBT	SBT	SBR
Lane Configurations			↶	↷	↷	↶
Traffic Volume (veh/h)	0	0	622	992	1117	388
Future Volume (veh/h)	0	0	622	992	1117	388
Initial Q (Qb), veh			0	0	0	0
Ped-Bike Adj(A_pbT)			1.00			1.00
Parking Bus, Adj			1.00	1.00	1.00	1.00
Work Zone On Approach				No	No	
Adj Sat Flow, veh/h/ln			1870	1870	1870	1870
Adj Flow Rate, veh/h			676	1078	1214	0
Peak Hour Factor			0.92	0.92	0.92	0.92
Percent Heavy Veh, %			2	2	2	2
Cap, veh/h			689	3245	1612	
Arrive On Green			0.77	1.00	0.45	0.00
Sat Flow, veh/h			1781	3647	3647	1585
Grp Volume(v), veh/h			676	1078	1214	0
Grp Sat Flow(s),veh/h/ln			1781	1777	1777	1585
Q Serve(g_s), s			24.6	0.0	19.6	0.0
Cycle Q Clear(g_c), s			24.6	0.0	19.6	0.0
Prop In Lane			1.00			1.00
Lane Grp Cap(c), veh/h			689	3245	1612	
V/C Ratio(X)			0.98	0.33	0.75	
Avail Cap(c_a), veh/h			697	3245	1612	
HCM Platoon Ratio			2.00	2.00	1.00	1.00
Upstream Filter(l)			0.90	0.90	0.87	0.00
Uniform Delay (d), s/veh			7.6	0.0	15.6	0.0
Incr Delay (d2), s/veh			27.4	0.2	2.9	0.0
Initial Q Delay(d3),s/veh			0.0	0.0	0.0	0.0
%ile BackOfQ(50%),veh/ln			7.8	0.1	7.7	0.0
Unsig. Movement Delay, s/veh						
LnGrp Delay(d),s/veh			34.9	0.2	18.5	0.0
LnGrp LOS			C	A	B	
Approach Vol, veh/h				1754	1214	A
Approach Delay, s/veh				13.6	18.5	
Approach LOS				B	B	
Timer - Assigned Phs		2			5	6
Phs Duration (G+Y+Rc), s		69.0			31.7	37.3
Change Period (Y+Rc), s		6.0			5.0	6.0
Max Green Setting (Gmax), s		63.0			27.0	31.0
Max Q Clear Time (g_c+I1), s		2.0			26.6	21.6
Green Ext Time (p_c), s		10.7			0.1	5.6
Intersection Summary						
HCM 6th Ctrl Delay			15.6			
HCM 6th LOS			B			

Notes

Unsignalized Delay for [SBR] is excluded from calculations of the approach delay and intersection delay.

Timings
5: Voyager Pkwy & Powers Blvd On-Ramp



Lane Group	NBL	NBT	SBT	SBR
Lane Configurations	↙	↑↑	↑↑	↘
Traffic Volume (vph)	534	1423	1008	355
Future Volume (vph)	534	1423	1008	355
Turn Type	Prot	NA	NA	Free
Protected Phases	5	2	6	
Permitted Phases				Free
Detector Phase	5	2	6	
Switch Phase				
Minimum Initial (s)	4.0	4.0	4.0	
Minimum Split (s)	9.0	10.0	31.0	
Total Split (s)	32.0	69.0	37.0	
Total Split (%)	46.4%	100.0%	53.6%	
Yellow Time (s)	3.0	4.0	4.0	
All-Red Time (s)	2.0	2.0	2.0	
Lost Time Adjust (s)	0.0	0.0	0.0	
Total Lost Time (s)	5.0	6.0	6.0	
Lead/Lag	Lead		Lag	
Lead-Lag Optimize?	Yes		Yes	
Recall Mode	None	C-Max	C-Max	
Act Effect Green (s)	25.0	69.0	33.0	69.0
Actuated g/C Ratio	0.36	1.00	0.48	1.00
v/c Ratio	0.88	0.42	0.63	0.24
Control Delay	44.9	0.5	18.5	0.3
Queue Delay	8.6	0.0	0.0	0.0
Total Delay	53.4	0.5	18.5	0.3
LOS	D	A	B	A
Approach Delay		15.0	13.7	
Approach LOS		B	B	

Intersection Summary

Cycle Length: 69
 Actuated Cycle Length: 69
 Offset: 49 (71%), Referenced to phase 2:NBT and 6:SBT, Start of Green
 Natural Cycle: 60
 Control Type: Actuated-Coordinated
 Maximum v/c Ratio: 0.88
 Intersection Signal Delay: 14.5
 Intersection Capacity Utilization 85.5%
 Analysis Period (min) 15

Intersection LOS: B
 ICU Level of Service E

Splits and Phases: 5: Voyager Pkwy & Powers Blvd On-Ramp

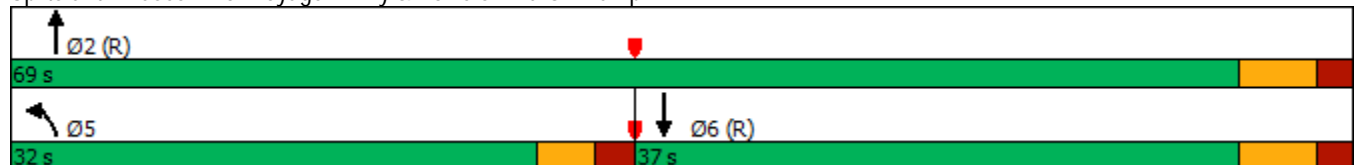

HCM 6th Signalized Intersection Summary
5: Voyager Pkwy & Powers Blvd On-Ramp

2045 Background PM
09/06/2022



Movement	EBL	EBR	NBL	NBT	SBT	SBR
Lane Configurations			↶	↷	↷	↶
Traffic Volume (veh/h)	0	0	534	1423	1008	355
Future Volume (veh/h)	0	0	534	1423	1008	355
Initial Q (Qb), veh			0	0	0	0
Ped-Bike Adj(A_pbT)			1.00			1.00
Parking Bus, Adj			1.00	1.00	1.00	1.00
Work Zone On Approach				No	No	
Adj Sat Flow, veh/h/ln			1870	1870	1870	1870
Adj Flow Rate, veh/h			562	1498	1061	0
Peak Hour Factor			0.95	0.95	0.95	0.95
Percent Heavy Veh, %			2	2	2	2
Cap, veh/h			590	3245	1809	
Arrive On Green			0.66	1.00	1.00	0.00
Sat Flow, veh/h			1781	3647	3647	1585
Grp Volume(v), veh/h			562	1498	1061	0
Grp Sat Flow(s),veh/h/ln			1781	1777	1777	1585
Q Serve(g_s), s			19.9	0.0	0.0	0.0
Cycle Q Clear(g_c), s			19.9	0.0	0.0	0.0
Prop In Lane			1.00			1.00
Lane Grp Cap(c), veh/h			590	3245	1809	
V/C Ratio(X)			0.95	0.46	0.59	
Avail Cap(c_a), veh/h			697	3245	1809	
HCM Platoon Ratio			2.00	2.00	2.00	2.00
Upstream Filter(l)			0.81	0.81	0.84	0.00
Uniform Delay (d), s/veh			11.1	0.0	0.0	0.0
Incr Delay (d2), s/veh			18.4	0.4	1.2	0.0
Initial Q Delay(d3),s/veh			0.0	0.0	0.0	0.0
%ile BackOfQ(50%),veh/ln			6.4	0.2	0.3	0.0
Unsig. Movement Delay, s/veh						
LnGrp Delay(d),s/veh			29.5	0.4	1.2	0.0
LnGrp LOS			C	A	A	
Approach Vol, veh/h				2060	1061	A
Approach Delay, s/veh				8.3	1.2	
Approach LOS				A	A	
Timer - Assigned Phs		2			5	6
Phs Duration (G+Y+Rc), s		69.0			27.9	41.1
Change Period (Y+Rc), s		6.0			5.0	6.0
Max Green Setting (Gmax), s		63.0			27.0	31.0
Max Q Clear Time (g_c+I1), s		2.0			21.9	2.0
Green Ext Time (p_c), s		19.0			1.0	9.1
Intersection Summary						
HCM 6th Ctrl Delay			5.9			
HCM 6th LOS			A			

Notes

Unsignalized Delay for [SBR] is excluded from calculations of the approach delay and intersection delay.

Timings
5: Voyager Pkwy & Powers Blvd On-Ramp

2045 Total AM
09/06/2022



Lane Group	NBL	NBT	SBT	SBR
Lane Configurations	↙	↑↑	↑↑	↘
Traffic Volume (vph)	622	1000	1122	408
Future Volume (vph)	622	1000	1122	408
Turn Type	Prot	NA	NA	Free
Protected Phases	5	2	6	
Permitted Phases				Free
Detector Phase	5	2	6	
Switch Phase				
Minimum Initial (s)	4.0	4.0	4.0	
Minimum Split (s)	9.0	10.0	31.0	
Total Split (s)	32.0	69.0	37.0	
Total Split (%)	46.4%	100.0%	53.6%	
Yellow Time (s)	3.0	4.0	4.0	
All-Red Time (s)	2.0	2.0	2.0	
Lost Time Adjust (s)	0.0	0.0	0.0	
Total Lost Time (s)	5.0	6.0	6.0	
Lead/Lag	Lead		Lag	
Lead-Lag Optimize?	Yes		Yes	
Recall Mode	None	C-Max	C-Max	
Act Effect Green (s)	27.0	69.0	31.0	69.0
Actuated g/C Ratio	0.39	1.00	0.45	1.00
v/c Ratio	0.98	0.31	0.77	0.28
Control Delay	66.7	0.2	22.6	0.4
Queue Delay	39.7	0.0	0.0	0.0
Total Delay	106.4	0.2	22.6	0.4
LOS	F	A	C	A
Approach Delay		40.9	16.7	
Approach LOS		D	B	

Intersection Summary

Cycle Length: 69
 Actuated Cycle Length: 69
 Offset: 49 (71%), Referenced to phase 2:NBT and 6:SBT, Start of Green
 Natural Cycle: 65
 Control Type: Actuated-Coordinated
 Maximum v/c Ratio: 0.98
 Intersection Signal Delay: 29.2
 Intersection LOS: C
 Intersection Capacity Utilization 74.6%
 ICU Level of Service D
 Analysis Period (min) 15

Splits and Phases: 5: Voyager Pkwy & Powers Blvd On-Ramp

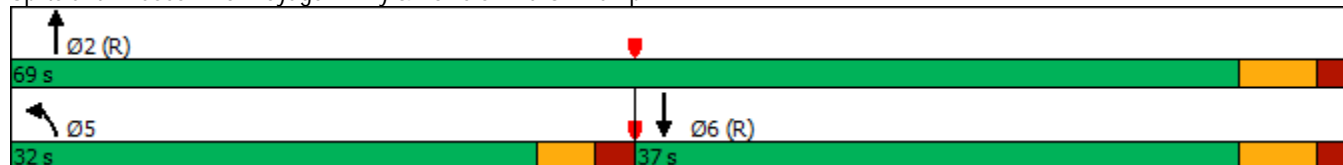

HCM 6th Signalized Intersection Summary
5: Voyager Pkwy & Powers Blvd On-Ramp

2045 Total AM
09/06/2022



Movement	EBL	EBR	NBL	NBT	SBT	SBR
Lane Configurations			↖	↑↑	↑↑	↘
Traffic Volume (veh/h)	0	0	622	1000	1122	408
Future Volume (veh/h)	0	0	622	1000	1122	408
Initial Q (Qb), veh			0	0	0	0
Ped-Bike Adj(A_pbT)			1.00			1.00
Parking Bus, Adj			1.00	1.00	1.00	1.00
Work Zone On Approach				No	No	
Adj Sat Flow, veh/h/ln			1870	1870	1870	1870
Adj Flow Rate, veh/h			676	1087	1220	0
Peak Hour Factor			0.92	0.92	0.92	0.92
Percent Heavy Veh, %			2	2	2	2
Cap, veh/h			689	3245	1612	
Arrive On Green			0.77	1.00	0.45	0.00
Sat Flow, veh/h			1781	3647	3647	1585
Grp Volume(v), veh/h			676	1087	1220	0
Grp Sat Flow(s),veh/h/ln			1781	1777	1777	1585
Q Serve(g_s), s			24.6	0.0	19.7	0.0
Cycle Q Clear(g_c), s			24.6	0.0	19.7	0.0
Prop In Lane			1.00			1.00
Lane Grp Cap(c), veh/h			689	3245	1612	
V/C Ratio(X)			0.98	0.34	0.76	
Avail Cap(c_a), veh/h			697	3245	1612	
HCM Platoon Ratio			2.00	2.00	1.00	1.00
Upstream Filter(l)			0.89	0.89	0.86	0.00
Uniform Delay (d), s/veh			7.6	0.0	15.7	0.0
Incr Delay (d2), s/veh			27.2	0.2	2.9	0.0
Initial Q Delay(d3),s/veh			0.0	0.0	0.0	0.0
%ile BackOfQ(50%),veh/ln			7.8	0.1	7.7	0.0
Unsig. Movement Delay, s/veh						
LnGrp Delay(d),s/veh			34.8	0.2	18.6	0.0
LnGrp LOS			C	A	B	
Approach Vol, veh/h				1763	1220	A
Approach Delay, s/veh				13.5	18.6	
Approach LOS				B	B	
Timer - Assigned Phs		2			5	6
Phs Duration (G+Y+Rc), s		69.0			31.7	37.3
Change Period (Y+Rc), s		6.0			5.0	6.0
Max Green Setting (Gmax), s		63.0			27.0	31.0
Max Q Clear Time (g_c+l1), s		2.0			26.6	21.7
Green Ext Time (p_c), s		10.9			0.1	5.6
Intersection Summary						
HCM 6th Ctrl Delay			15.6			
HCM 6th LOS			B			

Notes

Unsignalized Delay for [SBR] is excluded from calculations of the approach delay and intersection delay.

Timings
5: Voyager Pkwy & Powers Blvd On-Ramp

2045 Total PM
09/06/2022



Lane Group	NBL	NBT	SBT	SBR
Lane Configurations	↙	↑↑	↑↑	↙
Traffic Volume (vph)	534	1448	1012	370
Future Volume (vph)	534	1448	1012	370
Turn Type	Prot	NA	NA	Free
Protected Phases	5	2	6	
Permitted Phases				Free
Detector Phase	5	2	6	
Switch Phase				
Minimum Initial (s)	4.0	4.0	4.0	
Minimum Split (s)	9.0	10.0	31.0	
Total Split (s)	32.0	69.0	37.0	
Total Split (%)	46.4%	100.0%	53.6%	
Yellow Time (s)	3.0	4.0	4.0	
All-Red Time (s)	2.0	2.0	2.0	
Lost Time Adjust (s)	0.0	0.0	0.0	
Total Lost Time (s)	5.0	6.0	6.0	
Lead/Lag	Lead		Lag	
Lead-Lag Optimize?	Yes		Yes	
Recall Mode	None	C-Max	C-Max	
Act Effect Green (s)	25.0	69.0	33.0	69.0
Actuated g/C Ratio	0.36	1.00	0.48	1.00
v/c Ratio	0.88	0.43	0.63	0.25
Control Delay	44.1	0.6	23.1	0.3
Queue Delay	7.9	0.0	0.0	0.0
Total Delay	52.0	0.6	23.1	0.3
LOS	D	A	C	A
Approach Delay		14.4	17.0	
Approach LOS		B	B	

Intersection Summary

Cycle Length: 69
 Actuated Cycle Length: 69
 Offset: 49 (71%), Referenced to phase 2:NBT and 6:SBT, Start of Green
 Natural Cycle: 60
 Control Type: Actuated-Coordinated
 Maximum v/c Ratio: 0.88
 Intersection Signal Delay: 15.5
 Intersection LOS: B
 Intersection Capacity Utilization 86.2%
 ICU Level of Service E
 Analysis Period (min) 15

Splits and Phases: 5: Voyager Pkwy & Powers Blvd On-Ramp

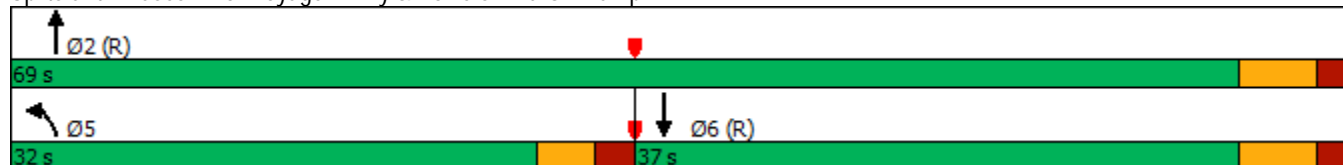

HCM 6th Signalized Intersection Summary
5: Voyager Pkwy & Powers Blvd On-Ramp

2045 Total PM
09/06/2022



Movement	EBL	EBR	NBL	NBT	SBT	SBR
Lane Configurations			↶	↷	↷	↶
Traffic Volume (veh/h)	0	0	534	1448	1012	370
Future Volume (veh/h)	0	0	534	1448	1012	370
Initial Q (Qb), veh			0	0	0	0
Ped-Bike Adj(A_pbT)			1.00			1.00
Parking Bus, Adj			1.00	1.00	1.00	1.00
Work Zone On Approach				No	No	
Adj Sat Flow, veh/h/ln			1870	1870	1870	1870
Adj Flow Rate, veh/h			562	1524	1065	0
Peak Hour Factor			0.95	0.95	0.95	0.95
Percent Heavy Veh, %			2	2	2	2
Cap, veh/h			590	3245	1809	
Arrive On Green			0.66	1.00	0.51	0.00
Sat Flow, veh/h			1781	3647	3647	1585
Grp Volume(v), veh/h			562	1524	1065	0
Grp Sat Flow(s),veh/h/ln			1781	1777	1777	1585
Q Serve(g_s), s			19.9	0.0	14.5	0.0
Cycle Q Clear(g_c), s			19.9	0.0	14.5	0.0
Prop In Lane			1.00			1.00
Lane Grp Cap(c), veh/h			590	3245	1809	
V/C Ratio(X)			0.95	0.47	0.59	
Avail Cap(c_a), veh/h			697	3245	1809	
HCM Platoon Ratio			2.00	2.00	1.00	1.00
Upstream Filter(l)			0.81	0.81	0.65	0.00
Uniform Delay (d), s/veh			11.1	0.0	11.9	0.0
Incr Delay (d2), s/veh			18.4	0.4	0.9	0.0
Initial Q Delay(d3),s/veh			0.0	0.0	0.0	0.0
%ile BackOfQ(50%),veh/ln			6.4	0.2	5.2	0.0
Unsig. Movement Delay, s/veh						
LnGrp Delay(d),s/veh			29.5	0.4	12.8	0.0
LnGrp LOS			C	A	B	
Approach Vol, veh/h				2086	1065	A
Approach Delay, s/veh				8.2	12.8	
Approach LOS				A	B	
Timer - Assigned Phs		2			5	6
Phs Duration (G+Y+Rc), s		69.0			27.9	41.1
Change Period (Y+Rc), s		6.0			5.0	6.0
Max Green Setting (Gmax), s		63.0			27.0	31.0
Max Q Clear Time (g_c+I1), s		2.0			21.9	16.5
Green Ext Time (p_c), s		19.6			1.0	6.6
Intersection Summary						
HCM 6th Ctrl Delay			9.8			
HCM 6th LOS			A			

Notes

Unsignalized Delay for [SBR] is excluded from calculations of the approach delay and intersection delay.

Timings
6: Voyager Pkwy & Powers Blvd Off-Ramp

2022 Existing AM
09/06/2022



Lane Group	EBL	EBR	NBT	SBT
Lane Configurations	↖↖	↗	↑↑↑	↑↑
Traffic Volume (vph)	110	440	728	578
Future Volume (vph)	110	440	728	578
Turn Type	Prot	Free	NA	NA
Protected Phases	4		2	6
Permitted Phases		Free		
Detector Phase	4		2	6
Switch Phase				
Minimum Initial (s)	4.0		4.0	4.0
Minimum Split (s)	24.0		24.0	33.0
Total Split (s)	31.0		38.0	38.0
Total Split (%)	44.9%		55.1%	55.1%
Yellow Time (s)	4.0		4.0	4.0
All-Red Time (s)	2.0		2.0	2.0
Lost Time Adjust (s)	0.0		0.0	0.0
Total Lost Time (s)	6.0		6.0	6.0
Lead/Lag				
Lead-Lag Optimize?				
Recall Mode	None		C-Max	C-Max
Act Effect Green (s)	6.8	69.0	53.5	53.5
Actuated g/C Ratio	0.10	1.00	0.78	0.78
v/c Ratio	0.35	0.30	0.20	0.23
Control Delay	31.5	0.5	4.5	1.8
Queue Delay	0.0	0.0	0.0	0.0
Total Delay	31.5	0.5	4.5	1.8
LOS	C	A	A	A
Approach Delay	6.7		4.5	1.8
Approach LOS	A		A	A

Intersection Summary

Cycle Length: 69
 Actuated Cycle Length: 69
 Offset: 49 (71%), Referenced to phase 2:NBT and 6:SBT, Start of Green
 Natural Cycle: 60
 Control Type: Actuated-Coordinated
 Maximum v/c Ratio: 0.35
 Intersection Signal Delay: 4.3
 Intersection Capacity Utilization 42.8%
 Analysis Period (min) 15
 Intersection LOS: A
 ICU Level of Service A

Splits and Phases: 6: Voyager Pkwy & Powers Blvd Off-Ramp

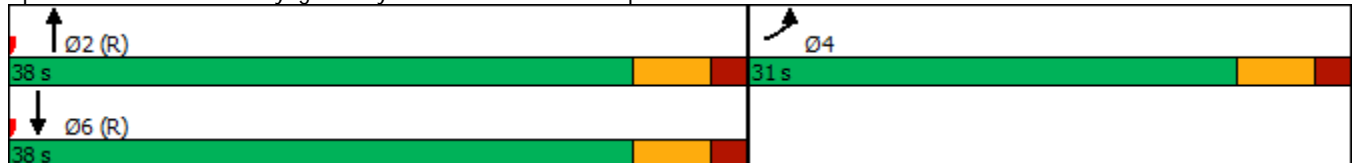

HCM 6th Signalized Intersection Summary
6: Voyager Pkwy & Powers Blvd Off-Ramp

2022 Existing AM
09/06/2022



Movement	EBL	EBR	NBL	NBT	SBT	SBR
Lane Configurations	↶↶	↷		↶↶↶	↶↶	
Traffic Volume (veh/h)	110	440	0	728	578	0
Future Volume (veh/h)	110	440	0	728	578	0
Initial Q (Qb), veh	0	0	0	0	0	0
Ped-Bike Adj(A_pbT)	1.00	1.00	1.00			1.00
Parking Bus, Adj	1.00	1.00	1.00	1.00	1.00	1.00
Work Zone On Approach	No			No	No	
Adj Sat Flow, veh/h/ln	1870	1870	0	1870	1870	0
Adj Flow Rate, veh/h	120	0	0	791	628	0
Peak Hour Factor	0.92	0.92	0.92	0.92	0.92	0.92
Percent Heavy Veh, %	2	2	0	2	2	0
Cap, veh/h	204		0	3917	2726	0
Arrive On Green	0.06	0.00	0.00	1.00	0.51	0.00
Sat Flow, veh/h	3456	1585	0	5443	3741	0
Grp Volume(v), veh/h	120	0	0	791	628	0
Grp Sat Flow(s),veh/h/ln	1728	1585	0	1702	1777	0
Q Serve(g_s), s	2.3	0.0	0.0	0.0	6.7	0.0
Cycle Q Clear(g_c), s	2.3	0.0	0.0	0.0	6.7	0.0
Prop In Lane	1.00	1.00	0.00			0.00
Lane Grp Cap(c), veh/h	204		0	3917	2726	0
V/C Ratio(X)	0.59		0.00	0.20	0.23	0.00
Avail Cap(c_a), veh/h	1252		0	3917	2726	0
HCM Platoon Ratio	1.00	1.00	1.00	2.00	0.67	1.00
Upstream Filter(I)	1.00	0.00	0.00	0.97	0.96	0.00
Uniform Delay (d), s/veh	31.7	0.0	0.0	0.0	5.5	0.0
Incr Delay (d2), s/veh	1.0	0.0	0.0	0.1	0.2	0.0
Initial Q Delay(d3),s/veh	0.0	0.0	0.0	0.0	0.0	0.0
%ile BackOfQ(50%),veh/ln	1.0	0.0	0.0	0.0	1.7	0.0
Unsig. Movement Delay, s/veh						
LnGrp Delay(d),s/veh	32.7	0.0	0.0	0.1	5.7	0.0
LnGrp LOS	C		A	A	A	A
Approach Vol, veh/h	120	A		791	628	
Approach Delay, s/veh	32.7			0.1	5.7	
Approach LOS	C			A	A	
Timer - Assigned Phs		2		4		6
Phs Duration (G+Y+Rc), s		58.9		10.1		58.9
Change Period (Y+Rc), s		6.0		6.0		6.0
Max Green Setting (Gmax), s		32.0		25.0		32.0
Max Q Clear Time (g_c+l1), s		2.0		4.3		8.7
Green Ext Time (p_c), s		4.1		0.2		3.0
Intersection Summary						
HCM 6th Ctrl Delay			4.9			
HCM 6th LOS			A			

Notes

Unsignalized Delay for [EBR] is excluded from calculations of the approach delay and intersection delay.

Timings
6: Voyager Pkwy & Powers Blvd Off-Ramp

2022 Existing PM
09/06/2022



Lane Group	EBL	EBR	NBT	SBT
Lane Configurations	↖↖	↗	↑↑↑	↑↑
Traffic Volume (vph)	272	329	730	482
Future Volume (vph)	272	329	730	482
Turn Type	Prot	Free	NA	NA
Protected Phases	4		2	6
Permitted Phases		Free		
Detector Phase	4		2	6
Switch Phase				
Minimum Initial (s)	4.0		4.0	4.0
Minimum Split (s)	24.0		24.0	33.0
Total Split (s)	31.0		38.0	38.0
Total Split (%)	44.9%		55.1%	55.1%
Yellow Time (s)	4.0		4.0	4.0
All-Red Time (s)	2.0		2.0	2.0
Lost Time Adjust (s)	0.0		0.0	0.0
Total Lost Time (s)	6.0		6.0	6.0
Lead/Lag				
Lead-Lag Optimize?				
Recall Mode	None		C-Max	C-Max
Act Effect Green (s)	10.2	69.0	46.8	46.8
Actuated g/C Ratio	0.15	1.00	0.68	0.68
v/c Ratio	0.56	0.22	0.22	0.21
Control Delay	31.4	0.3	7.0	1.1
Queue Delay	0.0	0.0	0.0	0.0
Total Delay	31.4	0.3	7.0	1.1
LOS	C	A	A	A
Approach Delay	14.4		7.0	1.1
Approach LOS	B		A	A

Intersection Summary

Cycle Length: 69
 Actuated Cycle Length: 69
 Offset: 49 (71%), Referenced to phase 2:NBT and 6:SBT, Start of Green
 Natural Cycle: 60
 Control Type: Actuated-Coordinated
 Maximum v/c Ratio: 0.56
 Intersection Signal Delay: 7.9
 Intersection Capacity Utilization 38.6%
 Analysis Period (min) 15
 Intersection LOS: A
 ICU Level of Service A

Splits and Phases: 6: Voyager Pkwy & Powers Blvd Off-Ramp

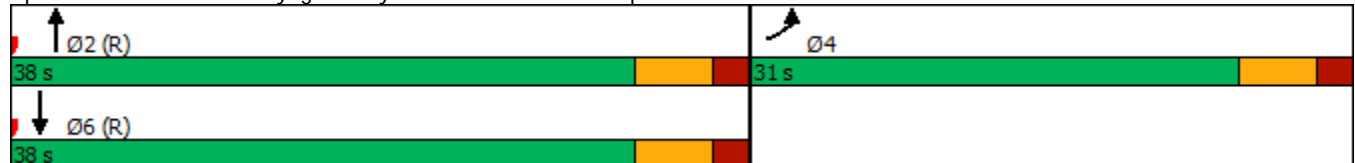

HCM 6th Signalized Intersection Summary
6: Voyager Pkwy & Powers Blvd Off-Ramp

2022 Existing PM
09/06/2022



Movement	EBL	EBR	NBL	NBT	SBT	SBR
Lane Configurations	↖↗	↗		↑↑↑	↑↑	
Traffic Volume (veh/h)	272	329	0	730	482	0
Future Volume (veh/h)	272	329	0	730	482	0
Initial Q (Qb), veh	0	0	0	0	0	0
Ped-Bike Adj(A_pbT)	1.00	1.00	1.00			1.00
Parking Bus, Adj	1.00	1.00	1.00	1.00	1.00	1.00
Work Zone On Approach	No			No	No	
Adj Sat Flow, veh/h/ln	1870	1870	0	1870	1870	0
Adj Flow Rate, veh/h	286	0	0	768	507	0
Peak Hour Factor	0.95	0.95	0.95	0.95	0.95	0.95
Percent Heavy Veh, %	2	2	0	2	2	0
Cap, veh/h	399		0	3629	2526	0
Arrive On Green	0.12	0.00	0.00	0.71	0.23	0.00
Sat Flow, veh/h	3456	1585	0	5443	3741	0
Grp Volume(v), veh/h	286	0	0	768	507	0
Grp Sat Flow(s),veh/h/ln	1728	1585	0	1702	1777	0
Q Serve(g_s), s	5.5	0.0	0.0	3.5	7.9	0.0
Cycle Q Clear(g_c), s	5.5	0.0	0.0	3.5	7.9	0.0
Prop In Lane	1.00	1.00	0.00			0.00
Lane Grp Cap(c), veh/h	399		0	3629	2526	0
V/C Ratio(X)	0.72		0.00	0.21	0.20	0.00
Avail Cap(c_a), veh/h	1252		0	3629	2526	0
HCM Platoon Ratio	1.00	1.00	1.00	1.00	0.33	1.00
Upstream Filter(l)	1.00	0.00	0.00	0.96	0.98	0.00
Uniform Delay (d), s/veh	29.4	0.0	0.0	3.4	10.7	0.0
Incr Delay (d2), s/veh	0.9	0.0	0.0	0.1	0.2	0.0
Initial Q Delay(d3),s/veh	0.0	0.0	0.0	0.0	0.0	0.0
%ile BackOfQ(50%),veh/ln	2.2	0.0	0.0	0.8	2.9	0.0
Unsig. Movement Delay, s/veh						
LnGrp Delay(d),s/veh	30.3	0.0	0.0	3.5	10.8	0.0
LnGrp LOS	C		A	A	B	A
Approach Vol, veh/h	286	A		768	507	
Approach Delay, s/veh	30.3			3.5	10.8	
Approach LOS	C			A	B	
Timer - Assigned Phs		2		4		6
Phs Duration (G+Y+Rc), s		55.0		14.0		55.0
Change Period (Y+Rc), s		6.0		6.0		6.0
Max Green Setting (Gmax), s		32.0		25.0		32.0
Max Q Clear Time (g_c+I1), s		5.5		7.5		9.9
Green Ext Time (p_c), s		3.9		0.5		2.3
Intersection Summary						
HCM 6th Ctrl Delay			10.8			
HCM 6th LOS			B			
Notes						
Unsignalized Delay for [EBR] is excluded from calculations of the approach delay and intersection delay.						

Timings
6: Voyager Pkwy & Powers Blvd Off-Ramp



Lane Group	EBL	EBR	NBT	SBT
Lane Configurations	↖↖	↗	↑↑↑	↑↑
Traffic Volume (vph)	116	468	778	623
Future Volume (vph)	116	468	778	623
Turn Type	Prot	Free	NA	NA
Protected Phases	4		2	6
Permitted Phases		Free		
Detector Phase	4		2	6
Switch Phase				
Minimum Initial (s)	4.0		4.0	4.0
Minimum Split (s)	24.0		24.0	33.0
Total Split (s)	31.0		38.0	38.0
Total Split (%)	44.9%		55.1%	55.1%
Yellow Time (s)	4.0		4.0	4.0
All-Red Time (s)	2.0		2.0	2.0
Lost Time Adjust (s)	0.0		0.0	0.0
Total Lost Time (s)	6.0		6.0	6.0
Lead/Lag				
Lead-Lag Optimize?				
Recall Mode	None		C-Max	C-Max
Act Effect Green (s)	6.9	69.0	53.4	53.4
Actuated g/C Ratio	0.10	1.00	0.77	0.77
v/c Ratio	0.37	0.32	0.21	0.25
Control Delay	31.5	0.5	4.8	1.6
Queue Delay	0.0	0.0	0.0	0.0
Total Delay	31.5	0.5	4.8	1.6
LOS	C	A	A	A
Approach Delay	6.7		4.8	1.6
Approach LOS	A		A	A

Intersection Summary

Cycle Length: 69
 Actuated Cycle Length: 69
 Offset: 49 (71%), Referenced to phase 2:NBT and 6:SBT, Start of Green
 Natural Cycle: 60
 Control Type: Actuated-Coordinated
 Maximum v/c Ratio: 0.37
 Intersection Signal Delay: 4.3
 Intersection LOS: A
 Intersection Capacity Utilization 45.1%
 ICU Level of Service A
 Analysis Period (min) 15

Splits and Phases: 6: Voyager Pkwy & Powers Blvd Off-Ramp



HCM 6th Signalized Intersection Summary
6: Voyager Pkwy & Powers Blvd Off-Ramp

2024 Background AM
09/06/2022



Movement	EBL	EBR	NBL	NBT	SBT	SBR
Lane Configurations	↶↶	↷		↶↶↶	↶↶	
Traffic Volume (veh/h)	116	468	0	778	623	0
Future Volume (veh/h)	116	468	0	778	623	0
Initial Q (Qb), veh	0	0	0	0	0	0
Ped-Bike Adj(A_pbT)	1.00	1.00	1.00			1.00
Parking Bus, Adj	1.00	1.00	1.00	1.00	1.00	1.00
Work Zone On Approach	No			No	No	
Adj Sat Flow, veh/h/ln	1870	1870	0	1870	1870	0
Adj Flow Rate, veh/h	126	0	0	846	677	0
Peak Hour Factor	0.92	0.92	0.92	0.92	0.92	0.92
Percent Heavy Veh, %	2	2	0	2	2	0
Cap, veh/h	212		0	3905	2718	0
Arrive On Green	0.06	0.00	0.00	1.00	0.25	0.00
Sat Flow, veh/h	3456	1585	0	5443	3741	0
Grp Volume(v), veh/h	126	0	0	846	677	0
Grp Sat Flow(s),veh/h/ln	1728	1585	0	1702	1777	0
Q Serve(g_s), s	2.5	0.0	0.0	0.0	10.5	0.0
Cycle Q Clear(g_c), s	2.5	0.0	0.0	0.0	10.5	0.0
Prop In Lane	1.00	1.00	0.00			0.00
Lane Grp Cap(c), veh/h	212		0	3905	2718	0
V/C Ratio(X)	0.59		0.00	0.22	0.25	0.00
Avail Cap(c_a), veh/h	1252		0	3905	2718	0
HCM Platoon Ratio	1.00	1.00	1.00	2.00	0.33	1.00
Upstream Filter(I)	1.00	0.00	0.00	0.97	0.95	0.00
Uniform Delay (d), s/veh	31.6	0.0	0.0	0.0	10.0	0.0
Incr Delay (d2), s/veh	1.0	0.0	0.0	0.1	0.2	0.0
Initial Q Delay(d3),s/veh	0.0	0.0	0.0	0.0	0.0	0.0
%ile BackOfQ(50%),veh/ln	1.0	0.0	0.0	0.0	4.5	0.0
Unsig. Movement Delay, s/veh						
LnGrp Delay(d),s/veh	32.5	0.0	0.0	0.1	10.2	0.0
LnGrp LOS	C		A	A	B	A
Approach Vol, veh/h	126	A		846	677	
Approach Delay, s/veh	32.5			0.1	10.2	
Approach LOS	C			A	B	
Timer - Assigned Phs		2		4		6
Phs Duration (G+Y+Rc), s		58.8		10.2		58.8
Change Period (Y+Rc), s		6.0		6.0		6.0
Max Green Setting (Gmax), s		32.0		25.0		32.0
Max Q Clear Time (g_c+I1), s		2.0		4.5		12.5
Green Ext Time (p_c), s		4.4		0.2		3.1

Intersection Summary

HCM 6th Ctrl Delay			6.7			
HCM 6th LOS			A			

Notes

Unsignalized Delay for [EBR] is excluded from calculations of the approach delay and intersection delay.

Timings
6: Voyager Pkwy & Powers Blvd Off-Ramp



Lane Group	EBL	EBR	NBT	SBT
Lane Configurations	↖↖	↗	↑↑↑	↑↑
Traffic Volume (vph)	288	349	787	520
Future Volume (vph)	288	349	787	520
Turn Type	Prot	Free	NA	NA
Protected Phases	4		2	6
Permitted Phases		Free		
Detector Phase	4		2	6
Switch Phase				
Minimum Initial (s)	4.0		4.0	4.0
Minimum Split (s)	24.0		24.0	33.0
Total Split (s)	31.0		38.0	38.0
Total Split (%)	44.9%		55.1%	55.1%
Yellow Time (s)	4.0		4.0	4.0
All-Red Time (s)	2.0		2.0	2.0
Lost Time Adjust (s)	0.0		0.0	0.0
Total Lost Time (s)	6.0		6.0	6.0
Lead/Lag				
Lead-Lag Optimize?				
Recall Mode	None		C-Max	C-Max
Act Effect Green (s)	10.5	69.0	46.5	46.5
Actuated g/C Ratio	0.15	1.00	0.67	0.67
v/c Ratio	0.58	0.23	0.24	0.23
Control Delay	31.4	0.3	7.5	1.2
Queue Delay	0.0	0.0	0.0	0.0
Total Delay	31.4	0.3	7.5	1.2
LOS	C	A	A	A
Approach Delay	14.4		7.5	1.2
Approach LOS	B		A	A

Intersection Summary

Cycle Length: 69
 Actuated Cycle Length: 69
 Offset: 49 (71%), Referenced to phase 2:NBT and 6:SBT, Start of Green
 Natural Cycle: 60
 Control Type: Actuated-Coordinated
 Maximum v/c Ratio: 0.58
 Intersection Signal Delay: 8.1
 Intersection Capacity Utilization 40.9%
 Analysis Period (min) 15
 Intersection LOS: A
 ICU Level of Service A

Splits and Phases: 6: Voyager Pkwy & Powers Blvd Off-Ramp

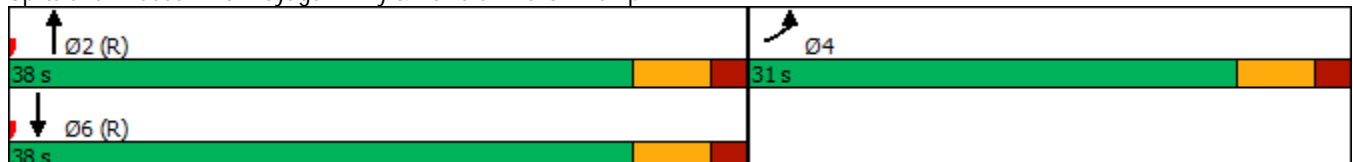

HCM 6th Signalized Intersection Summary
6: Voyager Pkwy & Powers Blvd Off-Ramp

2024 Background PM

09/06/2022



Movement	EBL	EBR	NBL	NBT	SBT	SBR
Lane Configurations	↶↶	↷		↶↶↶	↶↶	
Traffic Volume (veh/h)	288	349	0	787	520	0
Future Volume (veh/h)	288	349	0	787	520	0
Initial Q (Qb), veh	0	0	0	0	0	0
Ped-Bike Adj(A_pbT)	1.00	1.00	1.00			1.00
Parking Bus, Adj	1.00	1.00	1.00	1.00	1.00	1.00
Work Zone On Approach	No			No	No	
Adj Sat Flow, veh/h/ln	1870	1870	0	1870	1870	0
Adj Flow Rate, veh/h	303	0	0	828	547	0
Peak Hour Factor	0.95	0.95	0.95	0.95	0.95	0.95
Percent Heavy Veh, %	2	2	0	2	2	0
Cap, veh/h	417		0	3602	2507	0
Arrive On Green	0.12	0.00	0.00	0.94	0.23	0.00
Sat Flow, veh/h	3456	1585	0	5443	3741	0
Grp Volume(v), veh/h	303	0	0	828	547	0
Grp Sat Flow(s),veh/h/ln	1728	1585	0	1702	1777	0
Q Serve(g_s), s	5.8	0.0	0.0	0.9	8.6	0.0
Cycle Q Clear(g_c), s	5.8	0.0	0.0	0.9	8.6	0.0
Prop In Lane	1.00	1.00	0.00			0.00
Lane Grp Cap(c), veh/h	417		0	3602	2507	0
V/C Ratio(X)	0.73		0.00	0.23	0.22	0.00
Avail Cap(c_a), veh/h	1252		0	3602	2507	0
HCM Platoon Ratio	1.00	1.00	1.00	1.33	0.33	1.00
Upstream Filter(l)	1.00	0.00	0.00	0.95	0.97	0.00
Uniform Delay (d), s/veh	29.2	0.0	0.0	0.7	11.1	0.0
Incr Delay (d2), s/veh	0.9	0.0	0.0	0.1	0.2	0.0
Initial Q Delay(d3),s/veh	0.0	0.0	0.0	0.0	0.0	0.0
%ile BackOfQ(50%),veh/ln	2.4	0.0	0.0	0.2	3.4	0.0
Unsig. Movement Delay, s/veh						
LnGrp Delay(d),s/veh	30.2	0.0	0.0	0.8	11.3	0.0
LnGrp LOS	C		A	A	B	A
Approach Vol, veh/h	303	A		828	547	
Approach Delay, s/veh	30.2			0.8	11.3	
Approach LOS	C			A	B	
Timer - Assigned Phs		2		4		6
Phs Duration (G+Y+Rc), s		54.7		14.3		54.7
Change Period (Y+Rc), s		6.0		6.0		6.0
Max Green Setting (Gmax), s		32.0		25.0		32.0
Max Q Clear Time (g_c+I1), s		2.9		7.8		10.6
Green Ext Time (p_c), s		4.3		0.5		2.5

Intersection Summary

HCM 6th Ctrl Delay	9.5
HCM 6th LOS	A

Notes

Unsignalized Delay for [EBR] is excluded from calculations of the approach delay and intersection delay.

Timings
6: Voyager Pkwy & Powers Blvd Off-Ramp

2024 Total AM
09/06/2022



Lane Group	EBL	EBR	NBT	SBT
Lane Configurations	↖↖	↗	↑↑↑	↑↑
Traffic Volume (vph)	122	468	780	628
Future Volume (vph)	122	468	780	628
Turn Type	Prot	Free	NA	NA
Protected Phases	4		2	6
Permitted Phases		Free		
Detector Phase	4		2	6
Switch Phase				
Minimum Initial (s)	4.0		4.0	4.0
Minimum Split (s)	24.0		24.0	33.0
Total Split (s)	31.0		38.0	38.0
Total Split (%)	44.9%		55.1%	55.1%
Yellow Time (s)	4.0		4.0	4.0
All-Red Time (s)	2.0		2.0	2.0
Lost Time Adjust (s)	0.0		0.0	0.0
Total Lost Time (s)	6.0		6.0	6.0
Lead/Lag				
Lead-Lag Optimize?				
Recall Mode	None		C-Max	C-Max
Act Effect Green (s)	7.1	69.0	53.3	53.3
Actuated g/C Ratio	0.10	1.00	0.77	0.77
v/c Ratio	0.38	0.32	0.22	0.25
Control Delay	31.5	0.5	4.9	1.3
Queue Delay	0.0	0.0	0.0	0.0
Total Delay	31.5	0.5	4.9	1.3
LOS	C	A	A	A
Approach Delay	7.0		4.9	1.3
Approach LOS	A		A	A

Intersection Summary

Cycle Length: 69
 Actuated Cycle Length: 69
 Offset: 49 (71%), Referenced to phase 2:NBT and 6:SBT, Start of Green
 Natural Cycle: 60
 Control Type: Actuated-Coordinated
 Maximum v/c Ratio: 0.38
 Intersection Signal Delay: 4.3
 Intersection Capacity Utilization 45.3%
 Analysis Period (min) 15
 Intersection LOS: A
 ICU Level of Service A

Splits and Phases: 6: Voyager Pkwy & Powers Blvd Off-Ramp

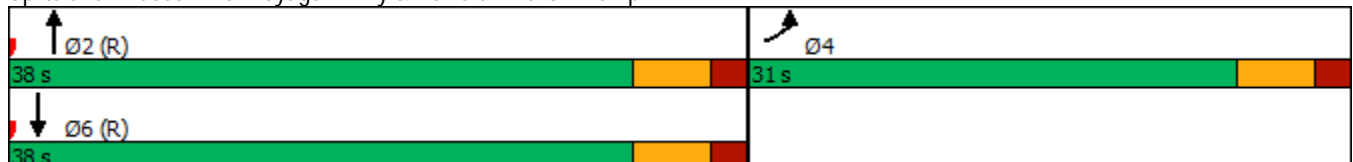

HCM 6th Signalized Intersection Summary
6: Voyager Pkwy & Powers Blvd Off-Ramp

2024 Total AM
09/06/2022



Movement	EBL	EBR	NBL	NBT	SBT	SBR
Lane Configurations	↶↶	↷		↶↶↶	↶↶	
Traffic Volume (veh/h)	122	468	0	780	628	0
Future Volume (veh/h)	122	468	0	780	628	0
Initial Q (Qb), veh	0	0	0	0	0	0
Ped-Bike Adj(A_pbT)	1.00	1.00	1.00			1.00
Parking Bus, Adj	1.00	1.00	1.00	1.00	1.00	1.00
Work Zone On Approach	No			No	No	
Adj Sat Flow, veh/h/ln	1870	1870	0	1870	1870	0
Adj Flow Rate, veh/h	133	0	0	848	683	0
Peak Hour Factor	0.92	0.92	0.92	0.92	0.92	0.92
Percent Heavy Veh, %	2	2	0	2	2	0
Cap, veh/h	221		0	3891	2708	0
Arrive On Green	0.06	0.00	0.00	1.00	0.25	0.00
Sat Flow, veh/h	3456	1585	0	5443	3741	0
Grp Volume(v), veh/h	133	0	0	848	683	0
Grp Sat Flow(s),veh/h/ln	1728	1585	0	1702	1777	0
Q Serve(g_s), s	2.6	0.0	0.0	0.0	10.6	0.0
Cycle Q Clear(g_c), s	2.6	0.0	0.0	0.0	10.6	0.0
Prop In Lane	1.00	1.00	0.00			0.00
Lane Grp Cap(c), veh/h	221		0	3891	2708	0
V/C Ratio(X)	0.60		0.00	0.22	0.25	0.00
Avail Cap(c_a), veh/h	1252		0	3891	2708	0
HCM Platoon Ratio	1.00	1.00	1.00	2.00	0.33	1.00
Upstream Filter(I)	1.00	0.00	0.00	0.97	0.95	0.00
Uniform Delay (d), s/veh	31.4	0.0	0.0	0.0	10.1	0.0
Incr Delay (d2), s/veh	1.0	0.0	0.0	0.1	0.2	0.0
Initial Q Delay(d3),s/veh	0.0	0.0	0.0	0.0	0.0	0.0
%ile BackOfQ(50%),veh/ln	1.1	0.0	0.0	0.0	4.7	0.0
Unsig. Movement Delay, s/veh						
LnGrp Delay(d),s/veh	32.4	0.0	0.0	0.1	10.3	0.0
LnGrp LOS	C		A	A	B	A
Approach Vol, veh/h	133	A		848	683	
Approach Delay, s/veh	32.4			0.1	10.3	
Approach LOS	C			A	B	
Timer - Assigned Phs		2		4		6
Phs Duration (G+Y+Rc), s		58.6		10.4		58.6
Change Period (Y+Rc), s		6.0		6.0		6.0
Max Green Setting (Gmax), s		32.0		25.0		32.0
Max Q Clear Time (g_c+I1), s		2.0		4.6		12.6
Green Ext Time (p_c), s		4.5		0.2		3.1

Intersection Summary

HCM 6th Ctrl Delay			6.9			
HCM 6th LOS			A			

Notes

Unsignalized Delay for [EBR] is excluded from calculations of the approach delay and intersection delay.

Timings
6: Voyager Pkwy & Powers Blvd Off-Ramp

2024 Total PM
09/06/2022



Lane Group	EBL	EBR	NBT	SBT
Lane Configurations	↖↖	↗	↑↑↑	↑↑
Traffic Volume (vph)	308	349	792	524
Future Volume (vph)	308	349	792	524
Turn Type	Prot	Perm	NA	NA
Protected Phases	4		2	6
Permitted Phases		4		
Detector Phase	4	4	2	6
Switch Phase				
Minimum Initial (s)	4.0	4.0	4.0	4.0
Minimum Split (s)	24.0	24.0	24.0	33.0
Total Split (s)	31.0	31.0	38.0	38.0
Total Split (%)	44.9%	44.9%	55.1%	55.1%
Yellow Time (s)	4.0	4.0	4.0	4.0
All-Red Time (s)	2.0	2.0	2.0	2.0
Lost Time Adjust (s)	0.0	0.0	0.0	0.0
Total Lost Time (s)	6.0	6.0	6.0	6.0
Lead/Lag				
Lead-Lag Optimize?				
Recall Mode	None	None	C-Max	C-Max
Act Effect Green (s)	13.0	13.0	44.0	44.0
Actuated g/C Ratio	0.19	0.19	0.64	0.64
v/c Ratio	0.50	0.76	0.26	0.24
Control Delay	26.8	20.0	9.5	1.3
Queue Delay	0.0	0.0	0.0	0.0
Total Delay	26.9	20.0	9.5	1.3
LOS	C	C	A	A
Approach Delay	23.2		9.5	1.3
Approach LOS	C		A	A

Intersection Summary

Cycle Length: 69
 Actuated Cycle Length: 69
 Offset: 49 (71%), Referenced to phase 2:NBT and 6:SBT, Start of Green
 Natural Cycle: 60
 Control Type: Actuated-Coordinated
 Maximum v/c Ratio: 0.76
 Intersection Signal Delay: 11.9
 Intersection Capacity Utilization 46.1%
 Analysis Period (min) 15
 Intersection LOS: B
 ICU Level of Service A

Splits and Phases: 6: Voyager Pkwy & Powers Blvd Off-Ramp

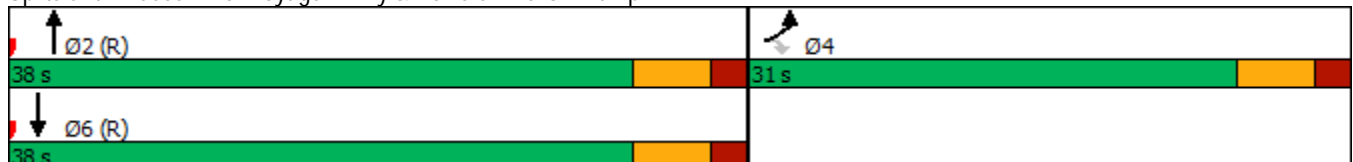

HCM 6th Signalized Intersection Summary
6: Voyager Pkwy & Powers Blvd Off-Ramp

2024 Total PM
09/06/2022



Movement	EBL	EBR	NBL	NBT	SBT	SBR
Lane Configurations	↶↶	↷		↶↶↶	↶↶	
Traffic Volume (veh/h)	308	349	0	792	524	0
Future Volume (veh/h)	308	349	0	792	524	0
Initial Q (Qb), veh	0	0	0	0	0	0
Ped-Bike Adj(A_pbT)	1.00	1.00	1.00			1.00
Parking Bus, Adj	1.00	1.00	1.00	1.00	1.00	1.00
Work Zone On Approach	No			No	No	
Adj Sat Flow, veh/h/ln	1870	1870	0	1870	1870	0
Adj Flow Rate, veh/h	324	0	0	834	552	0
Peak Hour Factor	0.95	0.95	0.95	0.95	0.95	0.95
Percent Heavy Veh, %	2	2	0	2	2	0
Cap, veh/h	439		0	3569	2484	0
Arrive On Green	0.13	0.00	0.00	0.47	0.23	0.00
Sat Flow, veh/h	3456	1585	0	5443	3741	0
Grp Volume(v), veh/h	324	0	0	834	552	0
Grp Sat Flow(s),veh/h/ln	1728	1585	0	1702	1777	0
Q Serve(g_s), s	6.2	0.0	0.0	6.7	8.7	0.0
Cycle Q Clear(g_c), s	6.2	0.0	0.0	6.7	8.7	0.0
Prop In Lane	1.00	1.00	0.00			0.00
Lane Grp Cap(c), veh/h	439		0	3569	2484	0
V/C Ratio(X)	0.74		0.00	0.23	0.22	0.00
Avail Cap(c_a), veh/h	1252		0	3569	2484	0
HCM Platoon Ratio	1.00	1.00	1.00	0.67	0.33	1.00
Upstream Filter(l)	1.00	0.00	0.00	0.95	0.97	0.00
Uniform Delay (d), s/veh	29.0	0.0	0.0	7.3	11.3	0.0
Incr Delay (d2), s/veh	0.9	0.0	0.0	0.1	0.2	0.0
Initial Q Delay(d3),s/veh	0.0	0.0	0.0	0.0	0.0	0.0
%ile BackOfQ(50%),veh/ln	2.5	0.0	0.0	2.0	3.4	0.0
Unsig. Movement Delay, s/veh						
LnGrp Delay(d),s/veh	29.9	0.0	0.0	7.5	11.5	0.0
LnGrp LOS	C		A	A	B	A
Approach Vol, veh/h	324	A		834	552	
Approach Delay, s/veh	29.9			7.5	11.5	
Approach LOS	C			A	B	
Timer - Assigned Phs		2		4		6
Phs Duration (G+Y+Rc), s		54.2		14.8		54.2
Change Period (Y+Rc), s		6.0		6.0		6.0
Max Green Setting (Gmax), s		32.0		25.0		32.0
Max Q Clear Time (g_c+l1), s		8.7		8.2		10.7
Green Ext Time (p_c), s		4.2		0.6		2.5

Intersection Summary

HCM 6th Ctrl Delay	13.0
HCM 6th LOS	B

Notes

Unsignalized Delay for [EBR] is excluded from calculations of the approach delay and intersection delay.

Timings
6: Voyager Pkwy & Powers Blvd Off-Ramp



Lane Group	EBL	EBR	NBT	SBT
Lane Configurations	↖↖	↗	↑↑↑	↑↑
Traffic Volume (vph)	212	851	1414	1131
Future Volume (vph)	212	851	1414	1131
Turn Type	Prot	Free	NA	NA
Protected Phases	4		2	6
Permitted Phases		Free		
Detector Phase	4		2	6
Switch Phase				
Minimum Initial (s)	4.0		4.0	4.0
Minimum Split (s)	24.0		24.0	33.0
Total Split (s)	31.0		38.0	38.0
Total Split (%)	44.9%		55.1%	55.1%
Yellow Time (s)	4.0		4.0	4.0
All-Red Time (s)	2.0		2.0	2.0
Lost Time Adjust (s)	0.0		0.0	0.0
Total Lost Time (s)	6.0		6.0	6.0
Lead/Lag				
Lead-Lag Optimize?				
Recall Mode	None		C-Max	C-Max
Act Effect Green (s)	9.0	69.0	48.0	48.0
Actuated g/C Ratio	0.13	1.00	0.70	0.70
v/c Ratio	0.51	0.58	0.43	0.50
Control Delay	31.6	1.6	9.4	4.4
Queue Delay	0.1	0.1	0.1	0.0
Total Delay	31.7	1.6	9.5	4.5
LOS	C	A	A	A
Approach Delay	7.6		9.5	4.5
Approach LOS	A		A	A

Intersection Summary

Cycle Length: 69
 Actuated Cycle Length: 69
 Offset: 49 (71%), Referenced to phase 2:NBT and 6:SBT, Start of Green
 Natural Cycle: 60
 Control Type: Actuated-Coordinated
 Maximum v/c Ratio: 0.58
 Intersection Signal Delay: 7.4
 Intersection LOS: A
 Intersection Capacity Utilization 74.5%
 ICU Level of Service D
 Analysis Period (min) 15

Splits and Phases: 6: Voyager Pkwy & Powers Blvd Off-Ramp



HCM 6th Signalized Intersection Summary
6: Voyager Pkwy & Powers Blvd Off-Ramp

2045 Background AM
09/06/2022



Movement	EBL	EBR	NBL	NBT	SBT	SBR
Lane Configurations	↶↶	↷		↶↶↶	↶↶	
Traffic Volume (veh/h)	212	851	0	1414	1131	0
Future Volume (veh/h)	212	851	0	1414	1131	0
Initial Q (Qb), veh	0	0	0	0	0	0
Ped-Bike Adj(A_pbT)	1.00	1.00	1.00			1.00
Parking Bus, Adj	1.00	1.00	1.00	1.00	1.00	1.00
Work Zone On Approach	No			No	No	
Adj Sat Flow, veh/h/ln	1870	1870	0	1870	1870	0
Adj Flow Rate, veh/h	230	0	0	1537	1229	0
Peak Hour Factor	0.92	0.92	0.92	0.92	0.92	0.92
Percent Heavy Veh, %	2	2	0	2	2	0
Cap, veh/h	338		0	3719	2588	0
Arrive On Green	0.10	0.00	0.00	1.00	0.49	0.00
Sat Flow, veh/h	3456	1585	0	5443	3741	0
Grp Volume(v), veh/h	230	0	0	1537	1229	0
Grp Sat Flow(s),veh/h/ln	1728	1585	0	1702	1777	0
Q Serve(g_s), s	4.4	0.0	0.0	0.0	15.9	0.0
Cycle Q Clear(g_c), s	4.4	0.0	0.0	0.0	15.9	0.0
Prop In Lane	1.00	1.00	0.00			0.00
Lane Grp Cap(c), veh/h	338		0	3719	2588	0
V/C Ratio(X)	0.68		0.00	0.41	0.47	0.00
Avail Cap(c_a), veh/h	1252		0	3719	2588	0
HCM Platoon Ratio	1.00	1.00	1.00	2.00	0.67	1.00
Upstream Filter(I)	1.00	0.00	0.00	0.81	0.56	0.00
Uniform Delay (d), s/veh	30.1	0.0	0.0	0.0	8.9	0.0
Incr Delay (d2), s/veh	0.9	0.0	0.0	0.3	0.4	0.0
Initial Q Delay(d3),s/veh	0.0	0.0	0.0	0.0	0.0	0.0
%ile BackOfQ(50%),veh/ln	1.8	0.0	0.0	0.1	6.4	0.0
Unsig. Movement Delay, s/veh						
LnGrp Delay(d),s/veh	31.0	0.0	0.0	0.3	9.2	0.0
LnGrp LOS	C		A	A	A	A
Approach Vol, veh/h	230	A		1537	1229	
Approach Delay, s/veh	31.0			0.3	9.2	
Approach LOS	C			A	A	
Timer - Assigned Phs		2		4		6
Phs Duration (G+Y+Rc), s		56.3		12.7		56.3
Change Period (Y+Rc), s		6.0		6.0		6.0
Max Green Setting (Gmax), s		32.0		25.0		32.0
Max Q Clear Time (g_c+I1), s		2.0		6.4		17.9
Green Ext Time (p_c), s		9.7		0.4		5.6

Intersection Summary

HCM 6th Ctrl Delay			6.3			
HCM 6th LOS			A			

Notes

Unsignalized Delay for [EBR] is excluded from calculations of the approach delay and intersection delay.

Timings
6: Voyager Pkwy & Powers Blvd Off-Ramp



Lane Group	EBL	EBR	NBT	SBT
Lane Configurations	↖↖	↗	↑↑↑	↑↑
Traffic Volume (vph)	525	636	1430	942
Future Volume (vph)	525	636	1430	942
Turn Type	Prot	Free	NA	NA
Protected Phases	4		2	6
Permitted Phases		Free		
Detector Phase	4		2	6
Switch Phase				
Minimum Initial (s)	4.0		4.0	4.0
Minimum Split (s)	24.0		24.0	33.0
Total Split (s)	31.0		38.0	38.0
Total Split (%)	44.9%		55.1%	55.1%
Yellow Time (s)	4.0		4.0	4.0
All-Red Time (s)	2.0		2.0	2.0
Lost Time Adjust (s)	0.0		0.0	0.0
Total Lost Time (s)	6.0		6.0	6.0
Lead/Lag				
Lead-Lag Optimize?				
Recall Mode	None		C-Max	C-Max
Act Effect Green (s)	15.6	69.0	41.4	41.4
Actuated g/C Ratio	0.23	1.00	0.60	0.60
v/c Ratio	0.71	0.42	0.49	0.47
Control Delay	29.7	0.8	12.6	5.3
Queue Delay	0.2	0.0	0.1	0.0
Total Delay	29.9	0.8	12.7	5.3
LOS	C	A	B	A
Approach Delay	14.0		12.7	5.3
Approach LOS	B		B	A

Intersection Summary

Cycle Length: 69
 Actuated Cycle Length: 69
 Offset: 49 (71%), Referenced to phase 2:NBT and 6:SBT, Start of Green
 Natural Cycle: 60
 Control Type: Actuated-Coordinated
 Maximum v/c Ratio: 0.71
 Intersection Signal Delay: 11.1
 Intersection LOS: B
 Intersection Capacity Utilization 85.5%
 ICU Level of Service E
 Analysis Period (min) 15

Splits and Phases: 6: Voyager Pkwy & Powers Blvd Off-Ramp

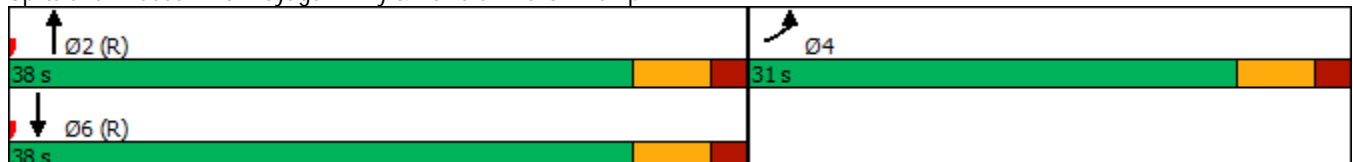

HCM 6th Signalized Intersection Summary
6: Voyager Pkwy & Powers Blvd Off-Ramp

2045 Background PM
09/06/2022



Movement	EBL	EBR	NBL	NBT	SBT	SBR
Lane Configurations	↶↶	↷		↶↶↶	↶↶	
Traffic Volume (veh/h)	525	636	0	1430	942	0
Future Volume (veh/h)	525	636	0	1430	942	0
Initial Q (Qb), veh	0	0	0	0	0	0
Ped-Bike Adj(A_pbT)	1.00	1.00	1.00			1.00
Parking Bus, Adj	1.00	1.00	1.00	1.00	1.00	1.00
Work Zone On Approach	No			No	No	
Adj Sat Flow, veh/h/ln	1870	1870	0	1870	1870	0
Adj Flow Rate, veh/h	553	0	0	1505	992	0
Peak Hour Factor	0.95	0.95	0.95	0.95	0.95	0.95
Percent Heavy Veh, %	2	2	0	2	2	0
Cap, veh/h	678		0	3217	2239	0
Arrive On Green	0.20	0.00	0.00	0.84	0.21	0.00
Sat Flow, veh/h	3456	1585	0	5443	3741	0
Grp Volume(v), veh/h	553	0	0	1505	992	0
Grp Sat Flow(s),veh/h/ln	1728	1585	0	1702	1777	0
Q Serve(g_s), s	10.6	0.0	0.0	5.4	16.8	0.0
Cycle Q Clear(g_c), s	10.6	0.0	0.0	5.4	16.8	0.0
Prop In Lane	1.00	1.00	0.00			0.00
Lane Grp Cap(c), veh/h	678		0	3217	2239	0
V/C Ratio(X)	0.82		0.00	0.47	0.44	0.00
Avail Cap(c_a), veh/h	1252		0	3217	2239	0
HCM Platoon Ratio	1.00	1.00	1.00	1.33	0.33	1.00
Upstream Filter(l)	1.00	0.00	0.00	0.74	0.74	0.00
Uniform Delay (d), s/veh	26.5	0.0	0.0	2.5	16.8	0.0
Incr Delay (d2), s/veh	0.9	0.0	0.0	0.4	0.5	0.0
Initial Q Delay(d3),s/veh	0.0	0.0	0.0	0.0	0.0	0.0
%ile BackOfQ(50%),veh/ln	4.2	0.0	0.0	1.2	7.9	0.0
Unsig. Movement Delay, s/veh						
LnGrp Delay(d),s/veh	27.5	0.0	0.0	2.9	17.2	0.0
LnGrp LOS	C		A	A	B	A
Approach Vol, veh/h	553	A		1505	992	
Approach Delay, s/veh	27.5			2.9	17.2	
Approach LOS	C			A	B	
Timer - Assigned Phs		2		4		6
Phs Duration (G+Y+Rc), s		49.5		19.5		49.5
Change Period (Y+Rc), s		6.0		6.0		6.0
Max Green Setting (Gmax), s		32.0		25.0		32.0
Max Q Clear Time (g_c+l1), s		7.4		12.6		18.8
Green Ext Time (p_c), s		8.9		1.0		4.2
Intersection Summary						
HCM 6th Ctrl Delay			12.0			
HCM 6th LOS			B			
Notes						
Unsignalized Delay for [EBR] is excluded from calculations of the approach delay and intersection delay.						

Timings
6: Voyager Pkwy & Powers Blvd Off-Ramp

2045 Total AM

09/06/2022



Lane Group	EBL	EBR	NBT	SBT
Lane Configurations	↖↖	↗	↑↑↑	↑↑
Traffic Volume (vph)	218	851	1416	1136
Future Volume (vph)	218	851	1416	1136
Turn Type	Prot	Free	NA	NA
Protected Phases	4		2	6
Permitted Phases		Free		
Detector Phase	4		2	6
Switch Phase				
Minimum Initial (s)	4.0		4.0	4.0
Minimum Split (s)	24.0		24.0	33.0
Total Split (s)	31.0		38.0	38.0
Total Split (%)	44.9%		55.1%	55.1%
Yellow Time (s)	4.0		4.0	4.0
All-Red Time (s)	2.0		2.0	2.0
Lost Time Adjust (s)	0.0		0.0	0.0
Total Lost Time (s)	6.0		6.0	6.0
Lead/Lag				
Lead-Lag Optimize?				
Recall Mode	None		C-Max	C-Max
Act Effect Green (s)	9.2	69.0	47.8	47.8
Actuated g/C Ratio	0.13	1.00	0.69	0.69
v/c Ratio	0.52	0.58	0.44	0.50
Control Delay	31.6	1.6	9.5	4.3
Queue Delay	0.1	0.1	0.1	0.0
Total Delay	31.7	1.6	9.7	4.3
LOS	C	A	A	A
Approach Delay	7.8		9.7	4.3
Approach LOS	A		A	A

Intersection Summary

Cycle Length: 69
 Actuated Cycle Length: 69
 Offset: 49 (71%), Referenced to phase 2:NBT and 6:SBT, Start of Green
 Natural Cycle: 60
 Control Type: Actuated-Coordinated
 Maximum v/c Ratio: 0.58
 Intersection Signal Delay: 7.4
 Intersection LOS: A
 Intersection Capacity Utilization 74.6%
 ICU Level of Service D
 Analysis Period (min) 15

Splits and Phases: 6: Voyager Pkwy & Powers Blvd Off-Ramp

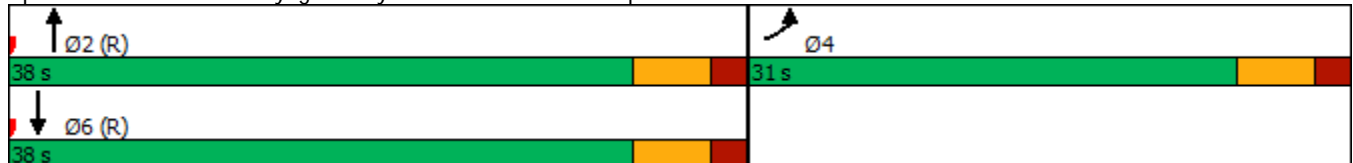

HCM 6th Signalized Intersection Summary
6: Voyager Pkwy & Powers Blvd Off-Ramp

2045 Total AM
09/06/2022



Movement	EBL	EBR	NBL	NBT	SBT	SBR
Lane Configurations	↔↔	↔		↑↑↑	↑↑	
Traffic Volume (veh/h)	218	851	0	1416	1136	0
Future Volume (veh/h)	218	851	0	1416	1136	0
Initial Q (Qb), veh	0	0	0	0	0	0
Ped-Bike Adj(A_pbT)	1.00	1.00	1.00			1.00
Parking Bus, Adj	1.00	1.00	1.00	1.00	1.00	1.00
Work Zone On Approach	No			No	No	
Adj Sat Flow, veh/h/ln	1870	1870	0	1870	1870	0
Adj Flow Rate, veh/h	237	0	0	1539	1235	0
Peak Hour Factor	0.92	0.92	0.92	0.92	0.92	0.92
Percent Heavy Veh, %	2	2	0	2	2	0
Cap, veh/h	345		0	3708	2580	0
Arrive On Green	0.10	0.00	0.00	1.00	0.49	0.00
Sat Flow, veh/h	3456	1585	0	5443	3741	0
Grp Volume(v), veh/h	237	0	0	1539	1235	0
Grp Sat Flow(s),veh/h/ln	1728	1585	0	1702	1777	0
Q Serve(g_s), s	4.6	0.0	0.0	0.0	16.1	0.0
Cycle Q Clear(g_c), s	4.6	0.0	0.0	0.0	16.1	0.0
Prop In Lane	1.00	1.00	0.00			0.00
Lane Grp Cap(c), veh/h	345		0	3708	2580	0
V/C Ratio(X)	0.69		0.00	0.42	0.48	0.00
Avail Cap(c_a), veh/h	1252		0	3708	2580	0
HCM Platoon Ratio	1.00	1.00	1.00	2.00	0.67	1.00
Upstream Filter(l)	1.00	0.00	0.00	0.81	0.55	0.00
Uniform Delay (d), s/veh	30.0	0.0	0.0	0.0	9.0	0.0
Incr Delay (d2), s/veh	0.9	0.0	0.0	0.3	0.4	0.0
Initial Q Delay(d3),s/veh	0.0	0.0	0.0	0.0	0.0	0.0
%ile BackOfQ(50%),veh/ln	1.9	0.0	0.0	0.1	6.5	0.0
Unsig. Movement Delay, s/veh						
LnGrp Delay(d),s/veh	30.9	0.0	0.0	0.3	9.3	0.0
LnGrp LOS	C		A	A	A	A
Approach Vol, veh/h	237	A		1539	1235	
Approach Delay, s/veh	30.9			0.3	9.3	
Approach LOS	C			A	A	
Timer - Assigned Phs		2		4		6
Phs Duration (G+Y+Rc), s		56.1		12.9		56.1
Change Period (Y+Rc), s		6.0		6.0		6.0
Max Green Setting (Gmax), s		32.0		25.0		32.0
Max Q Clear Time (g_c+l1), s		2.0		6.6		18.1
Green Ext Time (p_c), s		9.7		0.4		5.6
Intersection Summary						
HCM 6th Ctrl Delay			6.4			
HCM 6th LOS			A			
Notes						
Unsignalized Delay for [EBR] is excluded from calculations of the approach delay and intersection delay.						

Timings
6: Voyager Pkwy & Powers Blvd Off-Ramp

2045 Total PM
09/06/2022



Lane Group	EBL	EBR	NBT	SBT
Lane Configurations	↖↖	↗	↑↑↑	↑↑
Traffic Volume (vph)	545	636	1435	946
Future Volume (vph)	545	636	1435	946
Turn Type	Prot	Free	NA	NA
Protected Phases	4		2	6
Permitted Phases		Free		
Detector Phase	4		2	6
Switch Phase				
Minimum Initial (s)	4.0		4.0	4.0
Minimum Split (s)	24.0		24.0	33.0
Total Split (s)	31.0		38.0	38.0
Total Split (%)	44.9%		55.1%	55.1%
Yellow Time (s)	4.0		4.0	4.0
All-Red Time (s)	2.0		2.0	2.0
Lost Time Adjust (s)	0.0		0.0	0.0
Total Lost Time (s)	6.0		6.0	6.0
Lead/Lag				
Lead-Lag Optimize?				
Recall Mode	None		C-Max	C-Max
Act Effect Green (s)	16.0	69.0	41.0	41.0
Actuated g/C Ratio	0.23	1.00	0.59	0.59
v/c Ratio	0.72	0.42	0.50	0.47
Control Delay	29.6	0.8	13.0	5.9
Queue Delay	0.2	0.0	0.1	0.0
Total Delay	29.9	0.8	13.1	5.9
LOS	C	A	B	A
Approach Delay	14.2		13.1	5.9
Approach LOS	B		B	A

Intersection Summary

Cycle Length: 69
 Actuated Cycle Length: 69
 Offset: 49 (71%), Referenced to phase 2:NBT and 6:SBT, Start of Green
 Natural Cycle: 60
 Control Type: Actuated-Coordinated
 Maximum v/c Ratio: 0.72
 Intersection Signal Delay: 11.6
 Intersection Capacity Utilization 86.2%
 Analysis Period (min) 15
 Intersection LOS: B
 ICU Level of Service E

Splits and Phases: 6: Voyager Pkwy & Powers Blvd Off-Ramp

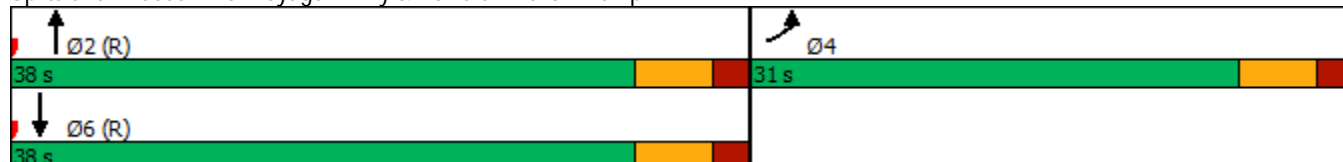

HCM 6th Signalized Intersection Summary
6: Voyager Pkwy & Powers Blvd Off-Ramp

2045 Total PM
09/06/2022



Movement	EBL	EBR	NBL	NBT	SBT	SBR
Lane Configurations	↶↶	↷		↶↶↶	↶↶	
Traffic Volume (veh/h)	545	636	0	1435	946	0
Future Volume (veh/h)	545	636	0	1435	946	0
Initial Q (Qb), veh	0	0	0	0	0	0
Ped-Bike Adj(A_pbT)	1.00	1.00	1.00			1.00
Parking Bus, Adj	1.00	1.00	1.00	1.00	1.00	1.00
Work Zone On Approach	No			No	No	
Adj Sat Flow, veh/h/ln	1870	1870	0	1870	1870	0
Adj Flow Rate, veh/h	574	0	0	1511	996	0
Peak Hour Factor	0.95	0.95	0.95	0.95	0.95	0.95
Percent Heavy Veh, %	2	2	0	2	2	0
Cap, veh/h	699		0	3185	2217	0
Arrive On Green	0.20	0.00	0.00	0.83	0.21	0.00
Sat Flow, veh/h	3456	1585	0	5443	3741	0
Grp Volume(v), veh/h	574	0	0	1511	996	0
Grp Sat Flow(s),veh/h/ln	1728	1585	0	1702	1777	0
Q Serve(g_s), s	11.0	0.0	0.0	5.7	16.9	0.0
Cycle Q Clear(g_c), s	11.0	0.0	0.0	5.7	16.9	0.0
Prop In Lane	1.00	1.00	0.00			0.00
Lane Grp Cap(c), veh/h	699		0	3185	2217	0
V/C Ratio(X)	0.82		0.00	0.47	0.45	0.00
Avail Cap(c_a), veh/h	1252		0	3185	2217	0
HCM Platoon Ratio	1.00	1.00	1.00	1.33	0.33	1.00
Upstream Filter(l)	1.00	0.00	0.00	0.74	0.74	0.00
Uniform Delay (d), s/veh	26.3	0.0	0.0	2.7	17.0	0.0
Incr Delay (d2), s/veh	0.9	0.0	0.0	0.4	0.5	0.0
Initial Q Delay(d3),s/veh	0.0	0.0	0.0	0.0	0.0	0.0
%ile BackOfQ(50%),veh/ln	4.4	0.0	0.0	1.3	8.0	0.0
Unsig. Movement Delay, s/veh						
LnGrp Delay(d),s/veh	27.3	0.0	0.0	3.1	17.5	0.0
LnGrp LOS	C		A	A	B	A
Approach Vol, veh/h	574	A		1511	996	
Approach Delay, s/veh	27.3			3.1	17.5	
Approach LOS	C			A	B	
Timer - Assigned Phs		2		4		6
Phs Duration (G+Y+Rc), s		49.0		20.0		49.0
Change Period (Y+Rc), s		6.0		6.0		6.0
Max Green Setting (Gmax), s		32.0		25.0		32.0
Max Q Clear Time (g_c+l1), s		7.7		13.0		18.9
Green Ext Time (p_c), s		8.9		1.0		4.2
Intersection Summary						
HCM 6th Ctrl Delay			12.3			
HCM 6th LOS			B			

Notes

Unsignalized Delay for [EBR] is excluded from calculations of the approach delay and intersection delay.

Timings
7: Voyager Pkwy & S. Spectrum Loop

2022 Existing AM
09/06/2022

Lane Group	EBL	EBT	EBR	WBL	WBT	WBR	NBL	NBT	NBR	SBL	SBT	SBR
Lane Configurations												
Traffic Volume (vph)	5	7	2	27	3	47	11	670	59	54	940	33
Future Volume (vph)	5	7	2	27	3	47	11	670	59	54	940	33
Turn Type	Perm	NA	Perm	Perm	NA	Perm	Prot	NA	Perm	Prot	NA	Perm
Protected Phases		4			8		5	2		1	6	
Permitted Phases	4		4	8		8			2			6
Detector Phase	4	4	4	8	8	8	5	2	2	1	6	6
Switch Phase												
Minimum Initial (s)	4.0	4.0	4.0	4.0	4.0	4.0	4.0	4.0	4.0	4.0	4.0	4.0
Minimum Split (s)	10.5	10.5	10.5	35.5	35.5	35.5	9.5	37.5	37.5	9.5	49.5	49.5
Total Split (s)	36.0	36.0	36.0	36.0	36.0	36.0	20.0	82.0	82.0	20.0	82.0	82.0
Total Split (%)	26.1%	26.1%	26.1%	26.1%	26.1%	26.1%	14.5%	59.4%	59.4%	14.5%	59.4%	59.4%
Yellow Time (s)	4.5	4.5	4.5	4.5	4.5	4.5	3.0	4.5	4.5	3.0	4.5	4.5
All-Red Time (s)	2.0	2.0	2.0	2.0	2.0	2.0	2.0	2.0	2.0	2.0	2.0	2.0
Lost Time Adjust (s)	0.0	0.0	0.0	0.0	0.0	0.0	0.0	0.0	0.0	0.0	0.0	0.0
Total Lost Time (s)	6.5	6.5	6.5	6.5	6.5	6.5	5.0	6.5	6.5	5.0	6.5	6.5
Lead/Lag							Lead	Lag	Lag	Lead	Lag	Lag
Lead-Lag Optimize?							Yes	Yes	Yes	Yes	Yes	Yes
Recall Mode	None	None	None	None	None	None	None	C-Max	C-Max	None	C-Max	C-Max
Act Effct Green (s)	7.4	7.4	7.4	7.4	7.4	7.4	5.6	109.1	109.1	9.0	116.5	116.5
Actuated g/C Ratio	0.05	0.05	0.05	0.05	0.05	0.05	0.04	0.79	0.79	0.07	0.84	0.84
v/c Ratio	0.07	0.08	0.01	0.39	0.03	0.34	0.17	0.26	0.05	0.51	0.34	0.03
Control Delay	62.0	62.0	0.0	76.9	60.7	14.3	68.7	5.6	1.3	72.5	3.8	1.0
Queue Delay	0.0	0.0	0.0	0.0	0.0	0.0	0.0	0.0	0.0	0.0	0.0	0.0
Total Delay	62.0	62.0	0.0	76.9	60.7	14.3	68.7	5.6	1.3	72.5	3.8	1.0
LOS	E	E	A	E	E	B	E	A	A	E	A	A
Approach Delay		53.7			37.8			6.2			7.4	
Approach LOS		D			D			A			A	

Intersection Summary

Cycle Length: 138
 Actuated Cycle Length: 138
 Offset: 79 (57%), Referenced to phase 2:NBT and 6:SBT, Start of Green
 Natural Cycle: 95
 Control Type: Actuated-Coordinated
 Maximum v/c Ratio: 0.51
 Intersection Signal Delay: 8.5
 Intersection Capacity Utilization 52.5%
 Analysis Period (min) 15
 Intersection LOS: A
 ICU Level of Service A

Splits and Phases: 7: Voyager Pkwy & S. Spectrum Loop



HCM 6th Signalized Intersection Summary
 7: Voyager Pkwy & S. Spectrum Loop

2022 Existing AM
 09/06/2022

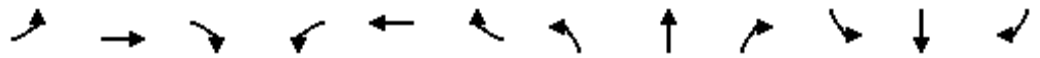

























Movement	EBL	EBT	EBR	WBL	WBT	WBR	NBL	NBT	NBR	SBL	SBT	SBR
Lane Configurations												
Traffic Volume (veh/h)	5	7	2	27	3	47	11	670	59	54	940	33
Future Volume (veh/h)	5	7	2	27	3	47	11	670	59	54	940	33
Initial Q (Qb), veh	0	0	0	0	0	0	0	0	0	0	0	0
Ped-Bike Adj(A_pbT)	1.00		1.00	1.00		1.00	1.00		1.00	1.00		1.00
Parking Bus, Adj	1.00	1.00	1.00	1.00	1.00	1.00	1.00	1.00	1.00	1.00	1.00	1.00
Work Zone On Approach		No			No			No			No	
Adj Sat Flow, veh/h/ln	1870	1870	1870	1870	1870	1870	1870	1870	1870	1870	1870	1870
Adj Flow Rate, veh/h	5	8	2	29	3	51	12	728	64	59	1022	36
Peak Hour Factor	0.92	0.92	0.92	0.92	0.92	0.92	0.92	0.92	0.92	0.92	0.92	0.92
Percent Heavy Veh, %	2	2	2	2	2	2	2	2	2	2	2	2
Cap, veh/h	112	86	73	111	86	73	19	2777	1239	75	2889	1289
Arrive On Green	0.05	0.05	0.05	0.05	0.05	0.05	0.01	0.78	0.78	0.08	1.00	1.00
Sat Flow, veh/h	1350	1870	1585	1405	1870	1585	1781	3554	1585	1781	3554	1585
Grp Volume(v), veh/h	5	8	2	29	3	51	12	728	64	59	1022	36
Grp Sat Flow(s),veh/h/ln	1350	1870	1585	1405	1870	1585	1781	1777	1585	1781	1777	1585
Q Serve(g_s), s	0.5	0.6	0.2	2.8	0.2	4.4	0.9	7.8	1.3	4.5	0.0	0.0
Cycle Q Clear(g_c), s	0.7	0.6	0.2	3.4	0.2	4.4	0.9	7.8	1.3	4.5	0.0	0.0
Prop In Lane	1.00		1.00	1.00		1.00	1.00		1.00	1.00		1.00
Lane Grp Cap(c), veh/h	112	86	73	111	86	73	19	2777	1239	75	2889	1289
V/C Ratio(X)	0.04	0.09	0.03	0.26	0.03	0.70	0.63	0.26	0.05	0.78	0.35	0.03
Avail Cap(c_a), veh/h	339	400	339	347	400	339	194	2777	1239	194	2889	1289
HCM Platoon Ratio	1.00	1.00	1.00	1.00	1.00	1.00	1.00	1.00	1.00	2.00	2.00	2.00
Upstream Filter(l)	1.00	1.00	1.00	1.00	1.00	1.00	1.00	1.00	1.00	0.81	0.81	0.81
Uniform Delay (d), s/veh	63.2	63.1	62.9	64.7	62.9	64.9	68.0	4.1	3.4	62.5	0.0	0.0
Incr Delay (d2), s/veh	0.1	0.2	0.1	0.5	0.1	4.5	12.1	0.2	0.1	5.3	0.3	0.0
Initial Q Delay(d3),s/veh	0.0	0.0	0.0	0.0	0.0	0.0	0.0	0.0	0.0	0.0	0.0	0.0
%ile BackOfQ(50%),veh/ln	0.2	0.3	0.1	1.0	0.1	1.9	0.5	2.6	0.4	2.1	0.1	0.0
Unsig. Movement Delay, s/veh												
LnGrp Delay(d),s/veh	63.3	63.3	62.9	65.2	63.0	69.4	80.1	4.4	3.5	67.9	0.3	0.0
LnGrp LOS	E	E	E	E	E	E	F	A	A	E	A	A
Approach Vol, veh/h		15			83			804			1117	
Approach Delay, s/veh		63.2			67.7			5.4			3.8	
Approach LOS		E			E			A			A	
Timer - Assigned Phs	1	2		4	5	6		8				
Phs Duration (G+Y+Rc), s	10.8	114.3		12.8	6.5	118.7		12.8				
Change Period (Y+Rc), s	5.0	6.5		6.5	5.0	6.5		6.5				
Max Green Setting (Gmax), s	15.0	75.5		29.5	15.0	75.5		29.5				
Max Q Clear Time (g_c+I1), s	6.5	9.8		2.7	2.9	2.0		6.4				
Green Ext Time (p_c), s	0.0	3.9		0.0	0.0	6.0		0.1				

Intersection Summary

HCM 6th Ctrl Delay	7.5
HCM 6th LOS	A

Timings
7: Voyager Pkwy & S. Spectrum Loop

												
Lane Group	EBL	EBT	EBR	WBL	WBT	WBR	NBL	NBT	NBR	SBL	SBT	SBR
Lane Configurations												
Traffic Volume (vph)	34	4	47	51	4	79	44	729	62	45	734	27
Future Volume (vph)	34	4	47	51	4	79	44	729	62	45	734	27
Turn Type	Perm	NA	Perm	Perm	NA	Perm	Prot	NA	Perm	Prot	NA	Perm
Protected Phases		4			8		5	2		1	6	
Permitted Phases	4		4	8		8			2			6
Detector Phase	4	4	4	8	8	8	5	2	2	1	6	6
Switch Phase												
Minimum Initial (s)	4.0	4.0	4.0	4.0	4.0	4.0	4.0	4.0	4.0	4.0	4.0	4.0
Minimum Split (s)	10.5	10.5	10.5	35.5	35.5	35.5	9.5	37.5	37.5	9.5	49.5	49.5
Total Split (s)	36.0	36.0	36.0	36.0	36.0	36.0	20.0	82.0	82.0	20.0	82.0	82.0
Total Split (%)	26.1%	26.1%	26.1%	26.1%	26.1%	26.1%	14.5%	59.4%	59.4%	14.5%	59.4%	59.4%
Yellow Time (s)	4.5	4.5	4.5	4.5	4.5	4.5	3.0	4.5	4.5	3.0	4.5	4.5
All-Red Time (s)	2.0	2.0	2.0	2.0	2.0	2.0	2.0	2.0	2.0	2.0	2.0	2.0
Lost Time Adjust (s)	0.0	0.0	0.0	0.0	0.0	0.0	0.0	0.0	0.0	0.0	0.0	0.0
Total Lost Time (s)	6.5	6.5	6.5	6.5	6.5	6.5	5.0	6.5	6.5	5.0	6.5	6.5
Lead/Lag							Lead	Lag	Lag	Lead	Lag	Lag
Lead-Lag Optimize?							Yes	Yes	Yes	Yes	Yes	Yes
Recall Mode	None	None	None	None	None	None	None	C-Max	C-Max	None	C-Max	C-Max
Act Effect Green (s)	9.8	9.8	9.8	9.8	9.8	9.8	8.1	103.9	103.9	8.2	104.0	104.0
Actuated g/C Ratio	0.07	0.07	0.07	0.07	0.07	0.07	0.06	0.75	0.75	0.06	0.75	0.75
v/c Ratio	0.37	0.03	0.29	0.56	0.03	0.45	0.46	0.30	0.06	0.47	0.30	0.02
Control Delay	70.1	57.2	11.7	81.3	57.2	18.9	76.1	6.7	1.7	78.3	4.4	0.1
Queue Delay	0.0	0.0	0.0	0.0	0.0	0.0	0.0	0.0	0.0	0.0	0.0	0.0
Total Delay	70.1	57.2	11.7	81.3	57.2	18.9	76.1	6.7	1.7	78.3	4.4	0.1
LOS	E	E	B	F	E	B	E	A	A	E	A	A
Approach Delay		37.2			43.7			10.0			8.4	
Approach LOS		D			D			A			A	

Intersection Summary

Cycle Length: 138	
Actuated Cycle Length: 138	
Offset: 79 (57%), Referenced to phase 2:NBT and 6:SBT, Start of Green	
Natural Cycle: 95	
Control Type: Actuated-Coordinated	
Maximum v/c Ratio: 0.56	
Intersection Signal Delay: 12.9	Intersection LOS: B
Intersection Capacity Utilization 48.1%	ICU Level of Service A
Analysis Period (min) 15	

Splits and Phases: 7: Voyager Pkwy & S. Spectrum Loop



HCM 6th Signalized Intersection Summary
 7: Voyager Pkwy & S. Spectrum Loop

2022 Existing PM
 09/06/2022

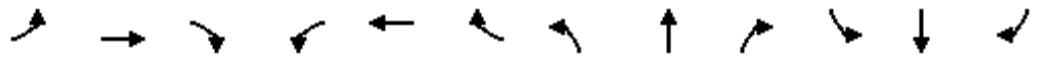

Movement	EBL	EBT	EBR	WBL	WBT	WBR	NBL	NBT	NBR	SBL	SBT	SBR
Lane Configurations												
Traffic Volume (veh/h)	34	4	47	51	4	79	44	729	62	45	734	27
Future Volume (veh/h)	34	4	47	51	4	79	44	729	62	45	734	27
Initial Q (Qb), veh	0	0	0	0	0	0	0	0	0	0	0	0
Ped-Bike Adj(A_pbT)	1.00		1.00	1.00		1.00	1.00		1.00	1.00		1.00
Parking Bus, Adj	1.00	1.00	1.00	1.00	1.00	1.00	1.00	1.00	1.00	1.00	1.00	1.00
Work Zone On Approach		No			No			No			No	
Adj Sat Flow, veh/h/ln	1870	1870	1870	1870	1870	1870	1870	1870	1870	1870	1870	1870
Adj Flow Rate, veh/h	37	4	51	55	4	86	48	792	67	49	798	29
Peak Hour Factor	0.92	0.92	0.92	0.92	0.92	0.92	0.92	0.92	0.92	0.92	0.92	0.92
Percent Heavy Veh, %	2	2	2	2	2	2	2	2	2	2	2	2
Cap, veh/h	140	130	110	143	130	110	62	2718	1212	63	2720	1213
Arrive On Green	0.07	0.07	0.07	0.07	0.07	0.07	0.03	0.76	0.76	0.07	1.00	1.00
Sat Flow, veh/h	1307	1870	1585	1349	1870	1585	1781	3554	1585	1781	3554	1585
Grp Volume(v), veh/h	37	4	51	55	4	86	48	792	67	49	798	29
Grp Sat Flow(s),veh/h/ln	1307	1870	1585	1349	1870	1585	1781	1777	1585	1781	1777	1585
Q Serve(g_s), s	3.8	0.3	4.3	5.5	0.3	7.4	3.7	9.3	1.4	3.7	0.0	0.0
Cycle Q Clear(g_c), s	4.0	0.3	4.3	5.7	0.3	7.4	3.7	9.3	1.4	3.7	0.0	0.0
Prop In Lane	1.00		1.00	1.00		1.00	1.00		1.00	1.00		1.00
Lane Grp Cap(c), veh/h	140	130	110	143	130	110	62	2718	1212	63	2720	1213
V/C Ratio(X)	0.26	0.03	0.46	0.38	0.03	0.78	0.77	0.29	0.06	0.78	0.29	0.02
Avail Cap(c_a), veh/h	329	400	339	338	400	339	194	2718	1212	194	2720	1213
HCM Platoon Ratio	1.00	1.00	1.00	1.00	1.00	1.00	1.00	1.00	1.00	2.00	2.00	2.00
Upstream Filter(l)	1.00	1.00	1.00	1.00	1.00	1.00	1.00	1.00	1.00	0.91	0.91	0.91
Uniform Delay (d), s/veh	61.8	59.9	61.7	62.6	59.9	63.2	66.1	4.9	4.0	63.6	0.0	0.0
Incr Delay (d2), s/veh	0.4	0.0	1.1	0.6	0.0	4.5	7.4	0.3	0.1	6.9	0.2	0.0
Initial Q Delay(d3),s/veh	0.0	0.0	0.0	0.0	0.0	0.0	0.0	0.0	0.0	0.0	0.0	0.0
%ile BackOfQ(50%),veh/ln	1.3	0.1	1.8	1.9	0.1	3.1	1.8	3.2	0.5	1.8	0.1	0.0
Unsig. Movement Delay, s/veh												
LnGrp Delay(d),s/veh	62.1	59.9	62.9	63.2	59.9	67.7	73.5	5.2	4.1	70.5	0.2	0.0
LnGrp LOS	E	E	E	E	E	E	E	A	A	E	A	A
Approach Vol, veh/h		92			145			907			876	
Approach Delay, s/veh		62.5			65.8			8.7			4.2	
Approach LOS		E			E			A			A	
Timer - Assigned Phs	1	2		4	5	6		8				
Phs Duration (G+Y+Rc), s	9.9	112.1		16.1	9.8	112.1		16.1				
Change Period (Y+Rc), s	5.0	6.5		6.5	5.0	6.5		6.5				
Max Green Setting (Gmax), s	15.0	75.5		29.5	15.0	75.5		29.5				
Max Q Clear Time (g_c+I1), s	5.7	11.3		6.3	5.7	2.0		9.4				
Green Ext Time (p_c), s	0.0	4.3		0.1	0.0	4.3		0.2				

Intersection Summary

HCM 6th Ctrl Delay	13.3
HCM 6th LOS	B

Timings
7: Voyager Pkwy & S. Spectrum Loop

Lane Group	EBL	EBT	EBR	WBL	WBT	WBR	NBL	NBT	NBR	SBL	SBT	SBR
Lane Configurations												
Traffic Volume (vph)	10	7	36	29	3	50	23	711	62	57	1005	38
Future Volume (vph)	10	7	36	29	3	50	23	711	62	57	1005	38
Turn Type	Perm	NA	Perm	Perm	NA	Perm	Prot	NA	Perm	Prot	NA	Perm
Protected Phases		4			8		5	2		1	6	
Permitted Phases	4		4	8		8			2			6
Detector Phase	4	4	4	8	8	8	5	2	2	1	6	6
Switch Phase												
Minimum Initial (s)	4.0	4.0	4.0	4.0	4.0	4.0	4.0	4.0	4.0	4.0	4.0	4.0
Minimum Split (s)	10.5	10.5	10.5	35.5	35.5	35.5	9.5	37.5	37.5	9.5	49.5	49.5
Total Split (s)	36.0	36.0	36.0	36.0	36.0	36.0	20.0	82.0	82.0	20.0	82.0	82.0
Total Split (%)	26.1%	26.1%	26.1%	26.1%	26.1%	26.1%	14.5%	59.4%	59.4%	14.5%	59.4%	59.4%
Yellow Time (s)	4.5	4.5	4.5	4.5	4.5	4.5	3.0	4.5	4.5	3.0	4.5	4.5
All-Red Time (s)	2.0	2.0	2.0	2.0	2.0	2.0	2.0	2.0	2.0	2.0	2.0	2.0
Lost Time Adjust (s)	0.0	0.0	0.0	0.0	0.0	0.0	0.0	0.0	0.0	0.0	0.0	0.0
Total Lost Time (s)	6.5	6.5	6.5	6.5	6.5	6.5	5.0	6.5	6.5	5.0	6.5	6.5
Lead/Lag							Lead	Lag	Lag	Lead	Lag	Lag
Lead-Lag Optimize?							Yes	Yes	Yes	Yes	Yes	Yes
Recall Mode	None	None	None	None	None	None	None	C-Max	C-Max	None	C-Max	C-Max
Act Effct Green (s)	7.7	7.7	7.7	7.7	7.7	7.7	6.5	108.7	108.7	9.2	113.3	113.3
Actuated g/C Ratio	0.06	0.06	0.06	0.06	0.06	0.06	0.05	0.79	0.79	0.07	0.82	0.82
v/c Ratio	0.14	0.08	0.26	0.42	0.03	0.36	0.30	0.28	0.05	0.53	0.38	0.03
Control Delay	64.4	61.6	8.0	77.7	60.0	15.8	72.0	5.9	1.5	72.2	5.3	1.5
Queue Delay	0.0	0.0	0.0	0.0	0.0	0.0	0.0	0.0	0.0	0.0	0.0	0.0
Total Delay	64.4	61.6	8.0	77.7	60.0	15.8	72.0	5.9	1.5	72.2	5.3	1.5
LOS	E	E	A	E	E	B	E	A	A	E	A	A
Approach Delay		26.1			39.5			7.5			8.6	
Approach LOS		C			D			A			A	

Intersection Summary

Cycle Length: 138
 Actuated Cycle Length: 138
 Offset: 79 (57%), Referenced to phase 2:NBT and 6:SBT, Start of Green
 Natural Cycle: 95
 Control Type: Actuated-Coordinated
 Maximum v/c Ratio: 0.53
 Intersection Signal Delay: 9.9
 Intersection Capacity Utilization 54.4%
 Analysis Period (min) 15

Intersection LOS: A
 ICU Level of Service A

Splits and Phases: 7: Voyager Pkwy & S. Spectrum Loop

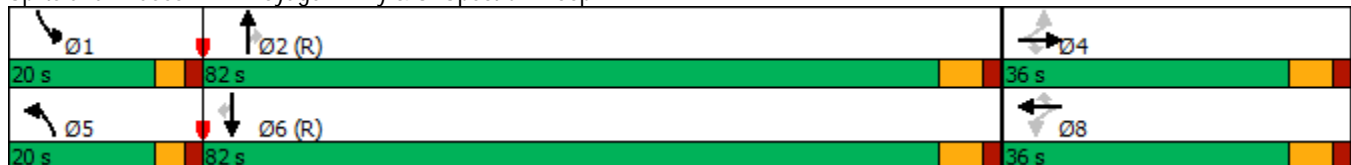

HCM 6th Signalized Intersection Summary
 7: Voyager Pkwy & S. Spectrum Loop

2024 Background AM

09/06/2022

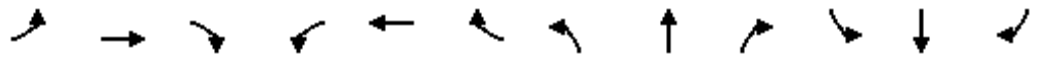

Movement	EBL	EBT	EBR	WBL	WBT	WBR	NBL	NBT	NBR	SBL	SBT	SBR
Lane Configurations												
Traffic Volume (veh/h)	10	7	36	29	3	50	23	711	62	57	1005	38
Future Volume (veh/h)	10	7	36	29	3	50	23	711	62	57	1005	38
Initial Q (Qb), veh	0	0	0	0	0	0	0	0	0	0	0	0
Ped-Bike Adj(A_pbT)	1.00		1.00	1.00		1.00	1.00		1.00	1.00		1.00
Parking Bus, Adj	1.00	1.00	1.00	1.00	1.00	1.00	1.00	1.00	1.00	1.00	1.00	1.00
Work Zone On Approach		No			No			No			No	
Adj Sat Flow, veh/h/ln	1870	1870	1870	1870	1870	1870	1870	1870	1870	1870	1870	1870
Adj Flow Rate, veh/h	11	8	39	32	3	54	25	773	67	62	1092	41
Peak Hour Factor	0.92	0.92	0.92	0.92	0.92	0.92	0.92	0.92	0.92	0.92	0.92	0.92
Percent Heavy Veh, %	2	2	2	2	2	2	2	2	2	2	2	2
Cap, veh/h	116	91	77	113	91	77	32	2760	1231	79	2854	1273
Arrive On Green	0.05	0.05	0.05	0.05	0.05	0.05	0.02	0.78	0.78	0.09	1.00	1.00
Sat Flow, veh/h	1346	1870	1585	1359	1870	1585	1781	3554	1585	1781	3554	1585
Grp Volume(v), veh/h	11	8	39	32	3	54	25	773	67	62	1092	41
Grp Sat Flow(s),veh/h/ln	1346	1870	1585	1359	1870	1585	1781	1777	1585	1781	1777	1585
Q Serve(g_s), s	1.1	0.6	3.3	3.2	0.2	4.6	1.9	8.6	1.4	4.7	0.0	0.0
Cycle Q Clear(g_c), s	1.3	0.6	3.3	3.7	0.2	4.6	1.9	8.6	1.4	4.7	0.0	0.0
Prop In Lane	1.00		1.00	1.00		1.00	1.00		1.00	1.00		1.00
Lane Grp Cap(c), veh/h	116	91	77	113	91	77	32	2760	1231	79	2854	1273
V/C Ratio(X)	0.10	0.09	0.51	0.28	0.03	0.70	0.79	0.28	0.05	0.79	0.38	0.03
Avail Cap(c_a), veh/h	338	400	339	337	400	339	194	2760	1231	194	2854	1273
HCM Platoon Ratio	1.00	1.00	1.00	1.00	1.00	1.00	1.00	1.00	1.00	2.00	2.00	2.00
Upstream Filter(l)	1.00	1.00	1.00	1.00	1.00	1.00	1.00	1.00	1.00	0.78	0.78	0.78
Uniform Delay (d), s/veh	63.2	62.7	64.0	64.5	62.5	64.6	67.5	4.4	3.6	62.2	0.0	0.0
Incr Delay (d2), s/veh	0.1	0.2	1.9	0.5	0.1	4.2	14.4	0.3	0.1	5.0	0.3	0.0
Initial Q Delay(d3),s/veh	0.0	0.0	0.0	0.0	0.0	0.0	0.0	0.0	0.0	0.0	0.0	0.0
%ile BackOfQ(50%),veh/ln	0.4	0.3	1.4	1.1	0.1	2.0	1.0	2.9	0.4	2.2	0.1	0.0
Unsig. Movement Delay, s/veh												
LnGrp Delay(d),s/veh	63.3	62.9	65.9	65.0	62.6	68.9	82.0	4.7	3.7	67.2	0.3	0.0
LnGrp LOS	E	E	E	E	E	E	F	A	A	E	A	A
Approach Vol, veh/h		58			89			865			1195	
Approach Delay, s/veh		65.0			67.3			6.8			3.8	
Approach LOS		E			E			A			A	
Timer - Assigned Phs	1	2		4	5	6		8				
Phs Duration (G+Y+Rc), s	11.1	113.7		13.2	7.5	117.3		13.2				
Change Period (Y+Rc), s	5.0	6.5		6.5	5.0	6.5		6.5				
Max Green Setting (Gmax), s	15.0	75.5		29.5	15.0	75.5		29.5				
Max Q Clear Time (g_c+I1), s	6.7	10.6		5.3	3.9	2.0		6.6				
Green Ext Time (p_c), s	0.0	4.2		0.1	0.0	6.6		0.1				

Intersection Summary

HCM 6th Ctrl Delay	9.1
HCM 6th LOS	A

HCM 6th Signalized Intersection Summary
 7: Voyager Pkwy & S. Spectrum Loop

2024 Background PM

09/06/2022

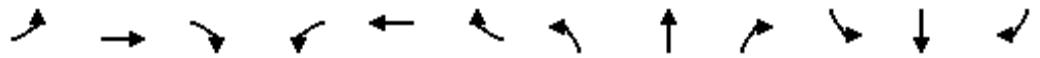

Movement	EBL	EBT	EBR	WBL	WBT	WBR	NBL	NBT	NBR	SBL	SBT	SBR
Lane Configurations												
Traffic Volume (veh/h)	44	4	72	54	4	84	82	778	66	48	783	34
Future Volume (veh/h)	44	4	72	54	4	84	82	778	66	48	783	34
Initial Q (Qb), veh	0	0	0	0	0	0	0	0	0	0	0	0
Ped-Bike Adj(A_pbT)	1.00		1.00	1.00		1.00	1.00		1.00	1.00		1.00
Parking Bus, Adj	1.00	1.00	1.00	1.00	1.00	1.00	1.00	1.00	1.00	1.00	1.00	1.00
Work Zone On Approach		No			No			No			No	
Adj Sat Flow, veh/h/ln	1870	1870	1870	1870	1870	1870	1870	1870	1870	1870	1870	1870
Adj Flow Rate, veh/h	48	4	78	59	4	91	89	846	72	52	851	37
Peak Hour Factor	0.92	0.92	0.92	0.92	0.92	0.92	0.92	0.92	0.92	0.92	0.92	0.92
Percent Heavy Veh, %	2	2	2	2	2	2	2	2	2	2	2	2
Cap, veh/h	144	136	115	145	136	115	110	2699	1204	67	2612	1165
Arrive On Green	0.07	0.07	0.07	0.07	0.07	0.07	0.06	0.76	0.76	0.07	1.00	1.00
Sat Flow, veh/h	1301	1870	1585	1316	1870	1585	1781	3554	1585	1781	3554	1585
Grp Volume(v), veh/h	48	4	78	59	4	91	89	846	72	52	851	37
Grp Sat Flow(s),veh/h/ln	1301	1870	1585	1316	1870	1585	1781	1777	1585	1781	1777	1585
Q Serve(g_s), s	4.9	0.3	6.6	6.0	0.3	7.8	6.8	10.4	1.6	4.0	0.0	0.0
Cycle Q Clear(g_c), s	5.2	0.3	6.6	6.3	0.3	7.8	6.8	10.4	1.6	4.0	0.0	0.0
Prop In Lane	1.00		1.00	1.00		1.00	1.00		1.00	1.00		1.00
Lane Grp Cap(c), veh/h	144	136	115	145	136	115	110	2699	1204	67	2612	1165
V/C Ratio(X)	0.33	0.03	0.68	0.41	0.03	0.79	0.81	0.31	0.06	0.78	0.33	0.03
Avail Cap(c_a), veh/h	328	400	339	331	400	339	194	2699	1204	194	2612	1165
HCM Platoon Ratio	1.00	1.00	1.00	1.00	1.00	1.00	1.00	1.00	1.00	2.00	2.00	2.00
Upstream Filter(l)	1.00	1.00	1.00	1.00	1.00	1.00	1.00	1.00	1.00	0.89	0.89	0.89
Uniform Delay (d), s/veh	61.9	59.5	62.4	62.4	59.5	63.0	63.9	5.2	4.2	63.3	0.0	0.0
Incr Delay (d2), s/veh	0.5	0.0	2.6	0.7	0.0	4.5	5.1	0.3	0.1	6.4	0.3	0.0
Initial Q Delay(d3),s/veh	0.0	0.0	0.0	0.0	0.0	0.0	0.0	0.0	0.0	0.0	0.0	0.0
%ile BackOfQ(50%),veh/ln	1.7	0.1	2.8	2.0	0.1	3.3	3.3	3.6	0.5	1.9	0.1	0.0
Unsig. Movement Delay, s/veh												
LnGrp Delay(d),s/veh	62.4	59.5	65.0	63.1	59.5	67.5	69.0	5.5	4.3	69.7	0.3	0.0
LnGrp LOS	E	E	E	E	E	E	E	A	A	E	A	A
Approach Vol, veh/h		130			154			1007			940	
Approach Delay, s/veh		63.9			65.6			11.1			4.1	
Approach LOS		E			E			B			A	
Timer - Assigned Phs	1	2		4	5	6		8				
Phs Duration (G+Y+Rc), s	10.2	111.3		16.5	13.6	107.9		16.5				
Change Period (Y+Rc), s	5.0	6.5		6.5	5.0	6.5		6.5				
Max Green Setting (Gmax), s	15.0	75.5		29.5	15.0	75.5		29.5				
Max Q Clear Time (g_c+I1), s	6.0	12.4		8.6	8.8	2.0		9.8				
Green Ext Time (p_c), s	0.0	4.7		0.2	0.0	4.7		0.2				

Intersection Summary

HCM 6th Ctrl Delay	15.0
HCM 6th LOS	B

HCM 6th Signalized Intersection Summary
 7: Voyager Pkwy & S. Spectrum Loop

2024 Total AM

09/06/2022

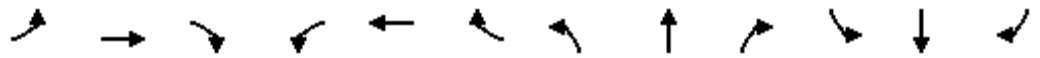

Movement	EBL	EBT	EBR	WBL	WBT	WBR	NBL	NBT	NBR	SBL	SBT	SBR
Lane Configurations	↖	↗	↘	↖	↗	↘	↖	↕	↘	↖	↗	↘
Traffic Volume (veh/h)	10	7	36	29	3	50	23	713	62	57	1010	38
Future Volume (veh/h)	10	7	36	29	3	50	23	713	62	57	1010	38
Initial Q (Qb), veh	0	0	0	0	0	0	0	0	0	0	0	0
Ped-Bike Adj(A_pbT)	1.00		1.00	1.00		1.00	1.00		1.00	1.00		1.00
Parking Bus, Adj	1.00	1.00	1.00	1.00	1.00	1.00	1.00	1.00	1.00	1.00	1.00	1.00
Work Zone On Approach		No			No			No			No	
Adj Sat Flow, veh/h/ln	1870	1870	1870	1870	1870	1870	1870	1870	1870	1870	1870	1870
Adj Flow Rate, veh/h	11	8	39	32	3	54	25	775	67	62	1098	41
Peak Hour Factor	0.92	0.92	0.92	0.92	0.92	0.92	0.92	0.92	0.92	0.92	0.92	0.92
Percent Heavy Veh, %	2	2	2	2	2	2	2	2	2	2	2	2
Cap, veh/h	116	91	77	113	91	77	32	2760	1231	79	2854	1273
Arrive On Green	0.05	0.05	0.05	0.05	0.05	0.05	0.02	0.78	0.78	0.09	1.00	1.00
Sat Flow, veh/h	1346	1870	1585	1359	1870	1585	1781	3554	1585	1781	3554	1585
Grp Volume(v), veh/h	11	8	39	32	3	54	25	775	67	62	1098	41
Grp Sat Flow(s),veh/h/ln	1346	1870	1585	1359	1870	1585	1781	1777	1585	1781	1777	1585
Q Serve(g_s), s	1.1	0.6	3.3	3.2	0.2	4.6	1.9	8.6	1.4	4.7	0.0	0.0
Cycle Q Clear(g_c), s	1.3	0.6	3.3	3.7	0.2	4.6	1.9	8.6	1.4	4.7	0.0	0.0
Prop In Lane	1.00		1.00	1.00		1.00	1.00		1.00	1.00		1.00
Lane Grp Cap(c), veh/h	116	91	77	113	91	77	32	2760	1231	79	2854	1273
V/C Ratio(X)	0.10	0.09	0.51	0.28	0.03	0.70	0.79	0.28	0.05	0.79	0.38	0.03
Avail Cap(c_a), veh/h	338	400	339	337	400	339	194	2760	1231	194	2854	1273
HCM Platoon Ratio	1.00	1.00	1.00	1.00	1.00	1.00	1.00	1.00	1.00	2.00	2.00	2.00
Upstream Filter(I)	1.00	1.00	1.00	1.00	1.00	1.00	1.00	1.00	1.00	0.78	0.78	0.78
Uniform Delay (d), s/veh	63.2	62.7	64.0	64.5	62.5	64.6	67.5	4.4	3.6	62.2	0.0	0.0
Incr Delay (d2), s/veh	0.1	0.2	1.9	0.5	0.1	4.2	14.4	0.3	0.1	5.0	0.3	0.0
Initial Q Delay(d3),s/veh	0.0	0.0	0.0	0.0	0.0	0.0	0.0	0.0	0.0	0.0	0.0	0.0
%ile BackOfQ(50%),veh/ln	0.4	0.3	1.4	1.1	0.1	2.0	1.0	2.9	0.4	2.2	0.1	0.0
Unsig. Movement Delay, s/veh												
LnGrp Delay(d),s/veh	63.3	62.9	65.9	65.0	62.6	68.9	82.0	4.7	3.7	67.2	0.3	0.0
LnGrp LOS	E	E	E	E	E	E	F	A	A	E	A	A
Approach Vol, veh/h		58			89			867			1201	
Approach Delay, s/veh		65.0			67.3			6.8			3.8	
Approach LOS		E			E			A			A	
Timer - Assigned Phs	1	2		4	5	6		8				
Phs Duration (G+Y+Rc), s	11.1	113.7		13.2	7.5	117.3		13.2				
Change Period (Y+Rc), s	5.0	6.5		6.5	5.0	6.5		6.5				
Max Green Setting (Gmax), s	15.0	75.5		29.5	15.0	75.5		29.5				
Max Q Clear Time (g_c+I1), s	6.7	10.6		5.3	3.9	2.0		6.6				
Green Ext Time (p_c), s	0.0	4.2		0.1	0.0	6.7		0.1				

Intersection Summary

























HCM 6th Ctrl Delay	9.1
HCM 6th LOS	A

Timings

2024 Total PM

7: Voyager Pkwy & S. Spectrum Loop

09/06/2022

												
Lane Group	EBL	EBT	EBR	WBL	WBT	WBR	NBL	NBT	NBR	SBL	SBT	SBR
Lane Configurations												
Traffic Volume (vph)	44	4	72	54	4	84	82	783	66	48	787	34
Future Volume (vph)	44	4	72	54	4	84	82	783	66	48	787	34
Turn Type	Perm	NA	Perm	Perm	NA	Perm	Prot	NA	Perm	Prot	NA	Perm
Protected Phases		4			8		5	2		1	6	
Permitted Phases	4		4	8		8			2			6
Detector Phase	4	4	4	8	8	8	5	2	2	1	6	6
Switch Phase												
Minimum Initial (s)	4.0	4.0	4.0	4.0	4.0	4.0	4.0	4.0	4.0	4.0	4.0	4.0
Minimum Split (s)	10.5	10.5	10.5	35.5	35.5	35.5	9.5	37.5	37.5	9.5	49.5	49.5
Total Split (s)	36.0	36.0	36.0	36.0	36.0	36.0	20.0	82.0	82.0	20.0	82.0	82.0
Total Split (%)	26.1%	26.1%	26.1%	26.1%	26.1%	26.1%	14.5%	59.4%	59.4%	14.5%	59.4%	59.4%
Yellow Time (s)	4.5	4.5	4.5	4.5	4.5	4.5	3.0	4.5	4.5	3.0	4.5	4.5
All-Red Time (s)	2.0	2.0	2.0	2.0	2.0	2.0	2.0	2.0	2.0	2.0	2.0	2.0
Lost Time Adjust (s)	0.0	0.0	0.0	0.0	0.0	0.0	0.0	0.0	0.0	0.0	0.0	0.0
Total Lost Time (s)	6.5	6.5	6.5	6.5	6.5	6.5	5.0	6.5	6.5	5.0	6.5	6.5
Lead/Lag							Lead	Lag	Lag	Lead	Lag	Lag
Lead-Lag Optimize?							Yes	Yes	Yes	Yes	Yes	Yes
Recall Mode	None	None	None	None	None	None	None	C-Max	C-Max	None	C-Max	C-Max
Act Effct Green (s)	10.2	10.2	10.2	10.2	10.2	10.2	11.3	103.3	103.3	8.5	98.5	98.5
Actuated g/C Ratio	0.07	0.07	0.07	0.07	0.07	0.07	0.08	0.75	0.75	0.06	0.71	0.71
v/c Ratio	0.47	0.03	0.41	0.57	0.03	0.45	0.62	0.32	0.06	0.48	0.34	0.03
Control Delay	74.4	56.8	18.6	81.8	56.8	18.3	78.7	7.1	1.7	77.8	5.6	0.2
Queue Delay	0.0	0.0	0.0	0.0	0.0	0.0	0.0	0.0	0.0	0.0	0.0	0.0
Total Delay	74.4	56.8	18.6	81.8	56.8	18.3	78.7	7.1	1.7	77.8	5.6	0.2
LOS	E	E	B	F	E	B	E	A	A	E	A	A
Approach Delay		40.4			43.6			13.0			9.4	
Approach LOS		D			D			B			A	

Intersection Summary		
Cycle Length: 138		
Actuated Cycle Length: 138		
Offset: 79 (57%), Referenced to phase 2:NBT and 6:SBT, Start of Green		
Natural Cycle: 95		
Control Type: Actuated-Coordinated		
Maximum v/c Ratio: 0.62		
Intersection Signal Delay: 15.2		Intersection LOS: B
Intersection Capacity Utilization 51.0%		ICU Level of Service A
Analysis Period (min) 15		

Splits and Phases: 7: Voyager Pkwy & S. Spectrum Loop



HCM 6th Signalized Intersection Summary
 7: Voyager Pkwy & S. Spectrum Loop

2024 Total PM
 09/06/2022



Movement	EBL	EBT	EBR	WBL	WBT	WBR	NBL	NBT	NBR	SBL	SBT	SBR
Lane Configurations												
Traffic Volume (veh/h)	44	4	72	54	4	84	82	783	66	48	787	34
Future Volume (veh/h)	44	4	72	54	4	84	82	783	66	48	787	34
Initial Q (Qb), veh	0	0	0	0	0	0	0	0	0	0	0	0
Ped-Bike Adj(A_pbT)	1.00		1.00	1.00		1.00	1.00		1.00	1.00		1.00
Parking Bus, Adj	1.00	1.00	1.00	1.00	1.00	1.00	1.00	1.00	1.00	1.00	1.00	1.00
Work Zone On Approach		No			No			No			No	
Adj Sat Flow, veh/h/ln	1870	1870	1870	1870	1870	1870	1870	1870	1870	1870	1870	1870
Adj Flow Rate, veh/h	48	4	78	59	4	91	89	851	72	52	855	37
Peak Hour Factor	0.92	0.92	0.92	0.92	0.92	0.92	0.92	0.92	0.92	0.92	0.92	0.92
Percent Heavy Veh, %	2	2	2	2	2	2	2	2	2	2	2	2
Cap, veh/h	144	136	115	145	136	115	110	2699	1204	67	2612	1165
Arrive On Green	0.07	0.07	0.07	0.07	0.07	0.07	0.06	0.76	0.76	0.07	1.00	1.00
Sat Flow, veh/h	1301	1870	1585	1316	1870	1585	1781	3554	1585	1781	3554	1585
Grp Volume(v), veh/h	48	4	78	59	4	91	89	851	72	52	855	37
Grp Sat Flow(s),veh/h/ln	1301	1870	1585	1316	1870	1585	1781	1777	1585	1781	1777	1585
Q Serve(g_s), s	4.9	0.3	6.6	6.0	0.3	7.8	6.8	10.4	1.6	4.0	0.0	0.0
Cycle Q Clear(g_c), s	5.2	0.3	6.6	6.3	0.3	7.8	6.8	10.4	1.6	4.0	0.0	0.0
Prop In Lane	1.00		1.00	1.00		1.00	1.00		1.00	1.00		1.00
Lane Grp Cap(c), veh/h	144	136	115	145	136	115	110	2699	1204	67	2612	1165
V/C Ratio(X)	0.33	0.03	0.68	0.41	0.03	0.79	0.81	0.32	0.06	0.78	0.33	0.03
Avail Cap(c_a), veh/h	328	400	339	331	400	339	194	2699	1204	194	2612	1165
HCM Platoon Ratio	1.00	1.00	1.00	1.00	1.00	1.00	1.00	1.00	1.00	2.00	2.00	2.00
Upstream Filter(l)	1.00	1.00	1.00	1.00	1.00	1.00	1.00	1.00	1.00	0.89	0.89	0.89
Uniform Delay (d), s/veh	61.9	59.5	62.4	62.4	59.5	63.0	63.9	5.2	4.2	63.3	0.0	0.0
Incr Delay (d2), s/veh	0.5	0.0	2.6	0.7	0.0	4.5	5.1	0.3	0.1	6.4	0.3	0.0
Initial Q Delay(d3),s/veh	0.0	0.0	0.0	0.0	0.0	0.0	0.0	0.0	0.0	0.0	0.0	0.0
%ile BackOfQ(50%),veh/ln	1.7	0.1	2.8	2.0	0.1	3.3	3.3	3.6	0.5	1.9	0.1	0.0
Unsig. Movement Delay, s/veh												
LnGrp Delay(d),s/veh	62.4	59.5	65.0	63.1	59.5	67.5	69.0	5.6	4.3	69.7	0.3	0.0
LnGrp LOS	E	E	E	E	E	E	E	A	A	E	A	A
Approach Vol, veh/h		130			154			1012			944	
Approach Delay, s/veh		63.9			65.6			11.0			4.1	
Approach LOS		E			E			B			A	
Timer - Assigned Phs	1	2		4	5	6		8				
Phs Duration (G+Y+Rc), s	10.2	111.3		16.5	13.6	107.9		16.5				
Change Period (Y+Rc), s	5.0	6.5		6.5	5.0	6.5		6.5				
Max Green Setting (Gmax), s	15.0	75.5		29.5	15.0	75.5		29.5				
Max Q Clear Time (g_c+I1), s	6.0	12.4		8.6	8.8	2.0		9.8				
Green Ext Time (p_c), s	0.0	4.7		0.2	0.0	4.7		0.2				

Intersection Summary

HCM 6th Ctrl Delay	14.9
HCM 6th LOS	B

Timings
7: Voyager Pkwy & S. Spectrum Loop

Lane Group	EBL	EBT	EBR	WBL	WBT	WBR	NBL	NBT	NBR	SBL	SBT	SBR
Lane Configurations												
Traffic Volume (vph)	15	14	40	52	6	91	33	1297	114	104	1828	67
Future Volume (vph)	15	14	40	52	6	91	33	1297	114	104	1828	67
Turn Type	Perm	NA	Perm	Perm	NA	Perm	Prot	NA	Perm	Prot	NA	Perm
Protected Phases		4			8		5	2		1	6	
Permitted Phases	4		4	8		8			2			6
Detector Phase	4	4	4	8	8	8	5	2	2	1	6	6
Switch Phase												
Minimum Initial (s)	4.0	4.0	4.0	4.0	4.0	4.0	4.0	4.0	4.0	4.0	4.0	4.0
Minimum Split (s)	10.5	10.5	10.5	35.5	35.5	35.5	9.5	37.5	37.5	9.5	49.5	49.5
Total Split (s)	36.0	36.0	36.0	36.0	36.0	36.0	20.0	82.0	82.0	20.0	82.0	82.0
Total Split (%)	26.1%	26.1%	26.1%	26.1%	26.1%	26.1%	14.5%	59.4%	59.4%	14.5%	59.4%	59.4%
Yellow Time (s)	4.5	4.5	4.5	4.5	4.5	4.5	3.0	4.5	4.5	3.0	4.5	4.5
All-Red Time (s)	2.0	2.0	2.0	2.0	2.0	2.0	2.0	2.0	2.0	2.0	2.0	2.0
Lost Time Adjust (s)	0.0	0.0	0.0	0.0	0.0	0.0	0.0	0.0	0.0	0.0	0.0	0.0
Total Lost Time (s)	6.5	6.5	6.5	6.5	6.5	6.5	5.0	6.5	6.5	5.0	6.5	6.5
Lead/Lag							Lead	Lag	Lag	Lead	Lag	Lag
Lead-Lag Optimize?							Yes	Yes	Yes	Yes	Yes	Yes
Recall Mode	None	None	None	None	None	None	None	C-Max	C-Max	None	C-Max	C-Max
Act Effct Green (s)	10.1	10.1	10.1	10.1	10.1	10.1	7.3	96.8	96.8	13.1	104.6	104.6
Actuated g/C Ratio	0.07	0.07	0.07	0.07	0.07	0.07	0.05	0.70	0.70	0.09	0.76	0.76
v/c Ratio	0.16	0.11	0.24	0.56	0.05	0.48	0.39	0.57	0.11	0.67	0.74	0.06
Control Delay	61.3	59.4	8.2	81.7	57.7	18.5	74.3	12.3	3.3	59.7	12.9	2.5
Queue Delay	0.0	0.0	0.0	0.0	0.0	0.0	0.0	0.0	0.0	0.0	1.0	0.0
Total Delay	61.3	59.4	8.2	81.7	57.7	18.5	74.3	12.3	3.3	59.7	13.9	2.5
LOS	E	E	A	F	E	B	E	B	A	E	B	A
Approach Delay		30.0			42.3			13.0			15.9	
Approach LOS		C			D			B			B	

Intersection Summary

Cycle Length: 138
 Actuated Cycle Length: 138
 Offset: 79 (57%), Referenced to phase 2:NBT and 6:SBT, Start of Green
 Natural Cycle: 115
 Control Type: Actuated-Coordinated
 Maximum v/c Ratio: 0.74
 Intersection Signal Delay: 16.1
 Intersection LOS: B
 Intersection Capacity Utilization 78.4%
 ICU Level of Service D
 Analysis Period (min) 15

Splits and Phases: 7: Voyager Pkwy & S. Spectrum Loop

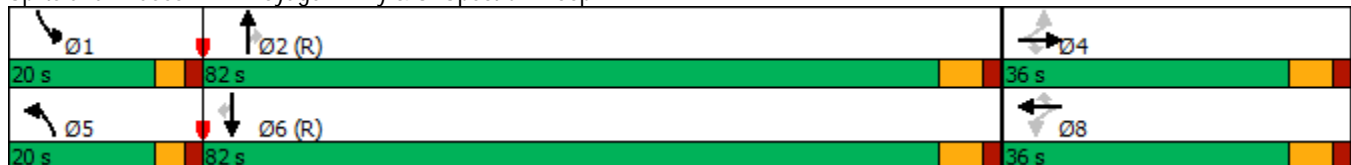

HCM 6th Signalized Intersection Summary
 7: Voyager Pkwy & S. Spectrum Loop

2045 Background AM

09/06/2022

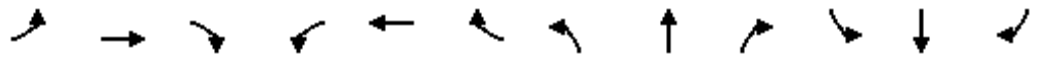

Movement	EBL	EBT	EBR	WBL	WBT	WBR	NBL	NBT	NBR	SBL	SBT	SBR
Lane Configurations												
Traffic Volume (veh/h)	15	14	40	52	6	91	33	1297	114	104	1828	67
Future Volume (veh/h)	15	14	40	52	6	91	33	1297	114	104	1828	67
Initial Q (Qb), veh	0	0	0	0	0	0	0	0	0	0	0	0
Ped-Bike Adj(A_pbT)	1.00		1.00	1.00		1.00	1.00		1.00	1.00		1.00
Parking Bus, Adj	1.00	1.00	1.00	1.00	1.00	1.00	1.00	1.00	1.00	1.00	1.00	1.00
Work Zone On Approach		No			No			No			No	
Adj Sat Flow, veh/h/ln	1870	1870	1870	1870	1870	1870	1870	1870	1870	1870	1870	1870
Adj Flow Rate, veh/h	16	15	43	57	7	99	36	1410	124	113	1987	73
Peak Hour Factor	0.92	0.92	0.92	0.92	0.92	0.92	0.92	0.92	0.92	0.92	0.92	0.92
Percent Heavy Veh, %	2	2	2	2	2	2	2	2	2	2	2	2
Cap, veh/h	148	145	123	147	145	123	46	2546	1136	135	2722	1214
Arrive On Green	0.08	0.08	0.08	0.08	0.08	0.08	0.03	0.72	0.72	0.15	1.00	1.00
Sat Flow, veh/h	1288	1870	1585	1345	1870	1585	1781	3554	1585	1781	3554	1585
Grp Volume(v), veh/h	16	15	43	57	7	99	36	1410	124	113	1987	73
Grp Sat Flow(s),veh/h/ln	1288	1870	1585	1345	1870	1585	1781	1777	1585	1781	1777	1585
Q Serve(g_s), s	1.6	1.0	3.5	5.7	0.5	8.5	2.8	25.7	3.3	8.5	0.0	0.0
Cycle Q Clear(g_c), s	2.1	1.0	3.5	6.7	0.5	8.5	2.8	25.7	3.3	8.5	0.0	0.0
Prop In Lane	1.00		1.00	1.00		1.00	1.00		1.00	1.00		1.00
Lane Grp Cap(c), veh/h	148	145	123	147	145	123	46	2546	1136	135	2722	1214
V/C Ratio(X)	0.11	0.10	0.35	0.39	0.05	0.80	0.78	0.55	0.11	0.84	0.73	0.06
Avail Cap(c_a), veh/h	323	400	339	330	400	339	194	2546	1136	194	2722	1214
HCM Platoon Ratio	1.00	1.00	1.00	1.00	1.00	1.00	1.00	1.00	1.00	2.00	2.00	2.00
Upstream Filter(l)	1.00	1.00	1.00	1.00	1.00	1.00	1.00	1.00	1.00	0.09	0.09	0.09
Uniform Delay (d), s/veh	59.9	59.2	60.3	62.3	58.9	62.6	66.8	9.2	6.0	57.8	0.0	0.0
Incr Delay (d2), s/veh	0.1	0.1	0.6	0.6	0.1	4.6	10.0	0.9	0.2	1.4	0.2	0.0
Initial Q Delay(d3),s/veh	0.0	0.0	0.0	0.0	0.0	0.0	0.0	0.0	0.0	0.0	0.0	0.0
%ile BackOfQ(50%),veh/ln	0.5	0.5	1.5	2.0	0.2	3.6	1.4	9.7	1.1	3.6	0.1	0.0
Unsig. Movement Delay, s/veh												
LnGrp Delay(d),s/veh	60.0	59.3	61.0	62.9	59.0	67.2	76.8	10.1	6.2	59.2	0.2	0.0
LnGrp LOS	E	E	E	E	E	E	E	B	A	E	A	A
Approach Vol, veh/h		74			163			1570			2173	
Approach Delay, s/veh		60.4			65.3			11.3			3.2	
Approach LOS		E			E			B			A	
Timer - Assigned Phs	1	2		4	5	6		8				
Phs Duration (G+Y+Rc), s	15.4	105.4		17.2	8.6	112.2		17.2				
Change Period (Y+Rc), s	5.0	6.5		6.5	5.0	6.5		6.5				
Max Green Setting (Gmax), s	15.0	75.5		29.5	15.0	75.5		29.5				
Max Q Clear Time (g_c+l1), s	10.5	27.7		5.5	4.8	2.0		10.5				
Green Ext Time (p_c), s	0.0	10.1		0.1	0.0	20.8		0.2				

Intersection Summary

HCM 6th Ctrl Delay	10.0
HCM 6th LOS	B

Timings
7: Voyager Pkwy & S. Spectrum Loop

Lane Group	EBL	EBT	EBR	WBL	WBT	WBR	NBL	NBT	NBR	SBL	SBT	SBR
Lane Configurations												
Traffic Volume (vph)	74	8	114	98	8	152	122	1420	120	87	1425	57
Future Volume (vph)	74	8	114	98	8	152	122	1420	120	87	1425	57
Turn Type	Perm	NA	Perm	Perm	NA	Perm	Prot	NA	Perm	Prot	NA	Perm
Protected Phases		4			8		5	2		1	6	
Permitted Phases	4		4	8		8			2			6
Detector Phase	4	4	4	8	8	8	5	2	2	1	6	6
Switch Phase												
Minimum Initial (s)	4.0	4.0	4.0	4.0	4.0	4.0	4.0	4.0	4.0	4.0	4.0	4.0
Minimum Split (s)	10.5	10.5	10.5	35.5	35.5	35.5	9.5	37.5	37.5	9.5	49.5	49.5
Total Split (s)	36.0	36.0	36.0	36.0	36.0	36.0	20.0	82.0	82.0	20.0	82.0	82.0
Total Split (%)	26.1%	26.1%	26.1%	26.1%	26.1%	26.1%	14.5%	59.4%	59.4%	14.5%	59.4%	59.4%
Yellow Time (s)	4.5	4.5	4.5	4.5	4.5	4.5	3.0	4.5	4.5	3.0	4.5	4.5
All-Red Time (s)	2.0	2.0	2.0	2.0	2.0	2.0	2.0	2.0	2.0	2.0	2.0	2.0
Lost Time Adjust (s)	0.0	0.0	0.0	0.0	0.0	0.0	0.0	0.0	0.0	0.0	0.0	0.0
Total Lost Time (s)	6.5	6.5	6.5	6.5	6.5	6.5	5.0	6.5	6.5	5.0	6.5	6.5
Lead/Lag							Lead	Lag	Lag	Lead	Lag	Lag
Lead-Lag Optimize?							Yes	Yes	Yes	Yes	Yes	Yes
Recall Mode	None	None	None	None	None	None	None	C-Max	C-Max	None	C-Max	C-Max
Act Effct Green (s)	14.9	14.9	14.9	14.9	14.9	14.9	14.9	93.3	93.3	11.8	90.1	90.1
Actuated g/C Ratio	0.11	0.11	0.11	0.11	0.11	0.11	0.11	0.68	0.68	0.09	0.65	0.65
v/c Ratio	0.53	0.04	0.44	0.71	0.04	0.52	0.70	0.65	0.12	0.63	0.67	0.06
Control Delay	69.5	52.1	13.6	82.7	52.1	13.5	77.6	15.8	4.4	73.3	17.1	3.9
Queue Delay	0.0	0.0	0.0	0.0	0.0	0.0	0.0	0.0	0.0	0.0	0.2	0.0
Total Delay	69.5	52.1	13.6	82.7	52.1	13.5	77.6	15.8	4.4	73.3	17.3	3.9
LOS	E	D	B	F	D	B	E	B	A	E	B	A
Approach Delay		36.2			41.1			19.5			19.9	
Approach LOS		D			D			B			B	

Intersection Summary

Cycle Length: 138
 Actuated Cycle Length: 138
 Offset: 79 (57%), Referenced to phase 2:NBT and 6:SBT, Start of Green
 Natural Cycle: 95
 Control Type: Actuated-Coordinated
 Maximum v/c Ratio: 0.71
 Intersection Signal Delay: 22.1
 Intersection LOS: C
 Intersection Capacity Utilization 73.2%
 ICU Level of Service D
 Analysis Period (min) 15

Splits and Phases: 7: Voyager Pkwy & S. Spectrum Loop



HCM 6th Signalized Intersection Summary
 7: Voyager Pkwy & S. Spectrum Loop

2045 Background PM

09/06/2022

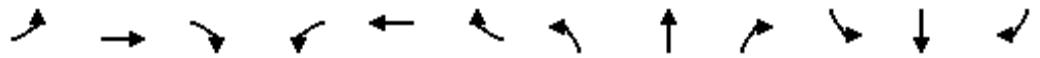

Movement	EBL	EBT	EBR	WBL	WBT	WBR	NBL	NBT	NBR	SBL	SBT	SBR
Lane Configurations												
Traffic Volume (veh/h)	74	8	114	98	8	152	122	1420	120	87	1425	57
Future Volume (veh/h)	74	8	114	98	8	152	122	1420	120	87	1425	57
Initial Q (Qb), veh	0	0	0	0	0	0	0	0	0	0	0	0
Ped-Bike Adj(A_pbT)	1.00		1.00	1.00		1.00	1.00		1.00	1.00		1.00
Parking Bus, Adj	1.00	1.00	1.00	1.00	1.00	1.00	1.00	1.00	1.00	1.00	1.00	1.00
Work Zone On Approach		No			No			No			No	
Adj Sat Flow, veh/h/ln	1870	1870	1870	1870	1870	1870	1870	1870	1870	1870	1870	1870
Adj Flow Rate, veh/h	80	9	124	107	9	165	133	1543	130	95	1549	62
Peak Hour Factor	0.92	0.92	0.92	0.92	0.92	0.92	0.92	0.92	0.92	0.92	0.92	0.92
Percent Heavy Veh, %	2	2	2	2	2	2	2	2	2	2	2	2
Cap, veh/h	192	224	190	197	224	190	157	2433	1085	116	2352	1049
Arrive On Green	0.12	0.12	0.12	0.12	0.12	0.12	0.09	0.68	0.68	0.13	1.00	1.00
Sat Flow, veh/h	1211	1870	1585	1257	1870	1585	1781	3554	1585	1781	3554	1585
Grp Volume(v), veh/h	80	9	124	107	9	165	133	1543	130	95	1549	62
Grp Sat Flow(s),veh/h/ln	1211	1870	1585	1257	1870	1585	1781	1777	1585	1781	1777	1585
Q Serve(g_s), s	8.6	0.6	10.3	11.4	0.6	14.1	10.2	33.4	3.9	7.2	0.0	0.0
Cycle Q Clear(g_c), s	9.2	0.6	10.3	11.9	0.6	14.1	10.2	33.4	3.9	7.2	0.0	0.0
Prop In Lane	1.00		1.00	1.00		1.00	1.00		1.00	1.00		1.00
Lane Grp Cap(c), veh/h	192	224	190	197	224	190	157	2433	1085	116	2352	1049
V/C Ratio(X)	0.42	0.04	0.65	0.54	0.04	0.87	0.85	0.63	0.12	0.82	0.66	0.06
Avail Cap(c_a), veh/h	306	400	339	315	400	339	194	2433	1085	194	2352	1049
HCM Platoon Ratio	1.00	1.00	1.00	1.00	1.00	1.00	1.00	1.00	1.00	2.00	2.00	2.00
Upstream Filter(l)	1.00	1.00	1.00	1.00	1.00	1.00	1.00	1.00	1.00	0.50	0.50	0.50
Uniform Delay (d), s/veh	57.8	53.7	58.0	59.0	53.7	59.7	62.0	12.1	7.5	59.2	0.0	0.0
Incr Delay (d2), s/veh	0.5	0.0	1.4	0.9	0.0	4.7	21.0	1.3	0.2	2.8	0.7	0.1
Initial Q Delay(d3),s/veh	0.0	0.0	0.0	0.0	0.0	0.0	0.0	0.0	0.0	0.0	0.0	0.0
%ile BackOfQ(50%),veh/ln	2.7	0.3	4.2	3.7	0.3	5.9	5.5	13.0	1.4	3.2	0.2	0.0
Unsig. Movement Delay, s/veh												
LnGrp Delay(d),s/veh	58.3	53.7	59.4	59.9	53.7	64.3	83.1	13.4	7.7	62.0	0.7	0.1
LnGrp LOS	E	D	E	E	D	E	F	B	A	E	A	A
Approach Vol, veh/h		213			281			1806			1706	
Approach Delay, s/veh		58.8			62.3			18.1			4.1	
Approach LOS		E			E			B			A	
Timer - Assigned Phs	1	2		4	5	6		8				
Phs Duration (G+Y+Rc), s	14.0	101.0		23.0	17.1	97.8		23.0				
Change Period (Y+Rc), s	5.0	6.5		6.5	5.0	6.5		6.5				
Max Green Setting (Gmax), s	15.0	75.5		29.5	15.0	75.5		29.5				
Max Q Clear Time (g_c+I1), s	9.2	35.4		12.3	12.2	2.0		16.1				
Green Ext Time (p_c), s	0.0	11.5		0.3	0.0	12.1		0.4				

Intersection Summary

HCM 6th Ctrl Delay	17.4
HCM 6th LOS	B

Timings
7: Voyager Pkwy & S. Spectrum Loop

2045 Total AM

09/06/2022

Lane Group	EBL	EBT	EBR	WBL	WBT	WBR	NBL	NBT	NBR	SBL	SBT	SBR
Lane Configurations												
Traffic Volume (vph)	15	14	40	52	6	91	33	1299	114	104	1833	67
Future Volume (vph)	15	14	40	52	6	91	33	1299	114	104	1833	67
Turn Type	Perm	NA	Perm	Perm	NA	Perm	Prot	NA	Perm	Prot	NA	Perm
Protected Phases		4			8		5	2		1	6	
Permitted Phases	4		4	8		8			2			6
Detector Phase	4	4	4	8	8	8	5	2	2	1	6	6
Switch Phase												
Minimum Initial (s)	4.0	4.0	4.0	4.0	4.0	4.0	4.0	4.0	4.0	4.0	4.0	4.0
Minimum Split (s)	10.5	10.5	10.5	35.5	35.5	35.5	9.5	37.5	37.5	9.5	49.5	49.5
Total Split (s)	36.0	36.0	36.0	36.0	36.0	36.0	20.0	82.0	82.0	20.0	82.0	82.0
Total Split (%)	26.1%	26.1%	26.1%	26.1%	26.1%	26.1%	14.5%	59.4%	59.4%	14.5%	59.4%	59.4%
Yellow Time (s)	4.5	4.5	4.5	4.5	4.5	4.5	3.0	4.5	4.5	3.0	4.5	4.5
All-Red Time (s)	2.0	2.0	2.0	2.0	2.0	2.0	2.0	2.0	2.0	2.0	2.0	2.0
Lost Time Adjust (s)	0.0	0.0	0.0	0.0	0.0	0.0	0.0	0.0	0.0	0.0	0.0	0.0
Total Lost Time (s)	6.5	6.5	6.5	6.5	6.5	6.5	5.0	6.5	6.5	5.0	6.5	6.5
Lead/Lag							Lead	Lag	Lag	Lead	Lag	Lag
Lead-Lag Optimize?							Yes	Yes	Yes	Yes	Yes	Yes
Recall Mode	None	None	None	None	None	None	None	C-Max	C-Max	None	C-Max	C-Max
Act Effct Green (s)	10.1	10.1	10.1	10.1	10.1	10.1	7.3	96.8	96.8	13.1	104.6	104.6
Actuated g/C Ratio	0.07	0.07	0.07	0.07	0.07	0.07	0.05	0.70	0.70	0.09	0.76	0.76
v/c Ratio	0.16	0.11	0.24	0.56	0.05	0.48	0.39	0.57	0.11	0.67	0.74	0.06
Control Delay	61.3	59.4	8.2	81.7	57.7	18.5	74.3	12.3	3.3	76.2	16.2	3.2
Queue Delay	0.0	0.0	0.0	0.0	0.0	0.0	0.0	0.0	0.0	0.0	0.1	0.0
Total Delay	61.3	59.4	8.2	81.7	57.7	18.5	74.3	12.3	3.3	76.2	16.2	3.2
LOS	E	E	A	F	E	B	E	B	A	E	B	A
Approach Delay		30.0			42.3			13.0			18.9	
Approach LOS		C			D			B			B	

Intersection Summary

Cycle Length: 138
 Actuated Cycle Length: 138
 Offset: 79 (57%), Referenced to phase 2:NBT and 6:SBT, Start of Green
 Natural Cycle: 115
 Control Type: Actuated-Coordinated
 Maximum v/c Ratio: 0.74
 Intersection Signal Delay: 17.8
 Intersection Capacity Utilization 78.5%
 Analysis Period (min) 15

Intersection LOS: B
 ICU Level of Service D

Splits and Phases: 7: Voyager Pkwy & S. Spectrum Loop

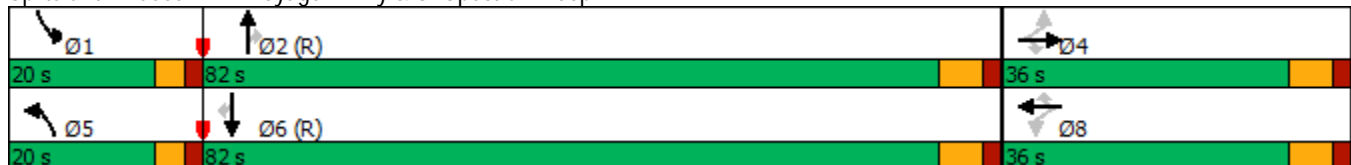

HCM 6th Signalized Intersection Summary
7: Voyager Pkwy & S. Spectrum Loop

2045 Total AM
09/06/2022



Movement	EBL	EBT	EBR	WBL	WBT	WBR	NBL	NBT	NBR	SBL	SBT	SBR
Lane Configurations												
Traffic Volume (veh/h)	15	14	40	52	6	91	33	1299	114	104	1833	67
Future Volume (veh/h)	15	14	40	52	6	91	33	1299	114	104	1833	67
Initial Q (Qb), veh	0	0	0	0	0	0	0	0	0	0	0	0
Ped-Bike Adj(A_pbT)	1.00		1.00	1.00		1.00	1.00		1.00	1.00		1.00
Parking Bus, Adj	1.00	1.00	1.00	1.00	1.00	1.00	1.00	1.00	1.00	1.00	1.00	1.00
Work Zone On Approach		No			No			No			No	
Adj Sat Flow, veh/h/ln	1870	1870	1870	1870	1870	1870	1870	1870	1870	1870	1870	1870
Adj Flow Rate, veh/h	16	15	43	57	7	99	36	1412	124	113	1992	73
Peak Hour Factor	0.92	0.92	0.92	0.92	0.92	0.92	0.92	0.92	0.92	0.92	0.92	0.92
Percent Heavy Veh, %	2	2	2	2	2	2	2	2	2	2	2	2
Cap, veh/h	148	145	123	147	145	123	46	2546	1136	135	2722	1214
Arrive On Green	0.08	0.08	0.08	0.08	0.08	0.08	0.03	0.72	0.72	0.15	1.00	1.00
Sat Flow, veh/h	1288	1870	1585	1345	1870	1585	1781	3554	1585	1781	3554	1585
Grp Volume(v), veh/h	16	15	43	57	7	99	36	1412	124	113	1992	73
Grp Sat Flow(s),veh/h/ln	1288	1870	1585	1345	1870	1585	1781	1777	1585	1781	1777	1585
Q Serve(g_s), s	1.6	1.0	3.5	5.7	0.5	8.5	2.8	25.8	3.3	8.5	0.0	0.0
Cycle Q Clear(g_c), s	2.1	1.0	3.5	6.7	0.5	8.5	2.8	25.8	3.3	8.5	0.0	0.0
Prop In Lane	1.00		1.00	1.00		1.00	1.00		1.00	1.00		1.00
Lane Grp Cap(c), veh/h	148	145	123	147	145	123	46	2546	1136	135	2722	1214
V/C Ratio(X)	0.11	0.10	0.35	0.39	0.05	0.80	0.78	0.55	0.11	0.84	0.73	0.06
Avail Cap(c_a), veh/h	323	400	339	330	400	339	194	2546	1136	194	2722	1214
HCM Platoon Ratio	1.00	1.00	1.00	1.00	1.00	1.00	1.00	1.00	1.00	2.00	2.00	2.00
Upstream Filter(l)	1.00	1.00	1.00	1.00	1.00	1.00	1.00	1.00	1.00	0.83	0.83	0.83
Uniform Delay (d), s/veh	59.9	59.2	60.3	62.3	58.9	62.6	66.8	9.2	6.0	57.8	0.0	0.0
Incr Delay (d2), s/veh	0.1	0.1	0.6	0.6	0.1	4.6	10.0	0.9	0.2	11.7	1.5	0.1
Initial Q Delay(d3),s/veh	0.0	0.0	0.0	0.0	0.0	0.0	0.0	0.0	0.0	0.0	0.0	0.0
%ile BackOfQ(50%),veh/ln	0.5	0.5	1.5	2.0	0.2	3.6	1.4	9.7	1.1	4.0	0.6	0.0
Unsig. Movement Delay, s/veh												
LnGrp Delay(d),s/veh	60.0	59.3	61.0	62.9	59.0	67.2	76.8	10.1	6.2	69.5	1.5	0.1
LnGrp LOS	E	E	E	E	E	E	E	B	A	E	A	A
Approach Vol, veh/h		74			163			1572			2178	
Approach Delay, s/veh		60.4			65.3			11.3			5.0	
Approach LOS		E			E			B			A	
Timer - Assigned Phs	1	2		4	5	6		8				
Phs Duration (G+Y+Rc), s	15.4	105.4		17.2	8.6	112.2		17.2				
Change Period (Y+Rc), s	5.0	6.5		6.5	5.0	6.5		6.5				
Max Green Setting (Gmax), s	15.0	75.5		29.5	15.0	75.5		29.5				
Max Q Clear Time (g_c+l1), s	10.5	27.8		5.5	4.8	2.0		10.5				
Green Ext Time (p_c), s	0.0	10.1		0.1	0.0	21.0		0.2				

Intersection Summary

HCM 6th Ctrl Delay	11.0
HCM 6th LOS	B

Timings
7: Voyager Pkwy & S. Spectrum Loop

2045 Total PM
09/06/2022

Lane Group	EBL	EBT	EBR	WBL	WBT	WBR	NBL	NBT	NBR	SBL	SBT	SBR
Lane Configurations												
Traffic Volume (vph)	74	8	114	98	8	152	122	1425	120	87	1429	57
Future Volume (vph)	74	8	114	98	8	152	122	1425	120	87	1429	57
Turn Type	Perm	NA	Perm	Perm	NA	Perm	Prot	NA	Perm	Prot	NA	Perm
Protected Phases		4			8		5	2		1	6	
Permitted Phases	4		4	8		8			2			6
Detector Phase	4	4	4	8	8	8	5	2	2	1	6	6
Switch Phase												
Minimum Initial (s)	4.0	4.0	4.0	4.0	4.0	4.0	4.0	4.0	4.0	4.0	4.0	4.0
Minimum Split (s)	10.5	10.5	10.5	35.5	35.5	35.5	9.5	37.5	37.5	9.5	49.5	49.5
Total Split (s)	36.0	36.0	36.0	36.0	36.0	36.0	20.0	82.0	82.0	20.0	82.0	82.0
Total Split (%)	26.1%	26.1%	26.1%	26.1%	26.1%	26.1%	14.5%	59.4%	59.4%	14.5%	59.4%	59.4%
Yellow Time (s)	4.5	4.5	4.5	4.5	4.5	4.5	3.0	4.5	4.5	3.0	4.5	4.5
All-Red Time (s)	2.0	2.0	2.0	2.0	2.0	2.0	2.0	2.0	2.0	2.0	2.0	2.0
Lost Time Adjust (s)	0.0	0.0	0.0	0.0	0.0	0.0	0.0	0.0	0.0	0.0	0.0	0.0
Total Lost Time (s)	6.5	6.5	6.5	6.5	6.5	6.5	5.0	6.5	6.5	5.0	6.5	6.5
Lead/Lag							Lead	Lag	Lag	Lead	Lag	Lag
Lead-Lag Optimize?							Yes	Yes	Yes	Yes	Yes	Yes
Recall Mode	None	None	None	None	None	None	None	C-Max	C-Max	None	C-Max	C-Max
Act Effct Green (s)	14.9	14.9	14.9	14.9	14.9	14.9	14.9	93.3	93.3	11.8	90.1	90.1
Actuated g/C Ratio	0.11	0.11	0.11	0.11	0.11	0.11	0.11	0.68	0.68	0.09	0.65	0.65
v/c Ratio	0.53	0.04	0.44	0.71	0.04	0.52	0.70	0.65	0.12	0.63	0.67	0.06
Control Delay	69.5	52.1	13.6	82.7	52.1	13.5	77.6	15.8	4.4	76.4	23.4	5.1
Queue Delay	0.0	0.0	0.0	0.0	0.0	0.0	0.0	0.0	0.0	0.0	0.0	0.0
Total Delay	69.5	52.1	13.6	82.7	52.1	13.5	77.6	15.8	4.4	76.4	23.4	5.1
LOS	E	D	B	F	D	B	E	B	A	E	C	A
Approach Delay		36.2			41.1			19.5			25.7	
Approach LOS		D			D			B			C	

Intersection Summary

Cycle Length: 138
 Actuated Cycle Length: 138
 Offset: 79 (57%), Referenced to phase 2:NBT and 6:SBT, Start of Green
 Natural Cycle: 95
 Control Type: Actuated-Coordinated
 Maximum v/c Ratio: 0.71
 Intersection Signal Delay: 24.5
 Intersection Capacity Utilization 73.4%
 Analysis Period (min) 15
 Intersection LOS: C
 ICU Level of Service D

Splits and Phases: 7: Voyager Pkwy & S. Spectrum Loop



HCM 6th Signalized Intersection Summary
7: Voyager Pkwy & S. Spectrum Loop

2045 Total PM
09/06/2022



Movement	EBL	EBT	EBR	WBL	WBT	WBR	NBL	NBT	NBR	SBL	SBT	SBR
Lane Configurations	↖	↑	↗	↖	↑	↗	↖	↑↑	↗	↖	↑↑	↗
Traffic Volume (veh/h)	74	8	114	98	8	152	122	1425	120	87	1429	57
Future Volume (veh/h)	74	8	114	98	8	152	122	1425	120	87	1429	57
Initial Q (Qb), veh	0	0	0	0	0	0	0	0	0	0	0	0
Ped-Bike Adj(A_pbT)	1.00		1.00	1.00		1.00	1.00		1.00	1.00		1.00
Parking Bus, Adj	1.00	1.00	1.00	1.00	1.00	1.00	1.00	1.00	1.00	1.00	1.00	1.00
Work Zone On Approach		No			No			No			No	
Adj Sat Flow, veh/h/ln	1870	1870	1870	1870	1870	1870	1870	1870	1870	1870	1870	1870
Adj Flow Rate, veh/h	80	9	124	107	9	165	133	1549	130	95	1553	62
Peak Hour Factor	0.92	0.92	0.92	0.92	0.92	0.92	0.92	0.92	0.92	0.92	0.92	0.92
Percent Heavy Veh, %	2	2	2	2	2	2	2	2	2	2	2	2
Cap, veh/h	192	224	190	197	224	190	157	2433	1085	116	2352	1049
Arrive On Green	0.12	0.12	0.12	0.12	0.12	0.12	0.09	0.68	0.68	0.13	1.00	1.00
Sat Flow, veh/h	1211	1870	1585	1257	1870	1585	1781	3554	1585	1781	3554	1585
Grp Volume(v), veh/h	80	9	124	107	9	165	133	1549	130	95	1553	62
Grp Sat Flow(s),veh/h/ln	1211	1870	1585	1257	1870	1585	1781	1777	1585	1781	1777	1585
Q Serve(g_s), s	8.6	0.6	10.3	11.4	0.6	14.1	10.2	33.6	3.9	7.2	0.0	0.0
Cycle Q Clear(g_c), s	9.2	0.6	10.3	11.9	0.6	14.1	10.2	33.6	3.9	7.2	0.0	0.0
Prop In Lane	1.00		1.00	1.00		1.00	1.00		1.00	1.00		1.00
Lane Grp Cap(c), veh/h	192	224	190	197	224	190	157	2433	1085	116	2352	1049
V/C Ratio(X)	0.42	0.04	0.65	0.54	0.04	0.87	0.85	0.64	0.12	0.82	0.66	0.06
Avail Cap(c_a), veh/h	306	400	339	315	400	339	194	2433	1085	194	2352	1049
HCM Platoon Ratio	1.00	1.00	1.00	1.00	1.00	1.00	1.00	1.00	1.00	2.00	2.00	2.00
Upstream Filter(l)	1.00	1.00	1.00	1.00	1.00	1.00	1.00	1.00	1.00	0.89	0.89	0.89
Uniform Delay (d), s/veh	57.8	53.7	58.0	59.0	53.7	59.7	62.0	12.2	7.5	59.2	0.0	0.0
Incr Delay (d2), s/veh	0.5	0.0	1.4	0.9	0.0	4.7	21.0	1.3	0.2	4.8	1.3	0.1
Initial Q Delay(d3),s/veh	0.0	0.0	0.0	0.0	0.0	0.0	0.0	0.0	0.0	0.0	0.0	0.0
%ile BackOfQ(50%),veh/ln	2.7	0.3	4.2	3.7	0.3	5.9	5.5	13.1	1.4	3.2	0.4	0.0
Unsig. Movement Delay, s/veh												
LnGrp Delay(d),s/veh	58.3	53.7	59.4	59.9	53.7	64.3	83.1	13.4	7.7	64.0	1.3	0.1
LnGrp LOS	E	D	E	E	D	E	F	B	A	E	A	A
Approach Vol, veh/h		213			281			1812			1710	
Approach Delay, s/veh		58.8			62.3			18.1			4.8	
Approach LOS		E			E			B			A	
Timer - Assigned Phs	1	2		4	5	6		8				
Phs Duration (G+Y+Rc), s	14.0	101.0		23.0	17.1	97.8		23.0				
Change Period (Y+Rc), s	5.0	6.5		6.5	5.0	6.5		6.5				
Max Green Setting (Gmax), s	15.0	75.5		29.5	15.0	75.5		29.5				
Max Q Clear Time (g_c+I1), s	9.2	35.6		12.3	12.2	2.0		16.1				
Green Ext Time (p_c), s	0.0	11.5		0.3	0.0	12.2		0.4				

Intersection Summary

HCM 6th Ctrl Delay	17.7
HCM 6th LOS	B

Intersection												
Int Delay, s/veh	4											
Movement	EBL	EBT	EBR	WBL	WBT	WBR	NBL	NBT	NBR	SBL	SBT	SBR
Lane Configurations	↖	↗		↖	↗			↕			↕	
Traffic Vol, veh/h	13	67	15	3	110	11	51	0	10	18	0	48
Future Vol, veh/h	13	67	15	3	110	11	51	0	10	18	0	48
Conflicting Peds, #/hr	0	0	0	0	0	0	0	0	0	0	0	0
Sign Control	Free	Free	Free	Free	Free	Free	Stop	Stop	Stop	Stop	Stop	Stop
RT Channelized	-	-	None	-	-	None	-	-	None	-	-	None
Storage Length	75	-	-	50	-	-	-	-	-	-	-	-
Veh in Median Storage, #	-	0	-	-	0	-	-	1	-	-	1	-
Grade, %	-	0	-	-	0	-	-	0	-	-	0	-
Peak Hour Factor	92	92	92	92	92	92	92	92	92	92	92	92
Heavy Vehicles, %	2	2	2	2	2	2	2	2	2	2	2	2
Mvmt Flow	14	73	16	3	120	12	55	0	11	20	0	52

Major/Minor	Major1			Major2			Minor1			Minor2		
Conflicting Flow All	132	0	0	89	0	0	267	247	81	247	249	126
Stage 1	-	-	-	-	-	-	109	109	-	132	132	-
Stage 2	-	-	-	-	-	-	158	138	-	115	117	-
Critical Hdwy	4.12	-	-	4.12	-	-	7.12	6.52	6.22	7.12	6.52	6.22
Critical Hdwy Stg 1	-	-	-	-	-	-	6.12	5.52	-	6.12	5.52	-
Critical Hdwy Stg 2	-	-	-	-	-	-	6.12	5.52	-	6.12	5.52	-
Follow-up Hdwy	2.218	-	-	2.218	-	-	3.518	4.018	3.318	3.518	4.018	3.318
Pot Cap-1 Maneuver	1453	-	-	1522	-	-	717	676	1021	740	674	924
Stage 1	-	-	-	-	-	-	929	821	-	871	787	-
Stage 2	-	-	-	-	-	-	844	782	-	923	814	-
Platoon blocked, %		-	-	1	-	-	1	1	1	1	1	
Mov Cap-1 Maneuver	1453	-	-	1522	-	-	670	668	1021	726	666	924
Mov Cap-2 Maneuver	-	-	-	-	-	-	682	663	-	733	666	-
Stage 1	-	-	-	-	-	-	920	813	-	862	785	-
Stage 2	-	-	-	-	-	-	795	780	-	904	806	-

Approach	EB			WB			NB			SB		
HCM Control Delay, s	1			0.2			10.5			9.5		
HCM LOS							B			A		

Minor Lane/Major Mvmt	NBLn1	EBL	EBT	EBR	WBL	WBT	WBR	SBLn1
Capacity (veh/h)	721	1453	-	-	1522	-	-	863
HCM Lane V/C Ratio	0.092	0.01	-	-	0.002	-	-	0.083
HCM Control Delay (s)	10.5	7.5	-	-	7.4	-	-	9.5
HCM Lane LOS	B	A	-	-	A	-	-	A
HCM 95th %tile Q(veh)	0.3	0	-	-	0	-	-	0.3

Intersection												
Int Delay, s/veh	5.2											
Movement	EBL	EBT	EBR	WBL	WBT	WBR	NBL	NBT	NBR	SBL	SBT	SBR
Lane Configurations	↖	↗		↖	↗			↕			↕	
Traffic Vol, veh/h	150	146	51	10	125	28	37	0	7	11	0	151
Future Vol, veh/h	150	146	51	10	125	28	37	0	7	11	0	151
Conflicting Peds, #/hr	0	0	0	0	0	0	0	0	0	0	0	0
Sign Control	Free	Free	Free	Free	Free	Free	Stop	Stop	Stop	Stop	Stop	Stop
RT Channelized	-	-	None	-	-	None	-	-	None	-	-	None
Storage Length	75	-	-	50	-	-	-	-	-	-	-	-
Veh in Median Storage, #	-	0	-	-	0	-	-	1	-	-	1	-
Grade, %	-	0	-	-	0	-	-	0	-	-	0	-
Peak Hour Factor	92	92	92	92	92	92	92	92	92	92	92	92
Heavy Vehicles, %	2	2	2	2	2	2	2	2	2	2	2	2
Mvmt Flow	163	159	55	11	136	30	40	0	8	12	0	164

Major/Minor	Major1			Major2			Minor1			Minor2		
Conflicting Flow All	166	0	0	214	0	0	768	701	187	690	713	151
Stage 1	-	-	-	-	-	-	513	513	-	173	173	-
Stage 2	-	-	-	-	-	-	255	188	-	517	540	-
Critical Hdwy	4.12	-	-	4.12	-	-	7.12	6.52	6.22	7.12	6.52	6.22
Critical Hdwy Stg 1	-	-	-	-	-	-	6.12	5.52	-	6.12	5.52	-
Critical Hdwy Stg 2	-	-	-	-	-	-	6.12	5.52	-	6.12	5.52	-
Follow-up Hdwy	2.218	-	-	2.218	-	-	3.518	4.018	3.318	3.518	4.018	3.318
Pot Cap-1 Maneuver	1412	-	-	1379	-	-	326	368	937	374	361	895
Stage 1	-	-	-	-	-	-	564	541	-	829	756	-
Stage 2	-	-	-	-	-	-	749	745	-	560	524	-
Platoon blocked, %		-	-	1	-	-	1	1	1	1	1	
Mov Cap-1 Maneuver	1412	-	-	1379	-	-	242	323	937	336	317	895
Mov Cap-2 Maneuver	-	-	-	-	-	-	324	383	-	404	384	-
Stage 1	-	-	-	-	-	-	499	479	-	734	750	-
Stage 2	-	-	-	-	-	-	607	739	-	492	464	-

Approach	EB			WB			NB			SB		
HCM Control Delay, s	3.4			0.5			16.5			10.5		
HCM LOS							C			B		

Minor Lane/Major Mvmt	NBLn1	EBL	EBT	EBR	WBL	WBT	WBR	SBLn1
Capacity (veh/h)	362	1412	-	-	1379	-	-	827
HCM Lane V/C Ratio	0.132	0.115	-	-	0.008	-	-	0.213
HCM Control Delay (s)	16.5	7.9	-	-	7.6	-	-	10.5
HCM Lane LOS	C	A	-	-	A	-	-	B
HCM 95th %tile Q(veh)	0.5	0.4	-	-	0	-	-	0.8

Intersection												
Int Delay, s/veh	1.7											
Movement	EBL	EBT	EBR	WBL	WBT	WBR	NBL	NBT	NBR	SBL	SBT	SBR
Lane Configurations		↻			↻				↻			↻
Traffic Vol, veh/h	0	80	15	0	161	11	0	0	10	0	0	48
Future Vol, veh/h	0	80	15	0	161	11	0	0	10	0	0	48
Conflicting Peds, #/hr	0	0	0	0	0	0	0	0	0	0	0	0
Sign Control	Free	Free	Free	Free	Free	Free	Stop	Stop	Stop	Stop	Stop	Stop
RT Channelized	-	-	None	-	-	None	-	-	None	-	-	None
Storage Length	-	-	-	-	-	-	-	-	0	-	-	0
Veh in Median Storage, #	-	0	-	-	0	-	-	1	-	-	1	-
Grade, %	-	0	-	-	0	-	-	0	-	-	0	-
Peak Hour Factor	92	92	92	92	92	92	92	92	92	92	92	92
Heavy Vehicles, %	2	2	2	2	2	2	2	2	2	2	2	2
Mvmt Flow	0	87	16	0	175	12	0	0	11	0	0	52

Major/Minor	Major1		Major2		Minor1		Minor2					
Conflicting Flow All	-	0	0	-	-	0	-	-	95	-	-	181
Stage 1	-	-	-	-	-	-	-	-	-	-	-	-
Stage 2	-	-	-	-	-	-	-	-	-	-	-	-
Critical Hdwy	-	-	-	-	-	-	-	-	6.22	-	-	6.22
Critical Hdwy Stg 1	-	-	-	-	-	-	-	-	-	-	-	-
Critical Hdwy Stg 2	-	-	-	-	-	-	-	-	-	-	-	-
Follow-up Hdwy	-	-	-	-	-	-	-	-	3.318	-	-	3.318
Pot Cap-1 Maneuver	0	-	-	0	-	-	0	0	1002	0	0	862
Stage 1	0	-	-	0	-	-	0	0	-	0	0	-
Stage 2	0	-	-	0	-	-	0	0	-	0	0	-
Platoon blocked, %	-	-	-	-	-	-	-	-	1	-	-	-
Mov Cap-1 Maneuver	-	-	-	-	-	-	-	-	1002	-	-	862
Mov Cap-2 Maneuver	-	-	-	-	-	-	-	-	-	-	-	-
Stage 1	-	-	-	-	-	-	-	-	-	-	-	-
Stage 2	-	-	-	-	-	-	-	-	-	-	-	-

Approach	EB	WB	NB	SB
HCM Control Delay, s	0	0	8.6	9.4
HCM LOS			A	A

Minor Lane/Major Mvmt	NBLn1	EBT	EBR	WBT	WBR	SBLn1
Capacity (veh/h)	1002	-	-	-	-	862
HCM Lane V/C Ratio	0.011	-	-	-	-	0.061
HCM Control Delay (s)	8.6	-	-	-	-	9.4
HCM Lane LOS	A	-	-	-	-	A
HCM 95th %tile Q(veh)	0	-	-	-	-	0.2

Intersection												
Int Delay, s/veh	2.3											
Movement	EBL	EBT	EBR	WBL	WBT	WBR	NBL	NBT	NBR	SBL	SBT	SBR
Lane Configurations		↶			↶				↶			↶
Traffic Vol, veh/h	0	296	51	0	162	28	0	0	7	0	0	151
Future Vol, veh/h	0	296	51	0	162	28	0	0	7	0	0	151
Conflicting Peds, #/hr	0	0	0	0	0	0	0	0	0	0	0	0
Sign Control	Free	Free	Free	Free	Free	Free	Stop	Stop	Stop	Stop	Stop	Stop
RT Channelized	-	-	None	-	-	None	-	-	None	-	-	None
Storage Length	-	-	-	-	-	-	-	-	0	-	-	0
Veh in Median Storage, #	-	0	-	-	0	-	-	1	-	-	1	-
Grade, %	-	0	-	-	0	-	-	0	-	-	0	-
Peak Hour Factor	92	92	92	92	92	92	92	92	92	92	92	92
Heavy Vehicles, %	2	2	2	2	2	2	2	2	2	2	2	2
Mvmt Flow	0	322	55	0	176	30	0	0	8	0	0	164

Major/Minor	Major1		Major2		Minor1		Minor2					
Conflicting Flow All	-	0	0	-	-	0	-	-	350	-	-	191
Stage 1	-	-	-	-	-	-	-	-	-	-	-	-
Stage 2	-	-	-	-	-	-	-	-	-	-	-	-
Critical Hdwy	-	-	-	-	-	-	-	-	6.22	-	-	6.22
Critical Hdwy Stg 1	-	-	-	-	-	-	-	-	-	-	-	-
Critical Hdwy Stg 2	-	-	-	-	-	-	-	-	-	-	-	-
Follow-up Hdwy	-	-	-	-	-	-	-	-	3.318	-	-	3.318
Pot Cap-1 Maneuver	0	-	-	0	-	-	0	0	815	0	0	851
Stage 1	0	-	-	0	-	-	0	0	-	0	0	-
Stage 2	0	-	-	0	-	-	0	0	-	0	0	-
Platoon blocked, %		-	-	-	-	-			1			
Mov Cap-1 Maneuver	-	-	-	-	-	-	-	-	815	-	-	851
Mov Cap-2 Maneuver	-	-	-	-	-	-	-	-	-	-	-	-
Stage 1	-	-	-	-	-	-	-	-	-	-	-	-
Stage 2	-	-	-	-	-	-	-	-	-	-	-	-

Approach	EB	WB	NB	SB
HCM Control Delay, s	0	0	9.5	10.2
HCM LOS			A	B

Minor Lane/Major Mvmt	NBLn1	EBT	EBR	WBT	WBR	SBLn1
Capacity (veh/h)	815	-	-	-	-	851
HCM Lane V/C Ratio	0.009	-	-	-	-	0.193
HCM Control Delay (s)	9.5	-	-	-	-	10.2
HCM Lane LOS	A	-	-	-	-	B
HCM 95th %tile Q(veh)	0	-	-	-	-	0.7

Intersection												
Int Delay, s/veh	3.9											
Movement	EBL	EBT	EBR	WBL	WBT	WBR	NBL	NBT	NBR	SBL	SBT	SBR
Lane Configurations	↖	↗		↖	↗			↕			↕	
Traffic Vol, veh/h	13	73	15	3	119	11	51	0	10	18	0	48
Future Vol, veh/h	13	73	15	3	119	11	51	0	10	18	0	48
Conflicting Peds, #/hr	0	0	0	0	0	0	0	0	0	0	0	0
Sign Control	Free	Free	Free	Free	Free	Free	Stop	Stop	Stop	Stop	Stop	Stop
RT Channelized	-	-	None	-	-	None	-	-	None	-	-	None
Storage Length	75	-	-	50	-	-	-	-	-	-	-	-
Veh in Median Storage, #	-	0	-	-	0	-	-	1	-	-	1	-
Grade, %	-	0	-	-	0	-	-	0	-	-	0	-
Peak Hour Factor	92	92	92	92	92	92	92	92	92	92	92	92
Heavy Vehicles, %	2	2	2	2	2	2	2	2	2	2	2	2
Mvmt Flow	14	79	16	3	129	12	55	0	11	20	0	52

Major/Minor	Major1			Major2			Minor1			Minor2		
Conflicting Flow All	141	0	0	95	0	0	282	262	87	262	264	135
Stage 1	-	-	-	-	-	-	115	115	-	141	141	-
Stage 2	-	-	-	-	-	-	167	147	-	121	123	-
Critical Hdwy	4.12	-	-	4.12	-	-	7.12	6.52	6.22	7.12	6.52	6.22
Critical Hdwy Stg 1	-	-	-	-	-	-	6.12	5.52	-	6.12	5.52	-
Critical Hdwy Stg 2	-	-	-	-	-	-	6.12	5.52	-	6.12	5.52	-
Follow-up Hdwy	2.218	-	-	2.218	-	-	3.518	4.018	3.318	3.518	4.018	3.318
Pot Cap-1 Maneuver	1442	-	-	1514	-	-	700	663	1012	723	661	914
Stage 1	-	-	-	-	-	-	923	816	-	862	780	-
Stage 2	-	-	-	-	-	-	835	775	-	915	809	-
Platoon blocked, %		-	-	1	-	-	1	1	1	1	1	
Mov Cap-1 Maneuver	1442	-	-	1514	-	-	654	655	1012	708	653	914
Mov Cap-2 Maneuver	-	-	-	-	-	-	671	654	-	720	657	-
Stage 1	-	-	-	-	-	-	913	808	-	853	778	-
Stage 2	-	-	-	-	-	-	786	773	-	896	801	-

Approach	EB			WB			NB			SB		
HCM Control Delay, s	1			0.2			10.6			9.6		
HCM LOS							B			A		

Minor Lane/Major Mvmt	NBLn1	EBL	EBT	EBR	WBL	WBT	WBR	SBLn1
Capacity (veh/h)	710	1442	-	-	1514	-	-	851
HCM Lane V/C Ratio	0.093	0.01	-	-	0.002	-	-	0.084
HCM Control Delay (s)	10.6	7.5	-	-	7.4	-	-	9.6
HCM Lane LOS	B	A	-	-	A	-	-	A
HCM 95th %tile Q(veh)	0.3	0	-	-	0	-	-	0.3

Intersection												
Int Delay, s/veh	5											
Movement	EBL	EBT	EBR	WBL	WBT	WBR	NBL	NBT	NBR	SBL	SBT	SBR
Lane Configurations	↖	↗		↖	↗			↕			↕	
Traffic Vol, veh/h	150	160	51	10	137	28	37	0	7	11	0	151
Future Vol, veh/h	150	160	51	10	137	28	37	0	7	11	0	151
Conflicting Peds, #/hr	0	0	0	0	0	0	0	0	0	0	0	0
Sign Control	Free	Free	Free	Free	Free	Free	Stop	Stop	Stop	Stop	Stop	Stop
RT Channelized	-	-	None	-	-	None	-	-	None	-	-	None
Storage Length	75	-	-	50	-	-	-	-	-	-	-	-
Veh in Median Storage, #	-	0	-	-	0	-	-	1	-	-	1	-
Grade, %	-	0	-	-	0	-	-	0	-	-	0	-
Peak Hour Factor	92	92	92	92	92	92	92	92	92	92	92	92
Heavy Vehicles, %	2	2	2	2	2	2	2	2	2	2	2	2
Mvmt Flow	163	174	55	11	149	30	40	0	8	12	0	164

Major/Minor	Major1			Major2			Minor1			Minor2		
Conflicting Flow All	179	0	0	229	0	0	796	729	202	718	741	164
Stage 1	-	-	-	-	-	-	528	528	-	186	186	-
Stage 2	-	-	-	-	-	-	268	201	-	532	555	-
Critical Hdwy	4.12	-	-	4.12	-	-	7.12	6.52	6.22	7.12	6.52	6.22
Critical Hdwy Stg 1	-	-	-	-	-	-	6.12	5.52	-	6.12	5.52	-
Critical Hdwy Stg 2	-	-	-	-	-	-	6.12	5.52	-	6.12	5.52	-
Follow-up Hdwy	2.218	-	-	2.218	-	-	3.518	4.018	3.318	3.518	4.018	3.318
Pot Cap-1 Maneuver	1397	-	-	1361	-	-	310	353	917	356	347	881
Stage 1	-	-	-	-	-	-	552	531	-	816	746	-
Stage 2	-	-	-	-	-	-	738	735	-	549	515	-
Platoon blocked, %		-	-	1	-	-	1	1	1	1	1	
Mov Cap-1 Maneuver	1397	-	-	1361	-	-	228	309	917	319	304	881
Mov Cap-2 Maneuver	-	-	-	-	-	-	313	372	-	391	374	-
Stage 1	-	-	-	-	-	-	488	469	-	721	740	-
Stage 2	-	-	-	-	-	-	596	729	-	481	455	-

Approach	EB			WB			NB			SB		
HCM Control Delay, s	3.3			0.4			16.9			10.7		
HCM LOS							C			B		

Minor Lane/Major Mvmt	NBLn1	EBL	EBT	EBR	WBL	WBT	WBR	SBLn1
Capacity (veh/h)	350	1397	-	-	1361	-	-	812
HCM Lane V/C Ratio	0.137	0.117	-	-	0.008	-	-	0.217
HCM Control Delay (s)	16.9	7.9	-	-	7.7	-	-	10.7
HCM Lane LOS	C	A	-	-	A	-	-	B
HCM 95th %tile Q(veh)	0.5	0.4	-	-	0	-	-	0.8

Intersection												
Int Delay, s/veh	1.6											
Movement	EBL	EBT	EBR	WBL	WBT	WBR	NBL	NBT	NBR	SBL	SBT	SBR
Lane Configurations		↻			↻				↻			↻
Traffic Vol, veh/h	0	86	15	0	170	11	0	0	10	0	0	48
Future Vol, veh/h	0	86	15	0	170	11	0	0	10	0	0	48
Conflicting Peds, #/hr	0	0	0	0	0	0	0	0	0	0	0	0
Sign Control	Free	Free	Free	Free	Free	Free	Stop	Stop	Stop	Stop	Stop	Stop
RT Channelized	-	-	None	-	-	None	-	-	None	-	-	None
Storage Length	-	-	-	-	-	-	-	-	0	-	-	0
Veh in Median Storage, #	-	0	-	-	0	-	-	1	-	-	1	-
Grade, %	-	0	-	-	0	-	-	0	-	-	0	-
Peak Hour Factor	92	92	92	92	92	92	92	92	92	92	92	92
Heavy Vehicles, %	2	2	2	2	2	2	2	2	2	2	2	2
Mvmt Flow	0	93	16	0	185	12	0	0	11	0	0	52

Major/Minor	Major1		Major2		Minor1		Minor2					
Conflicting Flow All	-	0	0	-	-	0	-	-	101	-	-	191
Stage 1	-	-	-	-	-	-	-	-	-	-	-	-
Stage 2	-	-	-	-	-	-	-	-	-	-	-	-
Critical Hdwy	-	-	-	-	-	-	-	-	6.22	-	-	6.22
Critical Hdwy Stg 1	-	-	-	-	-	-	-	-	-	-	-	-
Critical Hdwy Stg 2	-	-	-	-	-	-	-	-	-	-	-	-
Follow-up Hdwy	-	-	-	-	-	-	-	-	3.318	-	-	3.318
Pot Cap-1 Maneuver	0	-	-	0	-	-	0	0	994	0	0	851
Stage 1	0	-	-	0	-	-	0	0	-	0	0	-
Stage 2	0	-	-	0	-	-	0	0	-	0	0	-
Platoon blocked, %		-	-	-	-	-			1			
Mov Cap-1 Maneuver	-	-	-	-	-	-	-	-	994	-	-	851
Mov Cap-2 Maneuver	-	-	-	-	-	-	-	-	-	-	-	-
Stage 1	-	-	-	-	-	-	-	-	-	-	-	-
Stage 2	-	-	-	-	-	-	-	-	-	-	-	-

Approach	EB	WB	NB	SB
HCM Control Delay, s	0	0	8.7	9.5
HCM LOS			A	A

Minor Lane/Major Mvmt	NBLn1	EBT	EBR	WBT	WBR	SBLn1
Capacity (veh/h)	994	-	-	-	-	851
HCM Lane V/C Ratio	0.011	-	-	-	-	0.061
HCM Control Delay (s)	8.7	-	-	-	-	9.5
HCM Lane LOS	A	-	-	-	-	A
HCM 95th %tile Q(veh)	0	-	-	-	-	0.2

Intersection												
Int Delay, s/veh	2.2											
Movement	EBL	EBT	EBR	WBL	WBT	WBR	NBL	NBT	NBR	SBL	SBT	SBR
Lane Configurations		↻			↻				↻			↻
Traffic Vol, veh/h	0	310	51	0	174	28	0	0	7	0	0	151
Future Vol, veh/h	0	310	51	0	174	28	0	0	7	0	0	151
Conflicting Peds, #/hr	0	0	0	0	0	0	0	0	0	0	0	0
Sign Control	Free	Free	Free	Free	Free	Free	Stop	Stop	Stop	Stop	Stop	Stop
RT Channelized	-	-	None	-	-	None	-	-	None	-	-	None
Storage Length	-	-	-	-	-	-	-	-	0	-	-	0
Veh in Median Storage, #	-	0	-	-	0	-	-	1	-	-	1	-
Grade, %	-	0	-	-	0	-	-	0	-	-	0	-
Peak Hour Factor	92	92	92	92	92	92	92	92	92	92	92	92
Heavy Vehicles, %	2	2	2	2	2	2	2	2	2	2	2	2
Mvmt Flow	0	337	55	0	189	30	0	0	8	0	0	164

Major/Minor	Major1		Major2		Minor1		Minor2					
Conflicting Flow All	-	0	0	-	-	0	-	-	365	-	-	204
Stage 1	-	-	-	-	-	-	-	-	-	-	-	-
Stage 2	-	-	-	-	-	-	-	-	-	-	-	-
Critical Hdwy	-	-	-	-	-	-	-	-	6.22	-	-	6.22
Critical Hdwy Stg 1	-	-	-	-	-	-	-	-	-	-	-	-
Critical Hdwy Stg 2	-	-	-	-	-	-	-	-	-	-	-	-
Follow-up Hdwy	-	-	-	-	-	-	-	-	3.318	-	-	3.318
Pot Cap-1 Maneuver	0	-	-	0	-	-	0	0	814	0	0	837
Stage 1	0	-	-	0	-	-	0	0	-	0	0	-
Stage 2	0	-	-	0	-	-	0	0	-	0	0	-
Platoon blocked, %		-	-	-	-	-			1			
Mov Cap-1 Maneuver	-	-	-	-	-	-	-	-	814	-	-	837
Mov Cap-2 Maneuver	-	-	-	-	-	-	-	-	-	-	-	-
Stage 1	-	-	-	-	-	-	-	-	-	-	-	-
Stage 2	-	-	-	-	-	-	-	-	-	-	-	-

Approach	EB		WB		NB		SB	
HCM Control Delay, s	0		0		9.5		10.3	
HCM LOS					A		B	

Minor Lane/Major Mvmt	NBLn1	EBT	EBR	WBT	WBR	SBLn1
Capacity (veh/h)	814	-	-	-	-	837
HCM Lane V/C Ratio	0.009	-	-	-	-	0.196
HCM Control Delay (s)	9.5	-	-	-	-	10.3
HCM Lane LOS	A	-	-	-	-	B
HCM 95th %tile Q(veh)	0	-	-	-	-	0.7

Intersection												
Int Delay, s/veh	2.9											
Movement	EBL	EBT	EBR	WBL	WBT	WBR	NBL	NBT	NBR	SBL	SBT	SBR
Lane Configurations	↖	↗		↖	↗			↕			↕	
Traffic Vol, veh/h	27	59	8	5	88	21	25	0	15	5	0	11
Future Vol, veh/h	27	59	8	5	88	21	25	0	15	5	0	11
Conflicting Peds, #/hr	0	0	0	0	0	0	0	0	0	0	0	0
Sign Control	Free	Free	Free	Free	Free	Free	Stop	Stop	Stop	Stop	Stop	Stop
RT Channelized	-	-	None	-	-	None	-	-	None	-	-	None
Storage Length	50	-	-	50	-	-	-	-	-	-	-	-
Veh in Median Storage, #	-	0	-	-	0	-	-	2	-	-	2	-
Grade, %	-	0	-	-	0	-	-	0	-	-	0	-
Peak Hour Factor	92	92	92	92	92	92	92	92	92	92	92	92
Heavy Vehicles, %	2	2	2	2	2	2	2	2	2	2	2	2
Mvmt Flow	29	64	9	5	96	23	27	0	16	5	0	12

Major/Minor	Major1			Major2			Minor1			Minor2		
Conflicting Flow All	119	0	0	73	0	0	251	256	69	253	249	108
Stage 1	-	-	-	-	-	-	127	127	-	118	118	-
Stage 2	-	-	-	-	-	-	124	129	-	135	131	-
Critical Hdwy	4.12	-	-	4.12	-	-	7.12	6.52	6.22	7.12	6.52	6.22
Critical Hdwy Stg 1	-	-	-	-	-	-	6.12	5.52	-	6.12	5.52	-
Critical Hdwy Stg 2	-	-	-	-	-	-	6.12	5.52	-	6.12	5.52	-
Follow-up Hdwy	2.218	-	-	2.218	-	-	3.518	4.018	3.318	3.518	4.018	3.318
Pot Cap-1 Maneuver	1469	-	-	1535	-	-	720	659	1017	718	665	946
Stage 1	-	-	-	-	-	-	893	799	-	887	798	-
Stage 2	-	-	-	-	-	-	880	789	-	884	796	-
Platoon blocked, %		-	-	1	-	-	1	1	1	1	1	
Mov Cap-1 Maneuver	1469	-	-	1535	-	-	698	644	1017	694	649	946
Mov Cap-2 Maneuver	-	-	-	-	-	-	761	690	-	762	702	-
Stage 1	-	-	-	-	-	-	875	783	-	869	796	-
Stage 2	-	-	-	-	-	-	866	787	-	853	780	-

Approach	EB			WB			NB			SB		
HCM Control Delay, s	2.2			0.3			9.5			9.2		
HCM LOS							A			A		

Minor Lane/Major Mvmt	NBLn1	EBL	EBT	EBR	WBL	WBT	WBR	SBLn1
Capacity (veh/h)	840	1469	-	-	1535	-	-	880
HCM Lane V/C Ratio	0.052	0.02	-	-	0.004	-	-	0.02
HCM Control Delay (s)	9.5	7.5	-	-	7.4	-	-	9.2
HCM Lane LOS	A	A	-	-	A	-	-	A
HCM 95th %tile Q(veh)	0.2	0.1	-	-	0	-	-	0.1

Intersection												
Int Delay, s/veh	3.8											
Movement	EBL	EBT	EBR	WBL	WBT	WBR	NBL	NBT	NBR	SBL	SBT	SBR
Lane Configurations	↖	↗		↖	↗			↕			↕	
Traffic Vol, veh/h	56	83	25	15	86	55	18	0	11	22	0	59
Future Vol, veh/h	56	83	25	15	86	55	18	0	11	22	0	59
Conflicting Peds, #/hr	0	0	0	0	0	0	0	0	0	0	0	0
Sign Control	Free	Free	Free	Free	Free	Free	Stop	Stop	Stop	Stop	Stop	Stop
RT Channelized	-	-	None	-	-	None	-	-	None	-	-	None
Storage Length	50	-	-	50	-	-	-	-	-	-	-	-
Veh in Median Storage, #	-	0	-	-	0	-	-	2	-	-	2	-
Grade, %	-	0	-	-	0	-	-	0	-	-	0	-
Peak Hour Factor	92	92	92	92	92	92	92	92	92	92	92	92
Heavy Vehicles, %	2	2	2	2	2	2	2	2	2	2	2	2
Mvmt Flow	61	90	27	16	93	60	20	0	12	24	0	64

Major/Minor	Major1			Major2			Minor1			Minor2		
Conflicting Flow All	153	0	0	117	0	0	413	411	104	387	394	123
Stage 1	-	-	-	-	-	-	226	226	-	155	155	-
Stage 2	-	-	-	-	-	-	187	185	-	232	239	-
Critical Hdwy	4.12	-	-	4.12	-	-	7.12	6.52	6.22	7.12	6.52	6.22
Critical Hdwy Stg 1	-	-	-	-	-	-	6.12	5.52	-	6.12	5.52	-
Critical Hdwy Stg 2	-	-	-	-	-	-	6.12	5.52	-	6.12	5.52	-
Follow-up Hdwy	2.218	-	-	2.218	-	-	3.518	4.018	3.318	3.518	4.018	3.318
Pot Cap-1 Maneuver	1428	-	-	1485	-	-	568	543	989	592	555	928
Stage 1	-	-	-	-	-	-	800	727	-	847	769	-
Stage 2	-	-	-	-	-	-	815	747	-	794	718	-
Platoon blocked, %		-	-	1	-	-	1	1	1	1	1	
Mov Cap-1 Maneuver	1428	-	-	1485	-	-	508	513	989	561	525	928
Mov Cap-2 Maneuver	-	-	-	-	-	-	616	597	-	661	610	-
Stage 1	-	-	-	-	-	-	765	696	-	811	761	-
Stage 2	-	-	-	-	-	-	751	739	-	751	687	-

Approach	EB			WB			NB			SB		
HCM Control Delay, s	2.6			0.7			10.2			9.8		
HCM LOS							B			A		

Minor Lane/Major Mvmt	NBLn1	EBL	EBT	EBR	WBL	WBT	WBR	SBLn1
Capacity (veh/h)	719	1428	-	-	1485	-	-	836
HCM Lane V/C Ratio	0.044	0.043	-	-	0.011	-	-	0.105
HCM Control Delay (s)	10.2	7.6	-	-	7.5	-	-	9.8
HCM Lane LOS	B	A	-	-	A	-	-	A
HCM 95th %tile Q(veh)	0.1	0.1	-	-	0	-	-	0.4

Intersection												
Int Delay, s/veh	5											
Movement	EBL	EBT	EBR	WBL	WBT	WBR	NBL	NBT	NBR	SBL	SBT	SBR
Lane Configurations	↖	↗		↖	↗			↕			↕	
Traffic Vol, veh/h	40	41	8	8	85	21	76	0	15	23	0	11
Future Vol, veh/h	40	41	8	8	85	21	76	0	15	23	0	11
Conflicting Peds, #/hr	0	0	0	0	0	0	0	0	0	0	0	0
Sign Control	Free	Free	Free	Free	Free	Free	Stop	Stop	Stop	Stop	Stop	Stop
RT Channelized	-	-	None	-	-	None	-	-	None	-	-	None
Storage Length	50	-	-	50	-	-	-	-	-	-	-	-
Veh in Median Storage, #	-	0	-	-	0	-	-	2	-	-	2	-
Grade, %	-	0	-	-	0	-	-	0	-	-	0	-
Peak Hour Factor	92	92	92	92	92	92	92	92	92	92	92	92
Heavy Vehicles, %	2	2	2	2	2	2	2	2	2	2	2	2
Mvmt Flow	43	45	9	9	92	23	83	0	16	25	0	12

Major/Minor	Major1			Major2			Minor1			Minor2		
Conflicting Flow All	115	0	0	54	0	0	264	269	50	266	262	104
Stage 1	-	-	-	-	-	-	136	136	-	122	122	-
Stage 2	-	-	-	-	-	-	128	133	-	144	140	-
Critical Hdwy	4.12	-	-	4.12	-	-	7.12	6.52	6.22	7.12	6.52	6.22
Critical Hdwy Stg 1	-	-	-	-	-	-	6.12	5.52	-	6.12	5.52	-
Critical Hdwy Stg 2	-	-	-	-	-	-	6.12	5.52	-	6.12	5.52	-
Follow-up Hdwy	2.218	-	-	2.218	-	-	3.518	4.018	3.318	3.518	4.018	3.318
Pot Cap-1 Maneuver	1474	-	-	1561	-	-	705	648	1043	704	654	951
Stage 1	-	-	-	-	-	-	884	792	-	882	795	-
Stage 2	-	-	-	-	-	-	876	786	-	875	788	-
Platoon blocked, %		-	-	1	-	-	1	1	1	1	1	
Mov Cap-1 Maneuver	1474	-	-	1561	-	-	678	625	1043	674	631	951
Mov Cap-2 Maneuver	-	-	-	-	-	-	742	673	-	745	687	-
Stage 1	-	-	-	-	-	-	858	769	-	856	790	-
Stage 2	-	-	-	-	-	-	860	781	-	836	765	-

Approach	EB			WB			NB			SB		
HCM Control Delay, s	3.4			0.5			10.3			9.7		
HCM LOS							B			A		

Minor Lane/Major Mvmt	NBLn1	EBL	EBT	EBR	WBL	WBT	WBR	SBLn1
Capacity (veh/h)	779	1474	-	-	1561	-	-	801
HCM Lane V/C Ratio	0.127	0.029	-	-	0.006	-	-	0.046
HCM Control Delay (s)	10.3	7.5	-	-	7.3	-	-	9.7
HCM Lane LOS	B	A	-	-	A	-	-	A
HCM 95th %tile Q(veh)	0.4	0.1	-	-	0	-	-	0.1

Intersection												
Int Delay, s/veh	6.3											
Movement	EBL	EBT	EBR	WBL	WBT	WBR	NBL	NBT	NBR	SBL	SBT	SBR
Lane Configurations	↖	↗		↖	↗			↕			↕	
Traffic Vol, veh/h	206	72	25	25	76	55	55	0	11	33	0	59
Future Vol, veh/h	206	72	25	25	76	55	55	0	11	33	0	59
Conflicting Peds, #/hr	0	0	0	0	0	0	0	0	0	0	0	0
Sign Control	Free	Free	Free	Free	Free	Free	Stop	Stop	Stop	Stop	Stop	Stop
RT Channelized	-	-	None	-	-	None	-	-	None	-	-	None
Storage Length	50	-	-	50	-	-	-	-	-	-	-	-
Veh in Median Storage, #	-	0	-	-	0	-	-	2	-	-	2	-
Grade, %	-	0	-	-	0	-	-	0	-	-	0	-
Peak Hour Factor	92	92	92	92	92	92	92	92	92	92	92	92
Heavy Vehicles, %	2	2	2	2	2	2	2	2	2	2	2	2
Mvmt Flow	224	78	27	27	83	60	60	0	12	36	0	64

Major/Minor	Major1			Major2			Minor1			Minor2		
Conflicting Flow All	143	0	0	105	0	0	739	737	92	713	720	113
Stage 1	-	-	-	-	-	-	540	540	-	167	167	-
Stage 2	-	-	-	-	-	-	199	197	-	546	553	-
Critical Hdwy	4.12	-	-	4.12	-	-	7.12	6.52	6.22	7.12	6.52	6.22
Critical Hdwy Stg 1	-	-	-	-	-	-	6.12	5.52	-	6.12	5.52	-
Critical Hdwy Stg 2	-	-	-	-	-	-	6.12	5.52	-	6.12	5.52	-
Follow-up Hdwy	2.218	-	-	2.218	-	-	3.518	4.018	3.318	3.518	4.018	3.318
Pot Cap-1 Maneuver	1440	-	-	1501	-	-	336	347	1005	351	355	940
Stage 1	-	-	-	-	-	-	532	522	-	835	760	-
Stage 2	-	-	-	-	-	-	803	738	-	527	514	-
Platoon blocked, %		-	-	1	-	-	1	1	1	1	1	
Mov Cap-1 Maneuver	1440	-	-	1501	-	-	272	287	1005	302	294	940
Mov Cap-2 Maneuver	-	-	-	-	-	-	386	384	-	386	381	-
Stage 1	-	-	-	-	-	-	449	440	-	705	746	-
Stage 2	-	-	-	-	-	-	735	725	-	440	434	-

Approach	EB			WB			NB			SB		
HCM Control Delay, s	5.4			1.2			15			11.9		
HCM LOS							C			B		

Minor Lane/Major Mvmt	NBLn1	EBL	EBT	EBR	WBL	WBT	WBR	SBLn1
Capacity (veh/h)	430	1440	-	-	1501	-	-	621
HCM Lane V/C Ratio	0.167	0.155	-	-	0.018	-	-	0.161
HCM Control Delay (s)	15	8	-	-	7.4	-	-	11.9
HCM Lane LOS	C	A	-	-	A	-	-	B
HCM 95th %tile Q(veh)	0.6	0.6	-	-	0.1	-	-	0.6

Intersection												
Int Delay, s/veh	2.7											
Movement	EBL	EBT	EBR	WBL	WBT	WBR	NBL	NBT	NBR	SBL	SBT	SBR
Lane Configurations	↖	↗		↖	↗			↕			↕	
Traffic Vol, veh/h	27	65	8	5	97	21	25	0	15	5	0	11
Future Vol, veh/h	27	65	8	5	97	21	25	0	15	5	0	11
Conflicting Peds, #/hr	0	0	0	0	0	0	0	0	0	0	0	0
Sign Control	Free	Free	Free	Free	Free	Free	Stop	Stop	Stop	Stop	Stop	Stop
RT Channelized	-	-	None	-	-	None	-	-	None	-	-	None
Storage Length	50	-	-	50	-	-	-	-	-	-	-	-
Veh in Median Storage, #	-	0	-	-	0	-	-	2	-	-	2	-
Grade, %	-	0	-	-	0	-	-	0	-	-	0	-
Peak Hour Factor	92	92	92	92	92	92	92	92	92	92	92	92
Heavy Vehicles, %	2	2	2	2	2	2	2	2	2	2	2	2
Mvmt Flow	29	71	9	5	105	23	27	0	16	5	0	12

Major/Minor	Major1			Major2			Minor1			Minor2		
Conflicting Flow All	128	0	0	80	0	0	267	272	76	269	265	117
Stage 1	-	-	-	-	-	-	134	134	-	127	127	-
Stage 2	-	-	-	-	-	-	133	138	-	142	138	-
Critical Hdwy	4.12	-	-	4.12	-	-	7.12	6.52	6.22	7.12	6.52	6.22
Critical Hdwy Stg 1	-	-	-	-	-	-	6.12	5.52	-	6.12	5.52	-
Critical Hdwy Stg 2	-	-	-	-	-	-	6.12	5.52	-	6.12	5.52	-
Follow-up Hdwy	2.218	-	-	2.218	-	-	3.518	4.018	3.318	3.518	4.018	3.318
Pot Cap-1 Maneuver	1458	-	-	1534	-	-	717	654	1027	714	660	935
Stage 1	-	-	-	-	-	-	900	800	-	877	791	-
Stage 2	-	-	-	-	-	-	870	782	-	891	797	-
Platoon blocked, %		-	-	1	-	-	1	1	1	1	1	
Mov Cap-1 Maneuver	1458	-	-	1534	-	-	695	639	1027	691	645	935
Mov Cap-2 Maneuver	-	-	-	-	-	-	757	686	-	761	699	-
Stage 1	-	-	-	-	-	-	882	784	-	859	789	-
Stage 2	-	-	-	-	-	-	856	780	-	860	781	-

Approach	EB			WB			NB			SB		
HCM Control Delay, s	2			0.3			9.5			9.2		
HCM LOS							A			A		

Minor Lane/Major Mvmt	NBLn1	EBL	EBT	EBR	WBL	WBT	WBR	SBLn1
Capacity (veh/h)	840	1458	-	-	1534	-	-	873
HCM Lane V/C Ratio	0.052	0.02	-	-	0.004	-	-	0.02
HCM Control Delay (s)	9.5	7.5	-	-	7.4	-	-	9.2
HCM Lane LOS	A	A	-	-	A	-	-	A
HCM 95th %tile Q(veh)	0.2	0.1	-	-	0	-	-	0.1

Intersection												
Int Delay, s/veh	3.7											
Movement	EBL	EBT	EBR	WBL	WBT	WBR	NBL	NBT	NBR	SBL	SBT	SBR
Lane Configurations	↖	↗		↖	↗			↕			↕	
Traffic Vol, veh/h	56	91	25	15	94	55	18	0	11	22	0	59
Future Vol, veh/h	56	91	25	15	94	55	18	0	11	22	0	59
Conflicting Peds, #/hr	0	0	0	0	0	0	0	0	0	0	0	0
Sign Control	Free	Free	Free	Free	Free	Free	Stop	Stop	Stop	Stop	Stop	Stop
RT Channelized	-	-	None	-	-	None	-	-	None	-	-	None
Storage Length	50	-	-	50	-	-	-	-	-	-	-	-
Veh in Median Storage, #	-	0	-	-	0	-	-	2	-	-	2	-
Grade, %	-	0	-	-	0	-	-	0	-	-	0	-
Peak Hour Factor	92	92	92	92	92	92	92	92	92	92	92	92
Heavy Vehicles, %	2	2	2	2	2	2	2	2	2	2	2	2
Mvmt Flow	61	99	27	16	102	60	20	0	12	24	0	64

Major/Minor	Major1			Major2			Minor1			Minor2		
Conflicting Flow All	162	0	0	126	0	0	431	429	113	405	412	132
Stage 1	-	-	-	-	-	-	235	235	-	164	164	-
Stage 2	-	-	-	-	-	-	196	194	-	241	248	-
Critical Hdwy	4.12	-	-	4.12	-	-	7.12	6.52	6.22	7.12	6.52	6.22
Critical Hdwy Stg 1	-	-	-	-	-	-	6.12	5.52	-	6.12	5.52	-
Critical Hdwy Stg 2	-	-	-	-	-	-	6.12	5.52	-	6.12	5.52	-
Follow-up Hdwy	2.218	-	-	2.218	-	-	3.518	4.018	3.318	3.518	4.018	3.318
Pot Cap-1 Maneuver	1417	-	-	1481	-	-	562	535	997	586	548	917
Stage 1	-	-	-	-	-	-	802	726	-	838	762	-
Stage 2	-	-	-	-	-	-	806	740	-	796	716	-
Platoon blocked, %		-	-	1	-	-	1	1	1	1	1	
Mov Cap-1 Maneuver	1417	-	-	1481	-	-	501	506	997	555	518	917
Mov Cap-2 Maneuver	-	-	-	-	-	-	610	592	-	658	606	-
Stage 1	-	-	-	-	-	-	767	695	-	802	754	-
Stage 2	-	-	-	-	-	-	742	732	-	753	685	-

Approach	EB			WB			NB			SB		
HCM Control Delay, s	2.5			0.7			10.3			9.9		
HCM LOS							B			A		

Minor Lane/Major Mvmt	NBLn1	EBL	EBT	EBR	WBL	WBT	WBR	SBLn1
Capacity (veh/h)	715	1417	-	-	1481	-	-	828
HCM Lane V/C Ratio	0.044	0.043	-	-	0.011	-	-	0.106
HCM Control Delay (s)	10.3	7.7	-	-	7.5	-	-	9.9
HCM Lane LOS	B	A	-	-	A	-	-	A
HCM 95th %tile Q(veh)	0.1	0.1	-	-	0	-	-	0.4

Intersection												
Int Delay, s/veh	4.8											
Movement	EBL	EBT	EBR	WBL	WBT	WBR	NBL	NBT	NBR	SBL	SBT	SBR
Lane Configurations	↖	↗		↖	↗			↕			↕	
Traffic Vol, veh/h	40	47	8	8	94	21	76	0	15	23	0	11
Future Vol, veh/h	40	47	8	8	94	21	76	0	15	23	0	11
Conflicting Peds, #/hr	0	0	0	0	0	0	0	0	0	0	0	0
Sign Control	Free	Free	Free	Free	Free	Free	Stop	Stop	Stop	Stop	Stop	Stop
RT Channelized	-	-	None	-	-	None	-	-	None	-	-	None
Storage Length	50	-	-	50	-	-	-	-	-	-	-	-
Veh in Median Storage, #	-	0	-	-	0	-	-	2	-	-	2	-
Grade, %	-	0	-	-	0	-	-	0	-	-	0	-
Peak Hour Factor	92	92	92	92	92	92	92	92	92	92	92	92
Heavy Vehicles, %	2	2	2	2	2	2	2	2	2	2	2	2
Mvmt Flow	43	51	9	9	102	23	83	0	16	25	0	12

Major/Minor	Major1		Major2		Minor1			Minor2				
Conflicting Flow All	125	0	0	60	0	0	280	285	56	282	278	114
Stage 1	-	-	-	-	-	-	142	142	-	132	132	-
Stage 2	-	-	-	-	-	-	138	143	-	150	146	-
Critical Hdwy	4.12	-	-	4.12	-	-	7.12	6.52	6.22	7.12	6.52	6.22
Critical Hdwy Stg 1	-	-	-	-	-	-	6.12	5.52	-	6.12	5.52	-
Critical Hdwy Stg 2	-	-	-	-	-	-	6.12	5.52	-	6.12	5.52	-
Follow-up Hdwy	2.218	-	-	2.218	-	-	3.518	4.018	3.318	3.518	4.018	3.318
Pot Cap-1 Maneuver	1462	-	-	1553	-	-	689	634	1034	686	640	939
Stage 1	-	-	-	-	-	-	877	787	-	871	787	-
Stage 2	-	-	-	-	-	-	865	779	-	868	784	-
Platoon blocked, %		-	-	1	-	-	1	1	1	1	1	
Mov Cap-1 Maneuver	1462	-	-	1553	-	-	662	612	1034	657	618	939
Mov Cap-2 Maneuver	-	-	-	-	-	-	731	665	-	734	680	-
Stage 1	-	-	-	-	-	-	851	764	-	846	782	-
Stage 2	-	-	-	-	-	-	849	774	-	829	762	-

Approach	EB		WB		NB		SB	
HCM Control Delay, s	3.2		0.5		10.4		9.8	
HCM LOS					B		A	

Minor Lane/Major Mvmt	NBLn1	EBL	EBT	EBR	WBL	WBT	WBR	SBLn1
Capacity (veh/h)	768	1462	-	-	1553	-	-	790
HCM Lane V/C Ratio	0.129	0.03	-	-	0.006	-	-	0.047
HCM Control Delay (s)	10.4	7.5	-	-	7.3	-	-	9.8
HCM Lane LOS	B	A	-	-	A	-	-	A
HCM 95th %tile Q(veh)	0.4	0.1	-	-	0	-	-	0.1

Intersection												
Int Delay, s/veh	6.2											
Movement	EBL	EBT	EBR	WBL	WBT	WBR	NBL	NBT	NBR	SBL	SBT	SBR
Lane Configurations	↖	↗		↖	↗			↕			↕	
Traffic Vol, veh/h	206	80	25	25	84	55	55	0	11	33	0	59
Future Vol, veh/h	206	80	25	25	84	55	55	0	11	33	0	59
Conflicting Peds, #/hr	0	0	0	0	0	0	0	0	0	0	0	0
Sign Control	Free	Free	Free	Free	Free	Free	Stop	Stop	Stop	Stop	Stop	Stop
RT Channelized	-	-	None	-	-	None	-	-	None	-	-	None
Storage Length	50	-	-	50	-	-	-	-	-	-	-	-
Veh in Median Storage, #	-	0	-	-	0	-	-	2	-	-	2	-
Grade, %	-	0	-	-	0	-	-	0	-	-	0	-
Peak Hour Factor	92	92	92	92	92	92	92	92	92	92	92	92
Heavy Vehicles, %	2	2	2	2	2	2	2	2	2	2	2	2
Mvmt Flow	224	87	27	27	91	60	60	0	12	36	0	64

Major/Minor	Major1			Major2			Minor1			Minor2		
Conflicting Flow All	151	0	0	114	0	0	756	754	101	730	737	121
Stage 1	-	-	-	-	-	-	549	549	-	175	175	-
Stage 2	-	-	-	-	-	-	207	205	-	555	562	-
Critical Hdwy	4.12	-	-	4.12	-	-	7.12	6.52	6.22	7.12	6.52	6.22
Critical Hdwy Stg 1	-	-	-	-	-	-	6.12	5.52	-	6.12	5.52	-
Critical Hdwy Stg 2	-	-	-	-	-	-	6.12	5.52	-	6.12	5.52	-
Follow-up Hdwy	2.218	-	-	2.218	-	-	3.518	4.018	3.318	3.518	4.018	3.318
Pot Cap-1 Maneuver	1430	-	-	1489	-	-	328	339	994	342	347	930
Stage 1	-	-	-	-	-	-	526	516	-	827	754	-
Stage 2	-	-	-	-	-	-	795	732	-	522	509	-
Platoon blocked, %		-	-	1	-	-	1	1	1	1	1	
Mov Cap-1 Maneuver	1430	-	-	1489	-	-	265	281	994	293	287	930
Mov Cap-2 Maneuver	-	-	-	-	-	-	379	379	-	381	376	-
Stage 1	-	-	-	-	-	-	443	435	-	697	740	-
Stage 2	-	-	-	-	-	-	727	719	-	435	429	-

Approach	EB			WB			NB			SB		
HCM Control Delay, s	5.3			1.1			15.2			12		
HCM LOS							C			B		

Minor Lane/Major Mvmt	NBLn1	EBL	EBT	EBR	WBL	WBT	WBR	SBLn1
Capacity (veh/h)	423	1430	-	-	1489	-	-	613
HCM Lane V/C Ratio	0.17	0.157	-	-	0.018	-	-	0.163
HCM Control Delay (s)	15.2	8	-	-	7.5	-	-	12
HCM Lane LOS	C	A	-	-	A	-	-	B
HCM 95th %tile Q(veh)	0.6	0.6	-	-	0.1	-	-	0.6

APPENDIX E

Signal Timings

Intersection 539 at North Gate Rd and Voyager Pkwy - Timing table

Page 1	Phases											
	1	2	3	4	5	6	7	8	9	10	11	12
Min Green	4	10	4	4	4	10	4	4	0	0	0	0
Passage Time I	2.0	3.0	2.0	3.0	2.0	3.0	2.0	3.0	0.0	0.0	0.0	0.0
Passage Time II	0.0	0.0	0.0	0.0	0.0	0.0	0.0	0.0	0.0	0.0	0.0	0.0
Max Green I	10	40	10	20	10	40	15	20	0	0	0	0
Max Green II	15	40	10	20	10	40	30	20	0	0	0	0
Yellow Clearance	3.0	5.0	3.0	5.0	3.0	5.0	3.0	5.0	0.0	0.0	0.0	0.0
Red Clearance	2.0	2.0	2.0	2.0	2.0	2.0	2.0	2.0	0.0	0.0	0.0	0.0
Added Initial	0.0	0.0	0.0	0.0	0.0	0.0	0.0	0.0	0.0	0.0	0.0	0.0
Max Added Initial	0	0	0	0	0	0	0	0	0	0	0	0
Time Before Reduction	0	0	0	0	0	0	0	0	0	0	0	0
Cars Before Reduction	0	0	0	0	0	0	0	0	0	0	0	0
Time To Reduce	0	0	0	0	0	0	0	0	0	0	0	0
Min Passage	0.0	0.0	0.0	0.0	0.0	0.0	0.0	0.0	0.0	0.0	0.0	0.0
Recall Green Time	0	0	0	0	0	0	0	0	0	0	0	0
Red Revert Time	0.0	0.0	0.0	0.0	0.0	0.0	0.0	0.0	0.0	0.0	0.0	0.0
Walk Time	0	7	0	7	0	7	0	7	0	0	0	0
Pedestrian Clearance	0	30	0	25	0	30	0	25	0	0	0	0
Handicap Walk	0	0	0	0	0	0	0	0	0	0	0	0
Handicap Ped Clearance	0	0	0	0	0	0	0	0	0	0	0	0
North Gate Rd	X	X			X	X						
Voyager Pkwy			X	X			X	X				
Compass Direction	W	E	S	N	E	W	N	S				
Through, Turn or XPed	Left,p/p	Thru	Left,p/p	Thru	Left,p/p	Thru	Left,prt	Thru				

Intersection 539 at North Gate Rd and Voyager Pkwy - Sequence table

Page 1	Ring 1 Phases				Ring 2 Phases				Ring 3 Phases			
	1	2	3	4	5	6	7	8	9	10	11	12
State 1	Vehicle				Vehicle							
Barrier 1												
State 2		V & P				V & P						
Barrier 2	XXXXXXXXXXXXXXXXXXXXXXXXXX				XXXXXXXXXXXXXXXXXXXXXXXXXX							
State 3			Vehicle				Vehicle					
Barrier 3												
State 4				V & P				V & P				
Barrier 4	XXXXXXXXXXXXXXXXXXXXXXXXXX				XXXXXXXXXXXXXXXXXXXXXXXXXX							
State 5												
Barrier 5												
State 6												
Barrier 6												
State 7												
Barrier 7												
State 8												
Barrier 8												
State 9												
Barrier 9												
State 10												
Barrier 10												
State 11												
Barrier 11												
State 12												
Barrier 12												

Intersection 539 at North Gate Rd and Voyager Pkwy - schedule table

Event Num	Enabled	Event Type	Event Parameters		Start					Duration Minutes	Stop		Repetition		Priority
			Param 1	Param 2	Mon	Day	Hour	Min	Sec		Mon	Day	Repeat	Intervals	
1	No	Use Max Green II			1	1	07	15	00	60	12	31	Weekly	MTWTF	Medium
2	Yes	Run Plan	Plan 1	Ofst #1	1	1	07	00	00	720	12	31	Weekly	SMTWTFS	Medium
3															
4															
5															
6															
7															
8															
9															
10															
11															
12															
13															
14															
15															
16															
17															
18															
19															
20															
21															
22															
23															
24															
25															

Intersection 539 at North Gate Rd and Voyager Pkwy - Coordination table

Plan 1	111	Cycle Length	120	Phases	Splits	Alternate Mins	Alternate Passages	Alternate Maxes
	123456789012	Offset 1	22					
Coordinated Phases		Offset 2	0	1	25	0	0.0	27
	2 6	Offset 3	0	2	44	0	0.0	49
Secondary Coordinated Phases		Offset 4	0	3	17	0	0.0	17
		Relative Secondary Offset	0	4	34	0	0.0	36
Extra Time Phases		Permissive Period	Auto	5	15	0	0.0	14
		Max Cycle Addition	30	6	54	0	0.0	61
Additional Max Recalls		Max Cycle Subtraction	30	7	25	0	0.0	27
		Coord Actuated Period	0	8	26	0	0.0	26
Units	Seconds	Top Of Cycle Green Point	End	9	0	0	0.0	0
		Big Bang Preempt Recvry	No	10	0	0	0.0	0
		Big Bang Ped Recovery	No	11	0	0	0.0	0
		Min Lagging Left Split	0%	12	0	0	0.0	0
Plan 2	111	Cycle Length	0	Phases	Splits	Alternate Mins	Alternate Passages	Alternate Maxes
	123456789012	Offset 1	0					
Coordinated Phases		Offset 2	0	1	0	0	0.0	0
		Offset 3	0	2	0	0	0.0	0
Secondary Coordinated Phases		Offset 4	0	3	0	0	0.0	0
		Relative Secondary Offset	0	4	0	0	0.0	0
Extra Time Phases		Permissive Period	Auto	5	0	0	0.0	0
		Max Cycle Addition	0	6	0	0	0.0	0
Additional Max Recalls		Max Cycle Subtraction	0	7	0	0	0.0	0
		Coord Actuated Period	0	8	0	0	0.0	0
Units	Seconds	Top Of Cycle Green Point	End	9	0	0	0.0	0
		Big Bang Preempt Recvry	No	10	0	0	0.0	0
		Big Bang Ped Recovery	No	11	0	0	0.0	0
		Min Lagging Left Split	0%	12	0	0	0.0	0

Intersection 620 at Voyager Pkwy and Spectrum Loop North - Timing table

Page 1	Phases											
	1	2	3	4	5	6	7	8	9	10	11	12
Min Green	4	23	0	4	4	23	0	4	0	0	0	0
Passage Time I	2.0	2.0	0.0	1.5	2.0	2.0	0.0	1.5	0.0	0.0	0.0	0.0
Passage Time II	0.0	0.0	0.0	0.0	0.0	0.0	0.0	0.0	0.0	0.0	0.0	0.0
Max Green I	10	35	0	12	10	35	0	12	0	0	0	0
Max Green II	0	0	0	0	0	0	0	0	0	0	0	0
Yellow Clearance	3.0	4.5	0.0	4.5	3.0	4.5	0.0	4.5	0.0	0.0	0.0	0.0
Red Clearance	2.0	2.0	0.0	2.0	2.0	2.0	0.0	2.0	0.0	0.0	0.0	0.0
Added Initial	0.0	0.0	0.0	0.0	0.0	0.0	0.0	0.0	0.0	0.0	0.0	0.0
Max Added Initial	0	0	0	0	0	0	0	0	0	0	0	0
Time Before Reduction	0	0	0	0	0	0	0	0	0	0	0	0
Cars Before Reduction	0	0	0	0	0	0	0	0	0	0	0	0
Time To Reduce	0	0	0	0	0	0	0	0	0	0	0	0
Min Passage	0.0	0.0	0.0	0.0	0.0	0.0	0.0	0.0	0.0	0.0	0.0	0.0
Recall Green Time	0	0	0	0	0	0	0	0	0	0	0	0
Red Revert Time	0.0	0.0	0.0	0.0	0.0	0.0	0.0	0.0	0.0	0.0	0.0	0.0
Walk Time	0	7	0	0	0	7	0	7	0	0	0	0
Pedestrian Clearance	0	24	0	0	0	24	0	24	0	0	0	0
Handicap Walk	0	0	0	0	0	0	0	0	0	0	0	0
Handicap Ped Clearance	0	0	0	0	0	0	0	0	0	0	0	0
Voyager Pkwy	X	X			X	X						
Spectrum Loop North				X				X				
Compass Direction	S	N		E	N	S		W				
Through, Turn or XPed	Left,prt	Thru		Thru	Left,prt	Thru		Thru				

Intersection 620 at Voyager Pkwy and Spectrum Loop North - Sequence table

Page 1	Ring 1 Phases				Ring 2 Phases				Ring 3 Phases			
	1	2	3	4	5	6	7	8	9	10	11	12
State 1	Vehicle				Vehicle							
Barrier 1												
State 2		V & P				V & P						
Barrier 2	XXXXXXXXXXXXXXXXXXXXXXXXXX				XXXXXXXXXXXXXXXXXXXXXXXXXX							
State 3				Vehicle				V & P				
Barrier 3	XXXXXXXXXXXXXXXXXXXXXXXXXX				XXXXXXXXXXXXXXXXXXXXXXXXXX							
State 4												
Barrier 4												
State 5												
Barrier 5												
State 6												
Barrier 6												
State 7												
Barrier 7												
State 8												
Barrier 8												
State 9												
Barrier 9												
State 10												
Barrier 10												
State 11												
Barrier 11												
State 12												
Barrier 12												

Intersection 620 at Voyager Pkwy and Spectrum Loop North - schedule table

Event Num	Ena- bled	Event Type	Event Parameters		Start					Duration Minutes	Stop		Repetition		Priority
			Param 1	Param 2	Mon	Day	Hour	Min	Sec		Mon	Day	Repeat	Intervals	
1															
2															
3	Yes	Run Plan	Plan 5	Ofst #1	1	1	06	30	00	720	12	31	Weekly	MTWTF	Low
4															
5															
6															
7															
8															
9															
10															
11															
12															
13															
14															
15															
16															
17															
18															
19															
20															
21															
22															
23															
24															
25															

Intersection 620 at Voyager Pkwy and Spectrum Loop North - Coordination table

Plan 5	111	Cycle Length	138	Phases	Splits	Alternate Mins	Alternate Passages	Alternate Maxes
	123456789012	Offset 1	75					
Coordinated Phases		Offset 2	44	1	16	0	0.0	16
	2 6	Offset 3	0	2	85	0	0.0	99
Secondary Coordinated Phases		Offset 4	0	3	0	0	0.0	0
		Relative Secondary Offset	0	4	37	0	0.0	40
Extra Time Phases		Permissive Period	Auto	5	16	0	0.0	16
		Max Cycle Addition	34	6	85	0	0.0	99
Additional Max Recalls		Max Cycle Subtraction	34	7	0	0	0.0	0
		Coord Actuated Period	0	8	37	0	0.0	40
Units	Seconds	Top Of Cycle Green Point	End	9	0	0	0.0	0
		Big Bang Preempt Recvry	No	10	0	0	0.0	0
		Big Bang Ped Recovery	No	11	0	0	0.0	0
		Min Lagging Left Split	0%	12	0	0	0.0	0
Plan 6	111	Cycle Length	0	Phases	Splits	Alternate Mins	Alternate Passages	Alternate Maxes
	123456789012	Offset 1	0					
Coordinated Phases		Offset 2	0	1	0	0	0.0	0
		Offset 3	0	2	0	0	0.0	0
Secondary Coordinated Phases		Offset 4	0	3	0	0	0.0	0
		Relative Secondary Offset	0	4	0	0	0.0	0
Extra Time Phases		Permissive Period	Auto	5	0	0	0.0	0
		Max Cycle Addition	0	6	0	0	0.0	0
Additional Max Recalls		Max Cycle Subtraction	0	7	0	0	0.0	0
		Coord Actuated Period	0	8	0	0	0.0	0
Units	Seconds	Top Of Cycle Green Point	End	9	0	0	0.0	0
		Big Bang Preempt Recvry	No	10	0	0	0.0	0
		Big Bang Ped Recovery	No	11	0	0	0.0	0
		Min Lagging Left Split	0%	12	0	0	0.0	0

Intersection 640 at Voyager Pkwy and Powers Blvd Northbound - Timing table, page 1

Page 1	Phases											
	1	2	3	4	5	6	7	8	9	10	11	12
Min Green	0	4	0	4	4	4	0	0	0	0	0	0
Passage Time I	0.0	2.0	0.0	2.0	2.0	2.0	0.0	0.0	0.0	0.0	0.0	0.0
Passage Time II	0.0	2.0	0.0	2.0	2.0	2.0	0.0	0.0	0.0	0.0	0.0	0.0
Max Green I	0	30	0	30	30	30	0	0	0	0	0	0
Max Green II	0	30	0	30	30	30	0	0	0	0	0	0
Yellow Clearance	0.0	4.0	0.0	4.0	3.0	4.0	0.0	0.0	0.0	0.0	0.0	0.0
Red Clearance	0.0	2.0	0.0	2.0	2.0	2.0	0.0	0.0	0.0	0.0	0.0	0.0
Added Initial	0.0	0.0	0.0	0.0	0.0	0.0	0.0	0.0	0.0	0.0	0.0	0.0
Max Added Initial	0	0	0	0	0	0	0	0	0	0	0	0
Time Before Reduction	0	0	0	0	0	0	0	0	0	0	0	0
Cars Before Reduction	0	0	0	0	0	0	0	0	0	0	0	0
Time To Reduce	0	0	0	0	0	0	0	0	0	0	0	0
Min Passage	0.0	0.0	0.0	0.0	0.0	0.0	0.0	0.0	0.0	0.0	0.0	0.0
Recall Green Time	0	0	0	0	0	0	0	0	0	0	0	0
Red Revert Time	0.0	0.0	0.0	0.0	0.0	0.0	0.0	0.0	0.0	0.0	0.0	0.0
Walk Time	0	0	0	0	0	7	0	0	0	0	0	0
Pedestrian Clearance	0	0	0	0	0	18	0	0	0	0	0	0
Handicap Walk	0	0	0	0	0	0	0	0	0	0	0	0
Handicap Ped Clearance	0	0	0	0	0	0	0	0	0	0	0	0
Voyager Pkwy		X			X	X						
Powers Blvd Northbound												
Compass Direction		N			N	S						
Through, Turn or XPed		Thru			Left,prt	Thru						

Intersection 640 at Voyager Pkwy and Powers Blvd Northbound - Sequence table, page 1

Page 1	Ring 1 Phases				Ring 2 Phases				Ring 3 Phases			
	1	2	3	4	5	6	7	8	9	10	11	12
State 1					Vehicle							
Barrier 1												
State 2		Vehicle				V & P						
Barrier 2	XXXXXXXXXXXXXXXXXXXXXXXXXX				XXXXXXXXXXXXXXXXXXXXXXXXXX							
State 3												
Barrier 3												
State 4												
Barrier 4												
State 5												
Barrier 5												
State 6												
Barrier 6												
State 7												
Barrier 7												
State 8												
Barrier 8												
State 9												
Barrier 9												
State 10												
Barrier 10												
State 11												
Barrier 11												
State 12												
Barrier 12												

Intersection 640 at Voyager Pkwy and Powers Blvd Northbound - Phases control table, page 1

Page 1	Vehicle Phases		Ped Phases
	111 123456789012		111 123456789012
Min Recalls		Ped Recalls	
Max Recalls	2 6	Handicap Ped Recalls	
Recall If Maxed		Soft Ped Recalls	
Dual Entry		Do Not Recall Ped	2 4 6 8
Do Not Skip		Allow Walk Reduction	
Simultaneous Gap Out		Hold In Walk	
Restricted Phases		Allow Ped Re-service	6
Sequential Initial Timing		Rest In Walk	No
Max Timer Starts For Call			
Reduction Starts For Call			
Red To Avoid Left Turn Trap			
Rest In Red	No		

Intersection 640 at Voyager Pkwy and Powers Blvd Northbound - Schedule table, events 1-25

Event Num	Enabled	Event Type	Event Parameters		Start					Duration Minutes	Stop		Repetition		Priority
			Param 1	Param 2	Mon	Day	Hour	Min	Sec		Mon	Day	Repeat	Intervals	
1	Yes	Run Plan	Plan 5	Ofst #1	1	1	06	30	00	720	12	31	Weekly	MTWTF	Medium
2															
3															
4															
5															
6															
7															
8															
9															
10															
11															
12															
13															
14															
15															
16															
17															
18															
19															
20															
21															
22															
23															
24															
25															

Intersection 640 at Voyager Pkwy and Powers Blvd Northbound - Coordination table, plans 5-6

Plan 5	111	Cycle Length	69	Phases	Splits	Alternate Mins	Alternate Passages	Alternate Maxes
	123456789012	Offset 1	49					
Coordinated Phases		Offset 2	0	1	0	0	0.0	0
	2 6	Offset 3	0	2	69	0	0.0	81
Secondary Coordinated Phases		Offset 4	0	3	0	0	0.0	0
		Relative Secondary Offset	0	4	0	0	0.0	0
Extra Time Phases		Permissive Period	Auto	5	32	0	0.0	36
		Max Cycle Addition	17	6	37	0	0.0	41
Additional Max Recalls		Max Cycle Subtraction	17	7	0	0	0.0	0
		Coord Actuated Period	0	8	0	0	0.0	0
Units	Seconds	Top Of Cycle Green Point	End	9	0	0	0.0	0
		Big Bang Preempt Recvry	No	10	0	0	0.0	0
		Big Bang Ped Recovery	No	11	0	0	0.0	0
		Min Lagging Left Split	0%	12	0	0	0.0	0
Plan 6	111	Cycle Length	0	Phases	Splits	Alternate Mins	Alternate Passages	Alternate Maxes
	123456789012	Offset 1	0					
Coordinated Phases		Offset 2	0	1	0	0	0.0	0
		Offset 3	0	2	0	0	0.0	0
Secondary Coordinated Phases		Offset 4	0	3	0	0	0.0	0
		Relative Secondary Offset	0	4	0	0	0.0	0
Extra Time Phases		Permissive Period	Auto	5	0	0	0.0	0
		Max Cycle Addition	0	6	0	0	0.0	0
Additional Max Recalls		Max Cycle Subtraction	0	7	0	0	0.0	0
		Coord Actuated Period	0	8	0	0	0.0	0
Units	Seconds	Top Of Cycle Green Point	End	9	0	0	0.0	0
		Big Bang Preempt Recvry	No	10	0	0	0.0	0
		Big Bang Ped Recovery	No	11	0	0	0.0	0
		Min Lagging Left Split	0%	12	0	0	0.0	0

Intersection 639 at Voyager Pkwy and Powers Blvd Southbound - Timing table, page 1

Page 1	Phases											
	1	2	3	4	5	6	7	8	9	10	11	12
Min Green	0	4	0	4	0	4	0	0	0	0	0	0
Passage Time I	0.0	2.0	0.0	2.0	0.0	2.0	0.0	0.0	0.0	0.0	0.0	0.0
Passage Time II	0.0	2.0	0.0	2.0	0.0	2.0	0.0	0.0	0.0	0.0	0.0	0.0
Max Green I	0	30	0	30	0	30	0	0	0	0	0	0
Max Green II	0	30	0	30	0	30	0	0	0	0	0	0
Yellow Clearance	0.0	4.0	0.0	4.0	0.0	4.0	0.0	0.0	0.0	0.0	0.0	0.0
Red Clearance	0.0	2.0	0.0	2.0	0.0	2.0	0.0	0.0	0.0	0.0	0.0	0.0
Added Initial	0.0	0.0	0.0	0.0	0.0	0.0	0.0	0.0	0.0	0.0	0.0	0.0
Max Added Initial	0	0	0	0	0	0	0	0	0	0	0	0
Time Before Reduction	0	0	0	0	0	0	0	0	0	0	0	0
Cars Before Reduction	0	0	0	0	0	0	0	0	0	0	0	0
Time To Reduce	0	0	0	0	0	0	0	0	0	0	0	0
Min Passage	0.0	0.0	0.0	0.0	0.0	0.0	0.0	0.0	0.0	0.0	0.0	0.0
Recall Green Time	0	0	0	0	0	0	0	0	0	0	0	0
Red Revert Time	0.0	5.0	0.0	5.0	0.0	5.0	0.0	0.0	0.0	0.0	0.0	0.0
Walk Time	0	0	0	0	0	7	0	0	0	0	0	0
Pedestrian Clearance	0	0	0	0	0	20	0	0	0	0	0	0
Handicap Walk	0	0	0	0	0	0	0	0	0	0	0	0
Handicap Ped Clearance	0	0	0	0	0	0	0	0	0	0	0	0
Voyager Pkwy		X				X						
Powers Blvd Southbound				X								
Compass Direction		N		E		S						
Through, Turn or XPed		Thru		Thru		Thru						

Intersection 639 at Voyager Pkwy and Powers Blvd Southbound - Sequence table, page 1

Page 1	Ring 1 Phases				Ring 2 Phases				Ring 3 Phases			
	1	2	3	4	5	6	7	8	9	10	11	12
State 1		Vehicle				V & P						
Barrier 1	XXXXXXXXXXXXXXXXXXXXXXXXXXXX				XXXXXXXXXXXXXXXXXXXXXXXXXXXX							
State 2			Vehicle									
Barrier 2	XXXXXXXXXXXXXXXXXXXXXXXXXXXX				XXXXXXXXXXXXXXXXXXXXXXXXXXXX							
State 3												
Barrier 3												
State 4												
Barrier 4												
State 5												
Barrier 5												
State 6												
Barrier 6												
State 7												
Barrier 7												
State 8												
Barrier 8												
State 9												
Barrier 9												
State 10												
Barrier 10												
State 11												
Barrier 11												
State 12												
Barrier 12												

Intersection 639 at Voyager Pkwy and Powers Blvd Southbound - Phases control table, page 1

Page 1	Vehicle Phases		Ped Phases
	111 123456789012		111 123456789012
Min Recalls		Ped Recalls	
Max Recalls	2 6	Handicap Ped Recalls	
Recall If Maxed		Soft Ped Recalls	
Dual Entry		Do Not Recall Ped	2 4 6 8
Do Not Skip		Allow Walk Reduction	
Simultaneous Gap Out		Hold In Walk	
Restricted Phases		Allow Ped Re-service	6
Sequential Initial Timing		Rest In Walk	No
Max Timer Starts For Call			
Reduction Starts For Call			
Red To Avoid Left Turn Trap			
Rest In Red	No		

Intersection 639 at Voyager Pkwy and Powers Blvd Southbound - Schedule table, events 1-25

Event Num	Enabled	Event Type	Event Parameters		Start					Duration Minutes	Stop		Repetition		Priority
			Param 1	Param 2	Mon	Day	Hour	Min	Sec		Mon	Day	Repeat	Intervals	
1	Yes	Run Plan	Plan 5	Ofst #1	1	1	06	30	00	720	12	31	Weekly	MTWTF	Medium
2															
3															
4															
5															
6															
7															
8															
9															
10															
11															
12															
13															
14															
15															
16															
17															
18															
19															
20															
21															
22															
23															
24															
25															

Intersection 639 at Voyager Pkwy and Powers Blvd Southbound - Coordination table, plans 5-6

Plan 5	111	Cycle Length	69	Phases	Splits	Alternate Mins	Alternate Passages	Alternate Maxes
	123456789012	Offset 1	49					
Coordinated Phases		Offset 2	0	1	0	0	0.0	0
	2 6	Offset 3	0	2	38	0	0.0	42
Secondary Coordinated Phases		Offset 4	0	3	0	0	0.0	0
		Relative Secondary Offset	0	4	31	0	0.0	33
Extra Time Phases		Permissive Period	Auto	5	0	0	0.0	0
		Max Cycle Addition	17	6	38	0	0.0	42
Additional Max Recalls		Max Cycle Subtraction	17	7	0	0	0.0	0
		Coord Actuated Period	0	8	0	0	0.0	0
Units	Seconds	Top Of Cycle Green Point	End	9	0	0	0.0	0
		Big Bang Preempt Recvry	No	10	0	0	0.0	0
		Big Bang Ped Recovery	No	11	0	0	0.0	0
		Min Lagging Left Split	0%	12	0	0	0.0	0
Plan 6	111	Cycle Length	0	Phases	Splits	Alternate Mins	Alternate Passages	Alternate Maxes
	123456789012	Offset 1	0					
Coordinated Phases		Offset 2	0	1	0	0	0.0	0
		Offset 3	0	2	0	0	0.0	0
Secondary Coordinated Phases		Offset 4	0	3	0	0	0.0	0
		Relative Secondary Offset	0	4	0	0	0.0	0
Extra Time Phases		Permissive Period	Auto	5	0	0	0.0	0
		Max Cycle Addition	0	6	0	0	0.0	0
Additional Max Recalls		Max Cycle Subtraction	0	7	0	0	0.0	0
		Coord Actuated Period	0	8	0	0	0.0	0
Units	Seconds	Top Of Cycle Green Point	End	9	0	0	0.0	0
		Big Bang Preempt Recvry	No	10	0	0	0.0	0
		Big Bang Ped Recovery	No	11	0	0	0.0	0
		Min Lagging Left Split	0%	12	0	0	0.0	0

Intersection 641 at Voyager Pkwy and Spectrum Loop South - Timing table, page 1

Page 1	Phases											
	1	2	3	4	5	6	7	8	9	10	11	12
Min Green	4	4	0	4	4	4	0	4	0	0	0	0
Passage Time I	2.0	2.0	0.0	2.0	2.0	2.0	0.0	2.0	0.0	0.0	0.0	0.0
Passage Time II	2.0	2.0	0.0	2.0	2.0	2.0	0.0	2.0	0.0	0.0	0.0	0.0
Max Green I	15	40	0	30	15	40	0	30	0	0	0	0
Max Green II	15	40	0	30	15	40	0	30	0	0	0	0
Yellow Clearance	3.0	4.5	0.0	4.5	3.0	4.5	0.0	4.5	0.0	0.0	0.0	0.0
Red Clearance	2.0	2.0	0.0	2.0	2.0	2.0	0.0	2.0	0.0	0.0	0.0	0.0
Added Initial	0.0	0.0	0.0	0.0	0.0	0.0	0.0	0.0	0.0	0.0	0.0	0.0
Max Added Initial	0	0	0	0	0	0	0	0	0	0	0	0
Time Before Reduction	0	0	0	0	0	0	0	0	0	0	0	0
Cars Before Reduction	0	0	0	0	0	0	0	0	0	0	0	0
Time To Reduce	0	0	0	0	0	0	0	0	0	0	0	0
Min Passage	0.0	0.0	0.0	0.0	0.0	0.0	0.0	0.0	0.0	0.0	0.0	0.0
Recall Green Time	0	0	0	0	0	0	0	0	0	0	0	0
Red Revert Time	5.0	5.0	0.0	5.0	5.0	5.0	0.0	5.0	0.0	0.0	0.0	0.0
Walk Time	0	7	0	0	0	7	0	7	0	0	0	0
Pedestrian Clearance	0	24	0	0	0	24	0	36	0	0	0	0
Handicap Walk	0	12	0	0	0	12	0	12	0	0	0	0
Handicap Ped Clearance	0	28	0	0	0	28	0	41	0	0	0	0
Voyager Pkwy	X	X			X	X						
Spectrum Loop South				X				X				
Compass Direction	S	N		E	N	S		W				
Through, Turn or XPed	Left,prt	Thru		Thru	Left,prt	Thru		Thru				

Intersection 641 at Voyager Pkwy and Spectrum Loop South - Sequence table, page 1

Page 1	Ring 1 Phases				Ring 2 Phases				Ring 3 Phases			
	1	2	3	4	5	6	7	8	9	10	11	12
State 1	Vehicle				Vehicle							
Barrier 1												
State 2		V & P				V & P						
Barrier 2	XXXXXXXXXXXXXXXXXXXXXXXXXX				XXXXXXXXXXXXXXXXXXXXXXXXXX							
State 3				Vehicle				V & P				
Barrier 3	XXXXXXXXXXXXXXXXXXXXXXXXXX				XXXXXXXXXXXXXXXXXXXXXXXXXX							
State 4												
Barrier 4												
State 5												
Barrier 5												
State 6												
Barrier 6												
State 7												
Barrier 7												
State 8												
Barrier 8												
State 9												
Barrier 9												
State 10												
Barrier 10												
State 11												
Barrier 11												
State 12												
Barrier 12												

Intersection 641 at Voyager Pkwy and Spectrum Loop South - Phases control table, page 1

Page 1	Vehicle Phases		Ped Phases
	111 123456789012		111 123456789012
Min Recalls		Ped Recalls	
Max Recalls	2 6	Handicap Ped Recalls	
Recall If Maxed		Soft Ped Recalls	
Dual Entry	4 8	Do Not Recall Ped	2 4 6 8
Do Not Skip		Allow Walk Reduction	
Simultaneous Gap Out		Hold In Walk	
Restricted Phases		Allow Ped Re-service	
Sequential Initial Timing		Rest In Walk	No
Max Timer Starts For Call			
Reduction Starts For Call			
Red To Avoid Left Turn Trap			
Rest In Red	No		

Intersection 641 at Voyager Pkwy and Spectrum Loop South - Schedule table, events 1-25

Event Num	Enabled	Event Type	Event Parameters		Start					Duration Minutes	Stop		Repetition		Priority
			Param 1	Param 2	Mon	Day	Hour	Min	Sec		Mon	Day	Repeat	Intervals	
1	Yes	Run Plan	Plan 5	Ofst #1	1	1	06	30	00	720	12	31	Weekly	MTWTF	Low
2															
3															
4															
5															
6															
7															
8															
9															
10															
11															
12															
13															
14															
15															
16															
17															
18															
19															
20															
21															
22															
23															
24															
25															

Intersection 641 at Voyager Pkwy and Spectrum Loop South - Coordination table, plans 5-6

Plan 5	111	Cycle Length	138	Phases	Splits	Alternate Mins	Alternate Passages	Alternate Maxes
	123456789012	Offset 1	79					
Coordinated Phases	2 6	Offset 2	0	1	20	0	0.0	21
		Offset 3	0	2	82	0	0.0	96
Secondary Coordinated Phases		Offset 4	0	3	0	0	0.0	0
		Relative Secondary Offset	0	4	36	0	0.0	39
Extra Time Phases		Permissive Period	Auto	5	20	0	0.0	21
		Max Cycle Addition	34	6	82	0	0.0	96
Additional Max Recalls		Max Cycle Subtraction	34	7	0	0	0.0	0
		Coord Actuated Period	0	8	36	0	0.0	39
Units	Seconds	Top Of Cycle Green Point	End	9	0	0	0.0	0
		Big Bang Preempt Recvry	No	10	0	0	0.0	0
		Big Bang Ped Recovery	No	11	0	0	0.0	0
		Min Lagging Left Split	0%	12	0	0	0.0	0
Plan 6	111	Cycle Length	0	Phases	Splits	Alternate Mins	Alternate Passages	Alternate Maxes
	123456789012	Offset 1	0					
Coordinated Phases		Offset 2	0	1	0	0	0.0	0
		Offset 3	0	2	0	0	0.0	0
Secondary Coordinated Phases		Offset 4	0	3	0	0	0.0	0
		Relative Secondary Offset	0	4	0	0	0.0	0
Extra Time Phases		Permissive Period	Auto	5	0	0	0.0	0
		Max Cycle Addition	0	6	0	0	0.0	0
Additional Max Recalls		Max Cycle Subtraction	0	7	0	0	0.0	0
		Coord Actuated Period	0	8	0	0	0.0	0
Units	Seconds	Top Of Cycle Green Point	End	9	0	0	0.0	0
		Big Bang Preempt Recvry	No	10	0	0	0.0	0
		Big Bang Ped Recovery	No	11	0	0	0.0	0
		Min Lagging Left Split	0%	12	0	0	0.0	0

APPENDIX F

Queues Analysis Worksheets

Queues

2024 Total AM

1: Voyager Pkwy & North Gate Blvd

08/29/2022

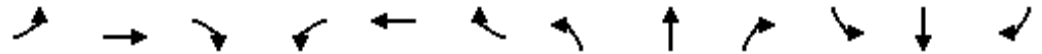

Lane Group	EBL	EBT	EBR	WBL	WBT	WBR	NBL	NBT	NBR	SBL	SBT	SBR
Lane Group Flow (vph)	9	370	218	388	488	15	239	27	242	58	86	44
v/c Ratio	0.02	0.22	0.25	0.53	0.21	0.01	0.61	0.11	0.58	0.23	0.51	0.13
Control Delay	11.4	22.5	4.5	12.6	11.4	0.0	57.3	44.6	11.5	34.6	61.9	0.8
Queue Delay	0.0	0.0	0.0	0.0	0.0	0.0	0.0	0.0	0.0	0.0	0.0	0.0
Total Delay	11.4	22.5	4.5	12.6	11.4	0.0	57.3	44.6	11.5	34.6	61.9	0.8
Queue Length 50th (ft)	2	90	0	123	77	0	92	19	0	34	65	0
Queue Length 95th (ft)	10	158	56	215	155	0	130	45	71	63	115	0
Internal Link Dist (ft)		719			867			796			210	
Turn Bay Length (ft)	275			400		250	275			100		100
Base Capacity (vph)	580	1677	864	760	2270	1077	572	419	543	305	294	434
Starvation Cap Reductn	0	0	0	0	0	0	0	0	0	0	0	0
Spillback Cap Reductn	0	0	0	0	0	0	0	0	0	0	0	0
Storage Cap Reductn	0	0	0	0	0	0	0	0	0	0	0	0
Reduced v/c Ratio	0.02	0.22	0.25	0.51	0.21	0.01	0.42	0.06	0.45	0.19	0.29	0.10

Intersection Summary

Queues

2024 Total PM

1: Voyager Pkwy & North Gate Blvd

08/29/2022



Lane Group	EBL	EBT	EBR	WBL	WBT	WBR	NBL	NBT	NBR	SBL	SBT	SBR
Lane Group Flow (vph)	30	499	278	367	457	32	324	58	292	34	41	25
v/c Ratio	0.06	0.29	0.31	0.57	0.22	0.03	0.69	0.20	0.59	0.17	0.33	0.08
Control Delay	10.5	22.4	4.1	13.2	13.7	0.1	57.3	44.5	10.1	34.0	59.5	0.5
Queue Delay	0.0	0.0	0.0	0.0	0.0	0.0	0.0	0.0	0.0	0.0	0.0	0.0
Total Delay	10.5	22.4	4.1	13.2	13.7	0.1	57.3	44.5	10.1	34.0	59.5	0.5
Queue Length 50th (ft)	8	124	0	114	93	0	124	40	0	20	31	0
Queue Length 95th (ft)	22	205	58	195	144	0	168	78	77	43	67	0
Internal Link Dist (ft)		719			867			796			210	
Turn Bay Length (ft)	275			400		250	275			100		100
Base Capacity (vph)	599	1696	903	680	2123	1018	572	419	582	272	294	434
Starvation Cap Reductn	0	0	0	0	0	0	0	0	0	0	0	0
Spillback Cap Reductn	0	0	0	0	0	0	0	0	0	0	0	0
Storage Cap Reductn	0	0	0	0	0	0	0	0	0	0	0	0
Reduced v/c Ratio	0.05	0.29	0.31	0.54	0.22	0.03	0.57	0.14	0.50	0.13	0.14	0.06

Intersection Summary

Queues

2045 Total AM

1: Voyager Pkwy & North Gate Blvd

08/29/2022

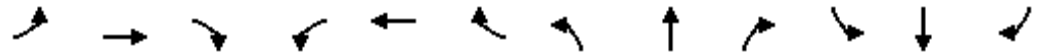

Lane Group	EBL	EBT	EBR	WBL	WBT	WBR	NBL	NBT	NBR	SBL	SBT	SBR
Lane Group Flow (vph)	9	647	375	691	881	15	378	27	411	58	86	44
v/c Ratio	0.03	0.52	0.47	0.83	0.41	0.01	0.79	0.08	0.65	0.31	0.51	0.13
Control Delay	14.5	35.8	5.8	52.5	14.6	0.0	62.1	37.4	8.9	37.3	61.9	0.8
Queue Delay	0.0	0.0	0.0	0.0	0.0	0.0	0.0	0.0	0.0	0.0	0.0	0.0
Total Delay	14.5	35.8	5.8	52.5	14.6	0.0	62.1	37.4	8.9	37.3	61.9	0.8
Queue Length 50th (ft)	3	220	0	262	179	0	145	17	0	33	65	0
Queue Length 95th (ft)	10	314	80	315	305	0	200	41	85	63	115	0
Internal Link Dist (ft)		719			867			796			210	
Turn Bay Length (ft)	275			400		250	275			100		100
Base Capacity (vph)	306	1239	798	911	2175	1039	514	496	723	187	279	422
Starvation Cap Reductn	0	0	0	0	0	0	0	0	0	0	0	0
Spillback Cap Reductn	0	0	0	0	0	0	0	0	0	0	0	0
Storage Cap Reductn	0	0	0	0	0	0	0	0	0	0	0	0
Reduced v/c Ratio	0.03	0.52	0.47	0.76	0.41	0.01	0.74	0.05	0.57	0.31	0.31	0.10

Intersection Summary

Queues

2045 Total PM

1: Voyager Pkwy & North Gate Blvd

08/29/2022



Lane Group	EBL	EBT	EBR	WBL	WBT	WBR	NBL	NBT	NBR	SBL	SBT	SBR
Lane Group Flow (vph)	30	892	449	639	802	32	550	58	510	34	41	25
v/c Ratio	0.10	0.82	0.60	0.78	0.43	0.03	0.78	0.14	0.67	0.17	0.33	0.08
Control Delay	17.2	47.6	12.3	50.0	21.2	0.1	52.8	35.8	8.0	29.3	59.5	0.5
Queue Delay	0.0	0.0	0.0	0.0	0.0	0.0	0.0	0.0	0.0	0.0	0.0	0.0
Total Delay	17.2	47.6	12.3	50.0	21.2	0.1	52.8	35.8	8.0	29.3	59.5	0.5
Queue Length 50th (ft)	9	346	45	239	215	0	209	37	0	18	31	0
Queue Length 95th (ft)	27	#623	183	292	321	0	254	68	89	37	67	0
Internal Link Dist (ft)		719			867			796			210	
Turn Bay Length (ft)	275			400		250	275			100		100
Base Capacity (vph)	307	1094	746	821	1871	918	1029	543	822	376	279	422
Starvation Cap Reductn	0	0	0	0	0	0	0	0	0	0	0	0
Spillback Cap Reductn	0	0	0	0	0	0	0	0	0	0	0	0
Storage Cap Reductn	0	0	0	0	0	0	0	0	0	0	0	0
Reduced v/c Ratio	0.10	0.82	0.60	0.78	0.43	0.03	0.53	0.11	0.62	0.09	0.15	0.06

Intersection Summary

95th percentile volume exceeds capacity, queue may be longer.

Queue shown is maximum after two cycles.

Queues
3: Voyager Pkwy & Spectrum Loop

2024 Total AM - Improved

08/29/2022

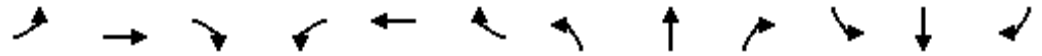

Lane Group	EBL	EBT	EBR	WBL	WBT	WBR	NBL	NBT	NBR	SBL	SBT	SBR
Lane Group Flow (vph)	67	7	79	143	11	78	83	380	74	24	630	57
v/c Ratio	0.34	0.03	0.27	0.72	0.04	0.27	0.14	0.15	0.06	0.03	0.26	0.05
Control Delay	56.2	47.2	12.0	76.0	47.8	12.1	12.1	16.2	11.8	4.9	9.9	1.9
Queue Delay	0.0	0.0	0.0	0.0	0.0	0.0	0.0	0.0	0.0	0.0	0.0	0.0
Total Delay	56.2	47.2	12.0	76.0	47.8	12.1	12.1	16.2	11.8	4.9	9.9	1.9
Queue Length 50th (ft)	55	5	0	124	9	0	29	91	2	4	107	0
Queue Length 95th (ft)	97	19	45	189	26	45	86	168	61	14	170	14
Internal Link Dist (ft)		368			239			659			796	
Turn Bay Length (ft)	200			100		225	525		250	200		
Base Capacity (vph)	440	587	553	442	587	552	652	2531	1153	776	2393	1092
Starvation Cap Reductn	0	0	0	0	0	0	0	0	0	0	0	0
Spillback Cap Reductn	0	0	0	0	0	0	0	0	0	0	0	0
Storage Cap Reductn	0	0	0	0	0	0	0	0	0	0	0	0
Reduced v/c Ratio	0.15	0.01	0.14	0.32	0.02	0.14	0.13	0.15	0.06	0.03	0.26	0.05

Intersection Summary

Queues
3: Voyager Pkwy & Spectrum Loop

2024 Total PM - Improved

08/29/2022

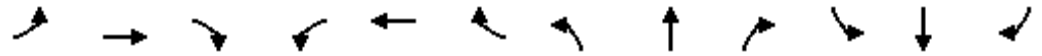

Lane Group	EBL	EBT	EBR	WBL	WBT	WBR	NBL	NBT	NBR	SBL	SBT	SBR
Lane Group Flow (vph)	116	39	200	210	34	110	234	433	256	96	400	110
v/c Ratio	0.41	0.10	0.41	0.74	0.09	0.27	0.32	0.20	0.24	0.15	0.20	0.12
Control Delay	49.7	41.0	7.6	66.3	40.7	8.2	9.2	14.0	2.6	8.7	17.2	3.8
Queue Delay	0.0	0.0	0.0	0.0	0.0	0.0	0.0	0.0	0.0	0.0	0.0	0.0
Total Delay	49.7	41.0	7.6	66.3	40.7	8.2	9.2	14.0	2.6	8.7	17.2	3.8
Queue Length 50th (ft)	91	29	0	179	25	0	64	86	0	24	90	0
Queue Length 95th (ft)	134	54	56	239	49	44	125	145	41	55	151	33
Internal Link Dist (ft)		368			239			659			796	
Turn Bay Length (ft)	200			100		225	525		250	200		
Base Capacity (vph)	848	1154	1056	845	1154	1022	721	2140	1058	669	1971	930
Starvation Cap Reductn	0	0	0	0	0	0	0	0	0	0	0	0
Spillback Cap Reductn	0	0	0	0	0	0	0	0	0	0	0	0
Storage Cap Reductn	0	0	0	0	0	0	0	0	0	0	0	0
Reduced v/c Ratio	0.14	0.03	0.19	0.25	0.03	0.11	0.32	0.20	0.24	0.14	0.20	0.12

Intersection Summary

Queues
3: Voyager Pkwy & Spectrum Loop

2045 Total AM
08/29/2022



Lane Group	EBL	EBT	EBR	WBL	WBT	WBR	NBL	NBT	NBR	SBL	SBT	SBR
Lane Group Flow (vph)	82	8	137	153	12	78	149	674	79	25	1124	86
v/c Ratio	0.39	0.03	0.39	0.74	0.04	0.26	0.41	0.27	0.07	0.04	0.48	0.08
Control Delay	56.9	46.3	10.5	75.4	46.9	11.7	15.5	18.9	11.0	5.3	13.7	3.2
Queue Delay	0.0	0.0	0.0	0.0	0.0	0.0	0.0	0.0	0.0	0.0	0.0	0.0
Total Delay	56.9	46.3	10.5	75.4	46.9	11.7	15.5	18.9	11.0	5.3	13.7	3.2
Queue Length 50th (ft)	67	6	0	133	9	0	89	234	27	5	246	3
Queue Length 95th (ft)	113	21	57	199	27	44	123	244	52	15	374	27
Internal Link Dist (ft)		368			239			659			796	
Turn Bay Length (ft)	200			100		225	525		250	200		
Base Capacity (vph)	440	587	592	441	587	552	413	2503	1143	594	2327	1067
Starvation Cap Reductn	0	0	0	0	0	0	0	0	0	0	0	0
Spillback Cap Reductn	0	0	0	0	0	0	0	0	0	0	0	0
Storage Cap Reductn	0	0	0	0	0	0	0	0	0	0	0	0
Reduced v/c Ratio	0.19	0.01	0.23	0.35	0.02	0.14	0.36	0.27	0.07	0.04	0.48	0.08

Intersection Summary

Queues
3: Voyager Pkwy & Spectrum Loop

2045 Total PM
08/29/2022



Lane Group	EBL	EBT	EBR	WBL	WBT	WBR	NBL	NBT	NBR	SBL	SBT	SBR
Lane Group Flow (vph)	174	42	349	223	37	113	415	761	272	97	701	154
v/c Ratio	0.58	0.10	0.56	0.75	0.09	0.26	0.58	0.37	0.27	0.28	0.60	0.25
Control Delay	54.8	39.8	7.4	65.1	39.5	7.8	17.8	17.5	4.3	15.3	40.1	6.4
Queue Delay	0.0	0.0	0.0	0.0	0.0	0.0	0.0	0.0	0.0	0.0	0.0	0.0
Total Delay	54.8	39.8	7.4	65.1	39.5	7.8	17.8	17.5	4.3	15.3	40.1	6.4
Queue Length 50th (ft)	142	31	0	189	27	0	142	176	13	25	246	5
Queue Length 95th (ft)	197	56	72	253	51	45	315	296	68	60	334	55
Internal Link Dist (ft)		368			239			659			796	
Turn Bay Length (ft)	200			100		225	525		250	200		
Base Capacity (vph)	845	1154	1113	842	1154	1023	716	2073	1024	378	1174	621
Starvation Cap Reductn	0	0	0	0	0	0	0	0	0	0	0	0
Spillback Cap Reductn	0	0	0	0	0	0	0	0	0	0	0	0
Storage Cap Reductn	0	0	0	0	0	0	0	0	0	0	0	0
Reduced v/c Ratio	0.21	0.04	0.31	0.26	0.03	0.11	0.58	0.37	0.27	0.26	0.60	0.25

Intersection Summary

5: Voyager Pkwy & Powers Blvd On-Ramp

09/06/2022



Lane Group	NBL	NBT	SBT	SBR
Lane Group Flow (vph)	372	602	675	253
v/c Ratio	0.74	0.17	0.34	0.16
Control Delay	36.6	0.1	13.3	0.2
Queue Delay	0.2	0.0	0.0	0.0
Total Delay	36.8	0.1	13.3	0.2
Queue Length 50th (ft)	156	0	157	0
Queue Length 95th (ft)	294	0	208	0
Internal Link Dist (ft)		270	659	
Turn Bay Length (ft)	250			250
Base Capacity (vph)	692	3539	1963	1583
Starvation Cap Reductn	40	0	0	0
Spillback Cap Reductn	0	0	0	0
Storage Cap Reductn	0	0	0	0
Reduced v/c Ratio	0.57	0.17	0.34	0.16

Intersection Summary

5: Voyager Pkwy & Powers Blvd On-Ramp

09/06/2022



Lane Group	NBL	NBT	SBT	SBR
Lane Group Flow (vph)	311	848	589	221
v/c Ratio	0.70	0.24	0.28	0.14
Control Delay	32.5	0.2	8.6	0.2
Queue Delay	0.0	0.0	0.0	0.0
Total Delay	32.6	0.2	8.6	0.2
Queue Length 50th (ft)	118	0	98	0
Queue Length 95th (ft)	231	0	128	0
Internal Link Dist (ft)		270	659	
Turn Bay Length (ft)	250			250
Base Capacity (vph)	692	3539	2079	1583
Starvation Cap Reductn	17	0	0	0
Spillback Cap Reductn	0	0	0	0
Storage Cap Reductn	0	0	0	0
Reduced v/c Ratio	0.46	0.24	0.28	0.14

Intersection Summary

5: Voyager Pkwy & Powers Blvd On-Ramp

09/07/2022



Lane Group	NBL	NBT	SBT	SBR
Lane Group Flow (vph)	676	1087	1220	443
v/c Ratio	0.85	0.31	0.62	0.28
Control Delay	43.8	0.2	36.0	0.4
Queue Delay	6.2	0.0	2.0	0.0
Total Delay	50.0	0.2	38.0	0.4
Queue Length 50th (ft)	329	0	515	0
Queue Length 95th (ft)	366	0	662	0
Internal Link Dist (ft)		270	659	
Turn Bay Length (ft)	250			250
Base Capacity (vph)	938	3539	1976	1583
Starvation Cap Reductn	209	0	426	0
Spillback Cap Reductn	0	0	570	0
Storage Cap Reductn	0	0	0	0
Reduced v/c Ratio	0.93	0.31	0.87	0.28

Intersection Summary

5: Voyager Pkwy & Powers Blvd On-Ramp

09/07/2022



Lane Group	NBL	NBT	SBT	SBR
Lane Group Flow (vph)	562	1524	1065	389
v/c Ratio	0.76	0.43	0.46	0.25
Control Delay	34.8	0.6	23.1	0.3
Queue Delay	0.8	0.0	0.1	0.0
Total Delay	35.6	0.6	23.2	0.3
Queue Length 50th (ft)	237	14	407	0
Queue Length 95th (ft)	354	0	557	0
Internal Link Dist (ft)		270	659	
Turn Bay Length (ft)	250			250
Base Capacity (vph)	1047	3539	2318	1583
Starvation Cap Reductn	217	0	0	0
Spillback Cap Reductn	0	0	265	0
Storage Cap Reductn	0	0	0	0
Reduced v/c Ratio	0.68	0.43	0.52	0.25
Intersection Summary				

6: Voyager Pkwy & Powers Blvd Off-Ramp

09/06/2022



Lane Group	EBL	EBR	NBT	SBT
Lane Group Flow (vph)	133	509	848	683
v/c Ratio	0.38	0.32	0.22	0.25
Control Delay	31.5	0.5	4.9	1.3
Queue Delay	0.0	0.0	0.0	0.0
Total Delay	31.5	0.5	4.9	1.3
Queue Length 50th (ft)	27	0	33	15
Queue Length 95th (ft)	50	0	145	17
Internal Link Dist (ft)	435		782	270
Turn Bay Length (ft)	325			
Base Capacity (vph)	1243	1583	3928	2733
Starvation Cap Reductn	0	0	0	0
Spillback Cap Reductn	46	0	47	0
Storage Cap Reductn	0	0	0	0
Reduced v/c Ratio	0.11	0.32	0.22	0.25

Intersection Summary

6: Voyager Pkwy & Powers Blvd Off-Ramp

09/06/2022



Lane Group	EBL	EBR	NBT	SBT
Lane Group Flow (vph)	324	367	834	552
v/c Ratio	0.60	0.23	0.25	0.23
Control Delay	31.3	0.3	7.7	1.2
Queue Delay	0.0	0.0	0.0	0.0
Total Delay	31.3	0.3	7.7	1.2
Queue Length 50th (ft)	67	0	63	10
Queue Length 95th (ft)	97	0	170	11
Internal Link Dist (ft)	435		782	270
Turn Bay Length (ft)	325			
Base Capacity (vph)	1243	1583	3394	2362
Starvation Cap Reductn	0	0	0	0
Spillback Cap Reductn	23	0	0	0
Storage Cap Reductn	0	0	0	0
Reduced v/c Ratio	0.27	0.23	0.25	0.23

Intersection Summary

Queues

2045 Total AM

6: Voyager Pkwy & Powers Blvd Off-Ramp

09/06/2022



Lane Group	EBL	EBR	NBT	SBT
Lane Group Flow (vph)	237	925	1539	1235
v/c Ratio	0.52	0.58	0.44	0.50
Control Delay	31.6	1.6	9.5	4.3
Queue Delay	0.1	0.1	0.1	0.0
Total Delay	31.7	1.6	9.7	4.3
Queue Length 50th (ft)	48	0	266	75
Queue Length 95th (ft)	77	0	300	81
Internal Link Dist (ft)	435		782	270
Turn Bay Length (ft)	325			
Base Capacity (vph)	1243	1583	3524	2452
Starvation Cap Reductn	0	0	0	129
Spillback Cap Reductn	272	55	727	0
Storage Cap Reductn	0	0	0	0
Reduced v/c Ratio	0.24	0.61	0.55	0.53

Intersection Summary

6: Voyager Pkwy & Powers Blvd Off-Ramp

09/06/2022



Lane Group	EBL	EBR	NBT	SBT
Lane Group Flow (vph)	574	669	1511	996
v/c Ratio	0.72	0.42	0.50	0.47
Control Delay	29.6	0.8	13.0	5.9
Queue Delay	0.2	0.0	0.1	0.0
Total Delay	29.9	0.8	13.1	5.9
Queue Length 50th (ft)	115	0	318	71
Queue Length 95th (ft)	152	0	264	75
Internal Link Dist (ft)	435		782	270
Turn Bay Length (ft)	325			
Base Capacity (vph)	1243	1583	3021	2102
Starvation Cap Reductn	0	0	0	62
Spillback Cap Reductn	187	0	396	0
Storage Cap Reductn	0	0	0	0
Reduced v/c Ratio	0.54	0.42	0.58	0.49

Intersection Summary

Queues

2024 Total AM

7: Voyager Pkwy & S. Spectrum Loop

09/06/2022



Lane Group	EBL	EBT	EBR	WBL	WBT	WBR	NBL	NBT	NBR	SBL	SBT	SBR
Lane Group Flow (vph)	11	8	39	32	3	54	25	775	67	62	1098	41
v/c Ratio	0.14	0.08	0.26	0.42	0.03	0.36	0.30	0.28	0.05	0.53	0.38	0.03
Control Delay	64.4	61.6	8.0	77.7	60.0	15.8	72.0	5.9	1.5	72.8	5.1	1.4
Queue Delay	0.0	0.0	0.0	0.0	0.0	0.0	0.0	0.0	0.0	0.0	0.0	0.0
Total Delay	64.4	61.6	8.0	77.7	60.0	15.8	72.0	5.9	1.5	72.8	5.1	1.4
Queue Length 50th (ft)	10	7	0	28	3	0	22	104	0	54	115	0
Queue Length 95th (ft)	30	25	13	64	14	32	53	162	14	m89	241	m4
Internal Link Dist (ft)		411			346			397			782	
Turn Bay Length (ft)			350	150		125	450		200	400		
Base Capacity (vph)	300	398	391	299	398	391	192	2786	1260	192	2905	1311
Starvation Cap Reductn	0	0	0	0	0	0	0	0	0	0	0	0
Spillback Cap Reductn	0	0	0	0	0	0	0	0	0	0	0	0
Storage Cap Reductn	0	0	0	0	0	0	0	0	0	0	0	0
Reduced v/c Ratio	0.04	0.02	0.10	0.11	0.01	0.14	0.13	0.28	0.05	0.32	0.38	0.03

Intersection Summary

m Volume for 95th percentile queue is metered by upstream signal.

Queues

2024 Total PM

7: Voyager Pkwy & S. Spectrum Loop

09/06/2022



Lane Group	EBL	EBT	EBR	WBL	WBT	WBR	NBL	NBT	NBR	SBL	SBT	SBR
Lane Group Flow (vph)	48	4	78	59	4	91	89	851	72	52	855	37
v/c Ratio	0.47	0.03	0.41	0.57	0.03	0.45	0.62	0.32	0.06	0.48	0.34	0.03
Control Delay	74.4	56.8	18.6	81.8	56.8	18.3	78.7	7.1	1.7	77.8	5.6	0.2
Queue Delay	0.0	0.0	0.0	0.0	0.0	0.0	0.0	0.0	0.0	0.0	0.0	0.0
Total Delay	74.4	56.8	18.6	81.8	56.8	18.3	78.7	7.1	1.7	77.8	5.6	0.2
Queue Length 50th (ft)	42	3	0	52	3	0	79	125	0	45	95	0
Queue Length 95th (ft)	83	16	50	99	16	53	133	195	16	93	126	m1
Internal Link Dist (ft)		411			346			397			782	
Turn Bay Length (ft)			350	150		125	450		200	400		
Base Capacity (vph)	300	398	399	300	398	409	195	2649	1203	192	2526	1149
Starvation Cap Reductn	0	0	0	0	0	0	0	0	0	0	0	0
Spillback Cap Reductn	0	0	0	0	0	0	0	0	0	0	0	0
Storage Cap Reductn	0	0	0	0	0	0	0	0	0	0	0	0
Reduced v/c Ratio	0.16	0.01	0.20	0.20	0.01	0.22	0.46	0.32	0.06	0.27	0.34	0.03

Intersection Summary

m Volume for 95th percentile queue is metered by upstream signal.

Queues

2045 Total AM

7: Voyager Pkwy & S. Spectrum Loop

09/06/2022



Lane Group	EBL	EBT	EBR	WBL	WBT	WBR	NBL	NBT	NBR	SBL	SBT	SBR
Lane Group Flow (vph)	16	15	43	57	7	99	36	1412	124	113	1992	73
v/c Ratio	0.16	0.11	0.24	0.56	0.05	0.48	0.39	0.57	0.11	0.67	0.74	0.06
Control Delay	61.3	59.4	8.2	81.7	57.7	18.5	74.3	12.3	3.3	76.2	16.2	3.2
Queue Delay	0.0	0.0	0.0	0.0	0.0	0.0	0.0	0.0	0.0	0.0	0.1	0.0
Total Delay	61.3	59.4	8.2	81.7	57.7	18.5	74.3	12.3	3.3	76.2	16.2	3.2
Queue Length 50th (ft)	14	13	0	50	6	0	32	302	9	105	552	6
Queue Length 95th (ft)	38	36	17	95	21	56	68	460	37	156	804	m11
Internal Link Dist (ft)		411			346			397			782	
Turn Bay Length (ft)			350	150		125	450		200	400		
Base Capacity (vph)	299	398	391	297	398	416	192	2482	1136	202	2681	1215
Starvation Cap Reductn	0	0	0	0	0	0	0	0	0	0	79	0
Spillback Cap Reductn	0	0	0	0	0	0	0	0	0	0	0	0
Storage Cap Reductn	0	0	0	0	0	0	0	0	0	0	0	0
Reduced v/c Ratio	0.05	0.04	0.11	0.19	0.02	0.24	0.19	0.57	0.11	0.56	0.77	0.06

Intersection Summary

m Volume for 95th percentile queue is metered by upstream signal.

Queues

2045 Total PM

7: Voyager Pkwy & S. Spectrum Loop

09/06/2022

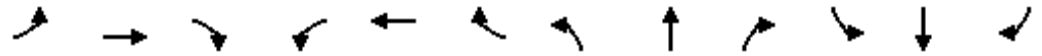

Lane Group	EBL	EBT	EBR	WBL	WBT	WBR	NBL	NBT	NBR	SBL	SBT	SBR
Lane Group Flow (vph)	80	9	124	107	9	165	133	1549	130	95	1553	62
v/c Ratio	0.53	0.04	0.44	0.71	0.04	0.52	0.70	0.65	0.12	0.63	0.67	0.06
Control Delay	69.5	52.1	13.6	82.7	52.1	13.5	77.6	15.8	4.4	76.4	23.4	5.1
Queue Delay	0.0	0.0	0.0	0.0	0.0	0.0	0.0	0.0	0.0	0.0	0.0	0.0
Total Delay	69.5	52.1	13.6	82.7	52.1	13.5	77.6	15.8	4.4	76.4	23.4	5.1
Queue Length 50th (ft)	69	7	0	94	7	0	117	390	13	88	450	5
Queue Length 95th (ft)	119	24	58	153	24	65	182	596	45	140	646	11
Internal Link Dist (ft)		411			346			397			782	
Turn Bay Length (ft)			350	150		125	450		200	400		
Base Capacity (vph)	299	398	435	299	398	468	212	2392	1097	196	2311	1057
Starvation Cap Reductn	0	0	0	0	0	0	0	0	0	0	12	0
Spillback Cap Reductn	0	0	0	0	0	0	0	0	0	0	0	0
Storage Cap Reductn	0	0	0	0	0	0	0	0	0	0	0	0
Reduced v/c Ratio	0.27	0.02	0.29	0.36	0.02	0.35	0.63	0.65	0.12	0.48	0.68	0.06

Intersection Summary

APPENDIX G

North Spectrum Loop West Access Exhibits

K:\08132001\18132001 - Spectrum and Voyager\Project\18132001\18132001.dwg
This drawing is a computer-generated drawing and does not represent an actual site. It is for informational purposes only and should not be used for construction or other purposes without the written consent of the engineer of record.

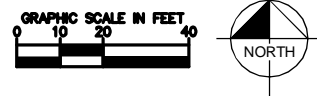
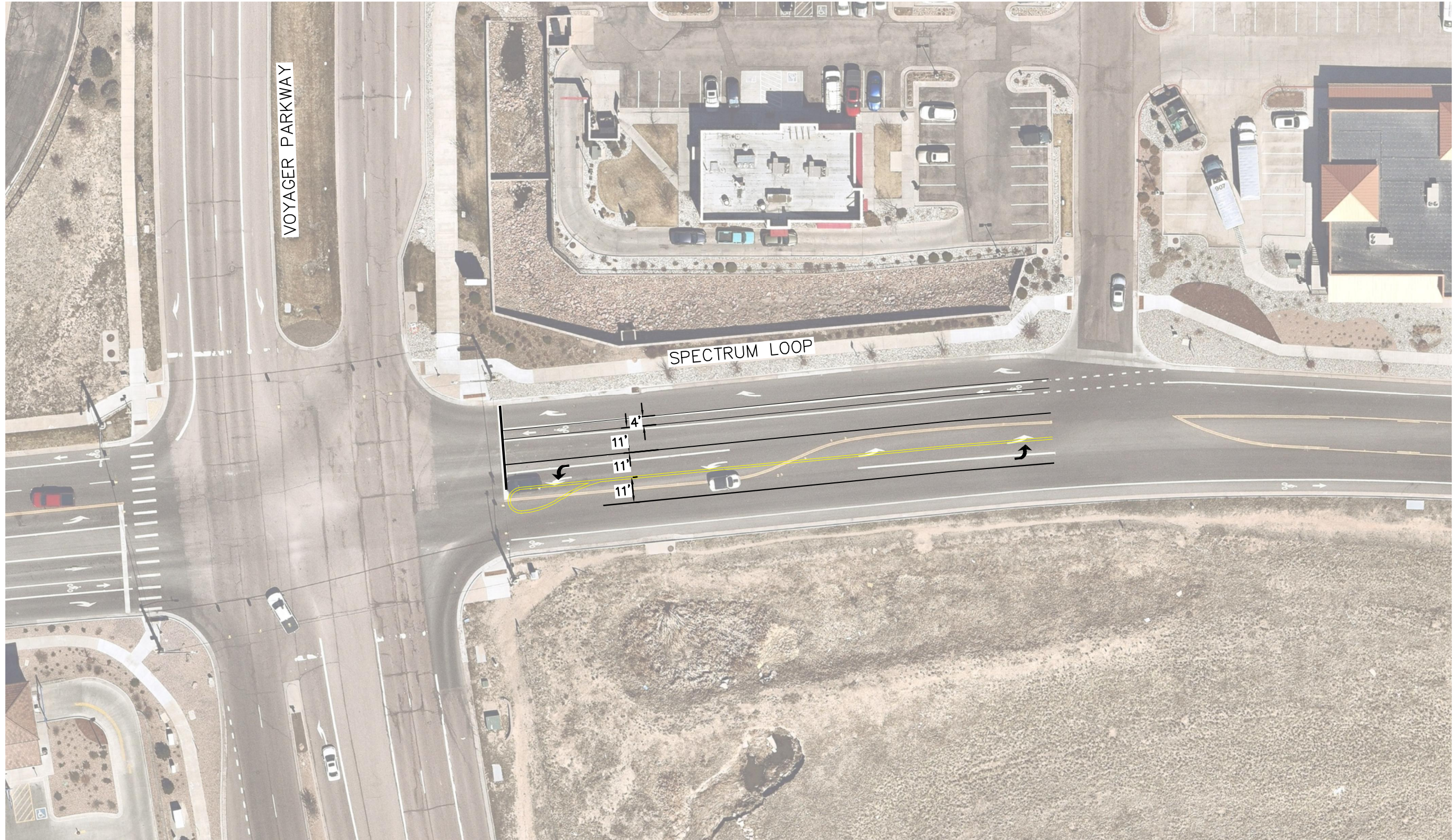

OPTION A: SIDE-BY-SIDE LEFT TURNS

EXHIBIT A

Kimley»Horn
© 2019 KIMLEY-HORN AND ASSOCIATES, INC.
4582 SOUTH ULSTER STREET, SUITE 1500, DENVER, CO 80237
PHONE: 303-228-2300

APPENDIX H

Conceptual Site Plan

Project Information

Address:
 Parcel Number:
 City: Colorado Springs, CO
 County: El Paso County
 Current Zoning: Agriculture
 Proposed Zoning: PUD

Site Summary

Site Area: ±12.7 acres
 Development Area*: ±11.9 acres
 *excludes 0.8 ROW dedication

Units: 3-Story with Tuck-Under Parking:

- 102 units - 1bd - 715sf
- 166 units - 1bd - 800sf
- 22 units - 2bd - 1100sf
- 36 units - 2bd - 1260sf
- 18 units - 3bd - 1350sf
- 344 units**

Development Density: ±28.9 du/ac

Parking Required:

1bd: 268 units x 1.5 sp/unit = 402 spaces
 2bd: 58 units x 1.7 sp/unit = 98.6 spaces
 3bd: 18 units x 2.0 sp/unit = 36 spaces
Total = 536.6 spaces

Parking Provided:

208 garages
 338 parking
546 spaces

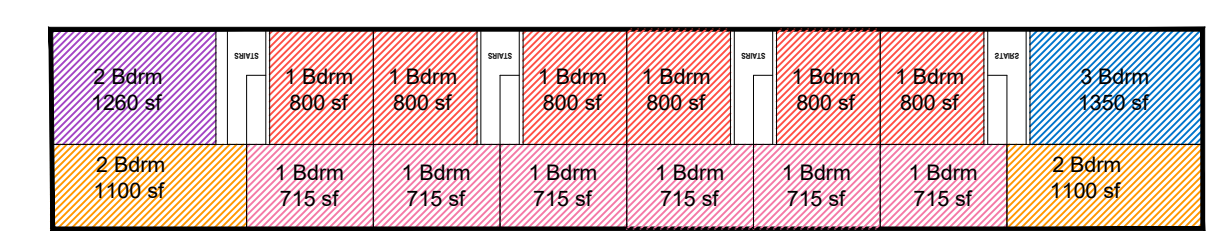
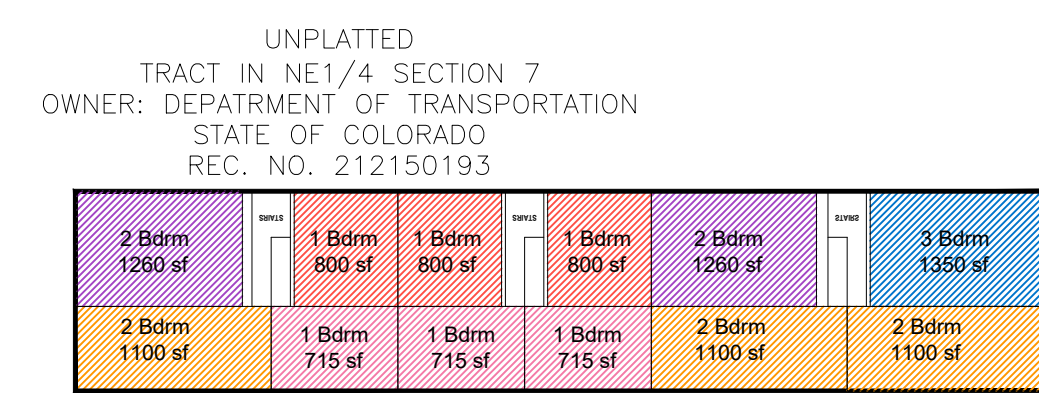
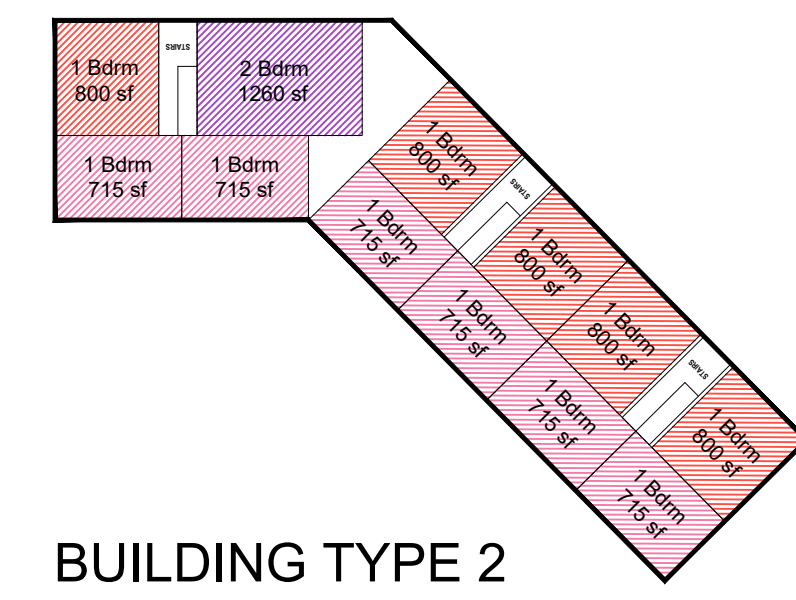
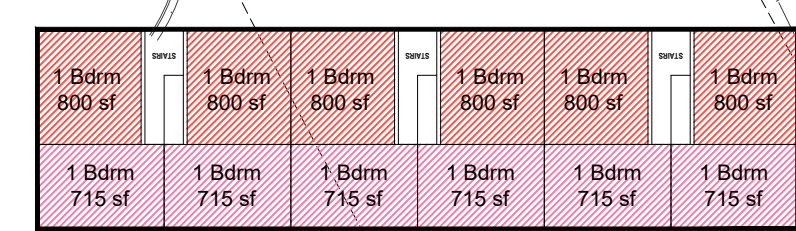

Architecture + Planning
 820 16th Street, Suite 500
 Denver, CO 80202
 303.825.6400
 ktgy.com

MORGAN GROUP
 201 Fillmore St, Ste 205
 Denver, CO 80206

VOYAGER & SPECTRUM LOOP - COLORADO SPRINGS
 COLORADO SPRINGS, CO # 2021-1256

OPTION 19
CONCEPTUAL SITE STUDY
 SEPTEMBER 2, 2022

