

RESOLUTION NO. 19-19

A RESOLUTION ADOPTING THE MILL STREET NEIGHBORHOOD PLAN, REPLACING THE 2003 MILL STREET PRESERVATION PLAN AND EXPANDING THE NEIGHBORHOOD'S GEOGRAPHIC SCOPE

WHEREAS, community stakeholders, citizens, property owners, staff from the City of Colorado Springs ("City"), and the City's consultants have engaged in a rigorous, comprehensive, inclusive, transparent and collaborative planning process which has resulted in the Mill Street Neighborhood Plan (the "Plan"); and

WHEREAS, the Plan helps accomplish the Community Development Division's ("CDD") goals of stabilizing struggling neighborhoods and creating and preserving affordable housing in Colorado Springs; and

WHEREAS, the Plan is an eligible activity as defined by CDBG program regulations under CFR 570.205(a) and meets a national objective of benefitting low- and moderate-income persons as required in CFR 570.200(c); and

WHEREAS, the Plan is a document reflective of its stakeholders, produced throughout months of public engagement going above and beyond the requirements of CDD's Citizen Participation Plan; and

WHEREAS, the Plan took into account the research and vision expressed in a number of studies, such as the CityGate URA Study, the Downtown Transit Station Relocation Study, the Greenway Flats Market Study; and

WHEREAS, the Plan is consistent with current and ongoing community plans, including the City's 2001 Comprehensive Plan, the upcoming comprehensive plan "PlanCOS", the Experience Downtown Master Plan, the upcoming Historic Preservation Master Plan, Park System Master Plan, the Colorado Springs Bike Master Plan; and

WHEREAS, on October 18, 2018, pursuant to City Code § 7.5.407, the City of Colorado Springs City Planning Commission held a public hearing and found that the Plan is consistent with the Comprehensive Plan of the City of Colorado Springs and recommended its adoption; and

WHEREAS, the City Council has considered the evidence presented in support of and in opposition to the Plan, the Staff Report, the Plan and its appendices, the fiscal impact analysis, the City's Comprehensive Plan, the Downtown Review Board endorsement, the City Planning Commission recommendation, City staff recommendations, and has given appropriate weight to the evidence.

NOW, THEREFORE, BE IT RESOLVED BY THE CITY COUNCIL OF THE CITY OF COLORADO SPRINGS:

Section 1. The above and foregoing recitals are incorporated herein by reference and are adopted as findings and determinations of the City Council.

Section 2. City Council desires to recognize the level of attention and analysis given to this effort and acknowledge the participation and high level commitment of the participants in this community process.

Section 3. City Council finds that the Plan substantially conforms to the review criteria contained in City Code § 7.5.408 and hereby approves the Plan.

Section 4. City Council supports the utilization of the Plan in conformance with the directives of City Code § 7.5.401 to encourage coordination in the provision of City capital improvements and to analyze the impact of proposed development on public facilities and environmental quality;

Section 5. City Council further recommends that upon adoption, this Plan also be used as appropriate to guide and inform the community with respect to City Strategic Plan goals and objectives, updates to other planning studies, any necessary ordinances, and for the pursuit of future funding mechanisms in support of the Plan.

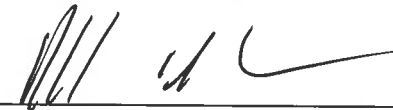

Section 6. This resolution shall be effective upon its approval by City Council.

Dated at Colorado Springs, Colorado this 12th day of February, 2019.



Council President

ATTEST:

Sarah B. Johnson, City Clerk

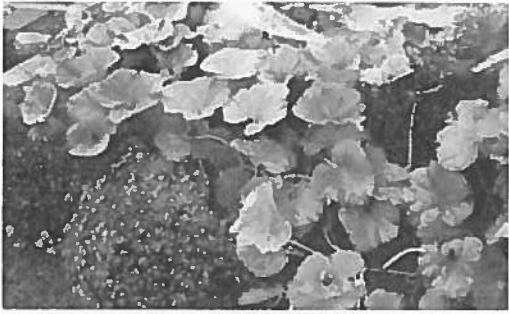

MILL STREET NEIGHBORHOOD PLAN



PLAN FOR ADOPTION: FEBRUARY 12, 2019

ACKNOWLEDGMENTS

This plan would not have been possible without the dedication and wisdom of our community partners, who guided and advised the agency partners throughout the process.

LOCAL PARTNERS

Council of Neighbors and Organizations
The Independence Center
Historic Preservation Alliance of Colorado Springs
Springs Rescue Mission
Pikes Peak Habitat for Humanity
Amy Filipiak and students, Pikes Peak Community College

MILL STREET NEIGHBORHOOD ASSOCIATION

Linda Clemons
Karen Hess
Jeff Hovermale
Ramona Lidmila
Laurie Price
Ray Quinn
Sandy White
Denise Wilson
Joanne Zeigler

CITY OF COLORADO SPRINGS

Catherine Duarte, Community Development
Paul Morrow, Community Development
Steve Posey, Community Development
Matthew Fitzsimmons, Planning
Ryan Tefertiller, Planning
Conrad Olmedo, Planning
Katie Sunderlin, Neighborhood Services
Officer Sid Santos, Police
Sgt. Curt Hasling, Police/Homeless Outreach Team
Kurt Schroeder, Parks, Recreation & Cultural Services
Brian Vitulli, Mountain Metro

ELECTED OFFICIALS

Mayor John Suthers
District 1: Don Knight
District 2: David Geislinger
District 3: Richard Skorman, Council President
District 4: Yolanda Avila
District 5: Jill Gaebler, President Pro-Tem
District 6: Andy Pico
At-large: Merv Bennett
At-large: Bill Murray
At-large: Tom Strand

CONSULTANT TEAM

Design Workshop, Inc.
Anna Laybourn, Principal
Cali Pfaff, Associate
Kathleen King, Associate
Amanda Jeter, Associate
FHU Engineering
Todd Frisbie, Senior Transportation Engineer
Bachman PR
Lisa Bachman, Principal

DESIGNWORKSHOP

All photos courtesy of the City of Colorado Springs and Design Workshop, Inc. unless otherwise noted.

CONTENTS

EXECUTIVE SUMMARY	2
HOW TO USE THIS PLAN	4
INTRODUCTION	7
Welcome to Mill Street	8
Planning Context	6
Public Outreach	10
Glossary	14
EXISTING CONDITIONS	17
Study Area	19
Neighborhood Character	20
Demographics	22
Housing & Affordability	23
Economics	25
Local Challenges	26
Transportation & Mobility	28
Parks & Open Space	31
PLAN CONCEPTS & RECOMMENDATIONS	33
Vision & Goals	34
Enhance Quality of Life for Mill Street Residents	36
Cultivate Mill Street Character	40
Reconnect Mill Street People & Places	44
Create a Resilient Future for Mill Street	48
Big Moves	52
ACTION PLAN	57
APPENDICES	70
Community Engagement	A
Supplemental Maps	B
Literature Review	C
Implementation Tools	D
Resolution	E

EXECUTIVE SUMMARY

WHAT IS THE NEIGHBORHOOD PLAN?

The idea of creating a Mill Street Neighborhood Plan came about over a series of community meetings in 2015 during the negotiations for a Good Neighbor Agreement between the Mill Street Neighborhood Association, Springs Rescue Mission, and the City of Colorado Springs.

The expansion of the shelter triggered a demand for more tools to protect the neighborhood character and safety, but it quickly became clear that an update to the 2003 Mill Street Neighborhood Preservation Plan was necessary for reasons beyond the shelter.

The Mill Street Neighborhood has endured for nearly 150 years. In that time, homes have been lost to accommodate dump sites, coal power plant construction and operation, industrial warehouses, and rail line additions. As Colorado Springs development has spread out in every direction over the last few decades, this central community has weathered the closures of schools, grocery stores, and other neighborhood hubs and services.

Downtown Colorado Springs and adjacent neighborhoods are now welcoming an insurgence of new investment and the Mill Street community is seeing an influx of associated challenges and opportunities. While many welcome a revitalization of the area, maintaining the ability to afford to stay in the area and reducing crime and unsafe street activity remain top concerns. The Mill Street Neighborhood Plan is an expression of its residents' and workers' sentiments that it is not enough to just survive in this new climate, but to thrive.

PROCESS

Over the course of the planning process, community members shared their vision and concerns about the neighborhood, weighed in on project themes, and helped guide the recommendations. Community engagement focused on a four-tiered approach: reach out, listen, engage and share.

VISION

Through an inclusive and consensus-building process, the Mill Street Neighborhood Plan will set the stage for the future of the Mill Street community to be a thriving, dynamic place that celebrates its diversity and historic past.



TOP TO BOTTOM:
NEIGHBORHOOD MEETING 2018
AREA BOUNDARY MAP 1: 2,500

GOALS

The Plan is a celebration of Mill Street's past and a statement of resilience. Months of listening to and engaging with the neighborhood produced recurring themes best characterized by the four categories below.



1 *Enhance the Quality of Life for Mill Street Residents*

PAGE 36



2 *Cultivate Mill Street Character*

PAGE 40



3 *Reconnect Mill Street People & Places*

PAGE 44



4 *Create a Resilient Future for Mill Street*

PAGE 48

THE ACTION PLAN

While the Goals represent the big picture ideas and outcomes, the Action Plan lays out specific strategies for reaching those goals. It includes short descriptions of the steps, the parties and partners best equipped to take the lead, the relative costs of implementation, potential sources of funding, and the estimated time for completion. This section is meant to be a living document to be used, updated, and improved upon by all community stakeholders. The Action Plan will guide implementation and monitoring for the implementation team, which is made up of citizens, advocates, and City staff. If you are interested in joining the implementation team, contact communitydevelopment@springsgov.com!

HOW TO USE THIS PLAN

ORIENTATION

The Mill Street Neighborhood is a special place that has played an important role in the evolution of Colorado Springs. Few American cities have retained their historic workforce neighborhoods in the downtown core, but this one has carried on for 150 years.

The purpose of plan is to be intentional about the future evolution of this neighborhood: encouraging redevelopment of vacant and unused properties in harmony with the neighborhood culture and celebrating its history.

It is expected the Mill Street Neighborhood Plan will be used by a wide array of community members, from residents to city staff and developers. The plan provides a framework for future capital projects, organizational assistance, program opportunities, and land use considerations.









MILL STREET & ADJACENT DISTRICTS

While there is overlap between the Downtown study area from the 2016 Experience Downtown Master Plan and the Mill Street Neighborhood study area, the recommendations and land use planning herewithin align. In areas that overlap, Mill Street is considered a subarea of the Downtown.

Also within areas of overlap, there is latitude for a tenant or land owner to align with either district's plan. In addition, areas that are primarily non-residential overlap are within sectors of the Downtown form-based code that governs use and future development of land.

Just northwest of the Mill Street area is the CityGate Urban Renewal site, established in 2006. In the summer of 2018, the City announced a public-private partnership to site a new Colorado Springs Switchbacks stadium/outdoor event center and apartment building on the CityGate property. The Colorado Springs Urban Renewal Authority expects to update the CityGate plan.

LEGEND

- EXPERIENCE DOWNTOWN
 -  Southwest District
 -  New South End District
 -  ED Boundary
- FORM-BASED CODE (FBC)
 -  Central Sector
 -  Corridor Sector
 -  Transition Sector 1
 -  Transition Sector 2
- MILL STREET PLAN
 -  Parks & Open Space
 -  River / Creek
 -  Major Roads
 -  Project Boundary

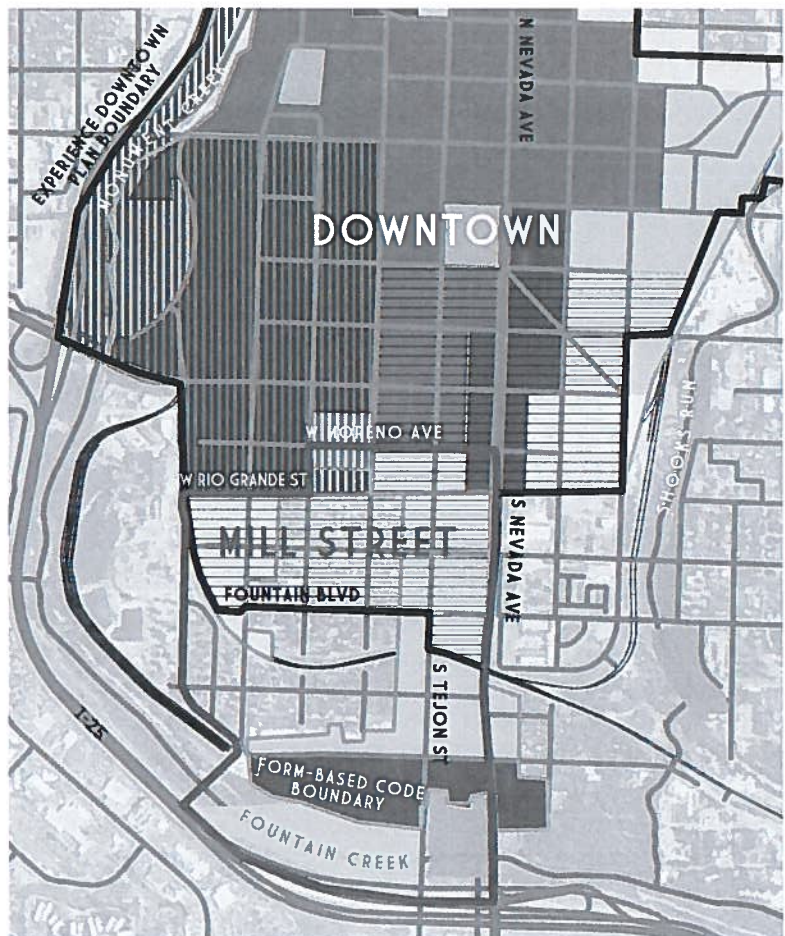

PROJECT ALIGNMENT

Are you proposing a land use change and/or new development in the neighborhood?

For new development projects, the table below summarizes plan elements for consideration. It is not expected that all these categories or questions will apply to a single project. These questions are intended to help create an understanding of the proposed development. To determine whether your development plans align with the Mill Street Neighborhood Plan, here are questions to consider in development applications.

Enhance the Quality of Life for Mill Street Residents	Cultivate Mill Street Character	Reconnect Mill Street People and Places	Create a Resilient Future for Mill Street
How will this project contribute to the safety and public health of the neighborhood?	How will this project highlight the neighborhood’s history and/or complement the area’s architectural styles?	How has the project owner engaged with the neighborhood during the project planning phase?	How has this project considered affordability in the neighborhood?*
Will this project provide public gathering spaces?	How will the project’s proposed density impact the surrounding uses?	How does this project provide/complement pedestrian accessibility?	Will this project create employment opportunities for local residents?
How does this project impact the environment?	Does this project preserve residential structures?	How does this project promote street vitality?	How will this project address retention of current residents?
		Will this project activate previously vacant or underutilized space?	Will this project provide or support a land use/service that fills a need in the neighborhood?

* For more information on affordable housing incentives and other financing tools, please see Appendix D.

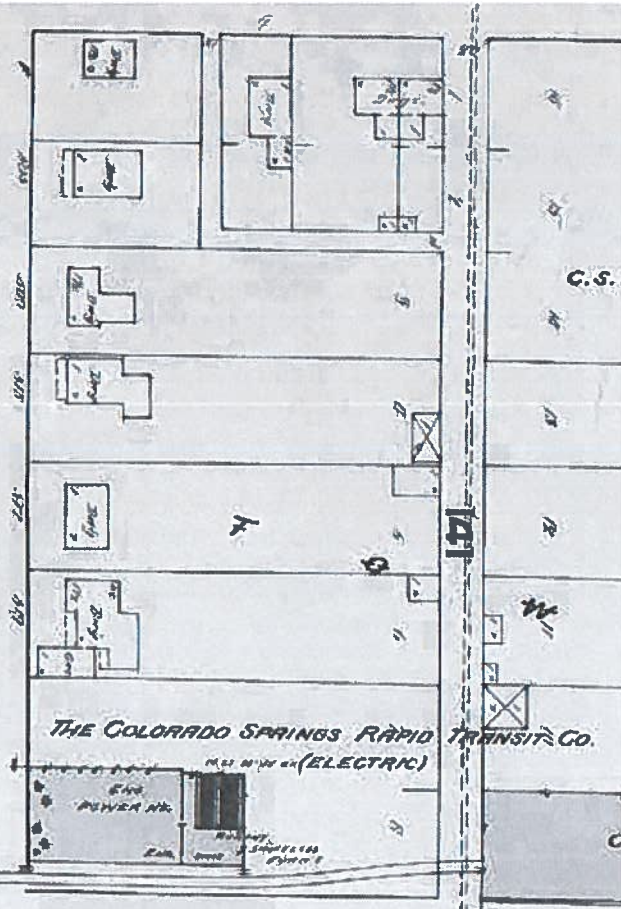
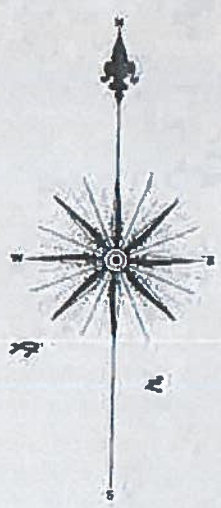
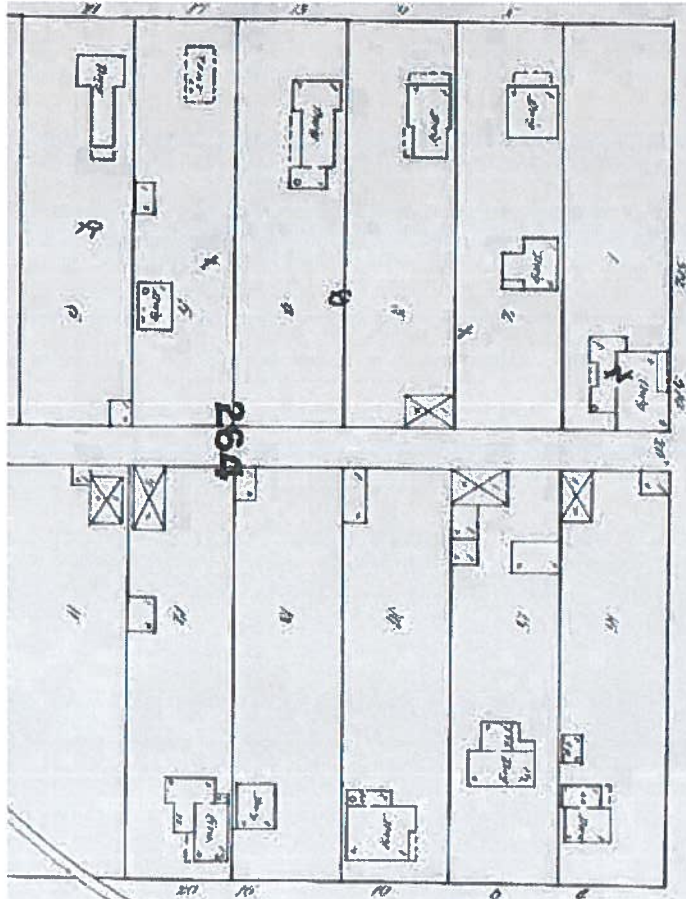

W. MORENO

E. MORENO

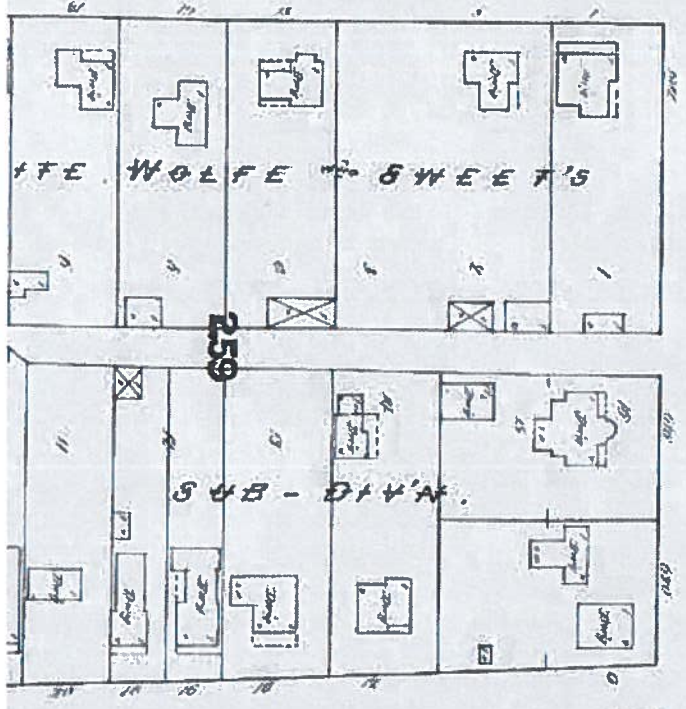

S. CASCADE AV.

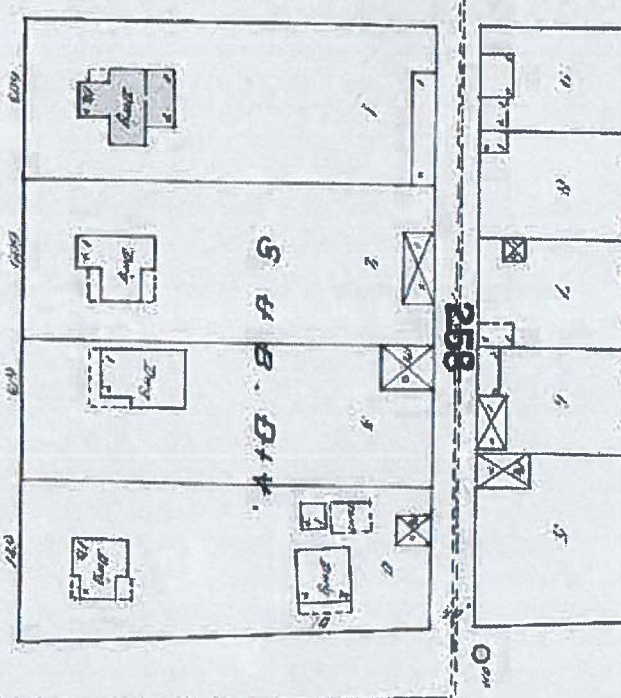

W. RIO GRANDE

E. RIO GRANDE

EXCERPT FROM SANBORN MAPS 1900

COLORADO

SPRINGS

100'

INTRODUCTION

CONTENTS

Introduction

Community Engagement Overview

Community Engagement Takeaways

Glossary

INTRODUCTION

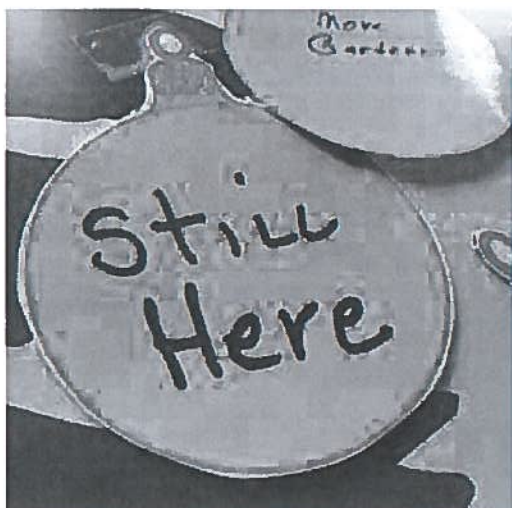

TOP TO BOTTOM:
VIEW TO MOUNTAINS
RESIDENT WISH FOR THE NEIGHBORHOOD

WELCOME TO MILL STREET

Located just south of Downtown Colorado Springs, the Mill Street Neighborhood is one of the oldest communities in the city.

General William Palmer platted the neighborhood area in 1870, a full year before Colorado Springs was established at the confluence of Fountain and Monument Creeks (located north of the study area). Mill Street got its name from the gristmill built in 1877 at the tail end of Cascade Ave off Fountain Creek. The mill was regionally famous for producing the best wheat and graham flour west of the Mississippi.

Due to its proximity to Downtown and the burgeoning Broadmoor resort, the Mill Street Neighborhood became a working-class district for employees of the more affluent areas to the North and South. The neighborhood was formally annexed into the City of Colorado Springs in 1907. Throughout the 20th century, the area's residential stock decreased as land was purchased for the railroad and industrial land. At the time of the 2003 Mill Street Neighborhood Preservation Plan, there were a number of multigenerational households whose ancestors had grown up in the area. Today the neighborhood includes an eclectic mix of small homes, local-serving retail, and industrial uses. Approximately 800 people call this neighborhood their home.

PLANNING CONTEXT

As a city-center neighborhood in Colorado Springs, the Mill Street Neighborhood has been involved in many local planning initiatives dating back to the early 1970s.

Beginning with the Downtown Plan in 1971 and later the 1992 Downtown Action Plan, the City of Colorado Springs has been strategically planning the revitalization of its Downtown for decades. The first major plan to specifically address the Mill Street area was the 2003 Mill Street Neighborhood Preservation Plan. The study boundary of the 2003 plan focused in on the residential core, bounded by Tejon Street to the East, W. Fountain Boulevard to the North, Conejos Street to the West and W. Las Vegas Street to the South. The plan sought to safeguard the historic character, preserve the existing residential stock, organize a program to promote home ownership and cement the identity of the area as a working-class neighborhood.

In recent years, targeted planning initiatives have set the stage for incremental change.

As these incremental changes pick up in pace and scale, the area will look to a significant catalytic change with the closure of Martin Drake Power Plant by 2035.

In the 2009 [Imagine Downtown Master Plan](#) (and the 2016 follow-up plan, [Experience Downtown](#)), the northern portion of Mill Street was in the study area, included in two Downtown character zones. (More detail on page 18). Separate from the Mill Street area yet heavily influential is the CityGate Urban Renewal Area, which includes a new outdoor stadium. After many years of planning, initial plans were announced in July 2018 to develop a 10,000-seat outdoor stadium for the Switchbacks, Colorado Springs' minor league soccer team, as well as hundreds of apartments and a mixed use development. The project will be financed from a combination of public and private investment.

The 2009 adoption of the [Downtown Colorado Springs Form-Based Code](#) (FBC) has the potential to impact building form and density in the Mill Street neighborhood through new development. The code is a regulatory measure used to enact the vision of the Imagine Downtown Master Plan by focusing on quality built form and mixed use development. Previously, the City employed traditional zoning, which designated land uses to segregate types of development.

Influential planning and private development projects, such as the US Olympic Museum, have impacted the area in and around the Mill Street neighborhood. In Mill Street, there is a tension between the high-end developments along Tejon and North of the study area and the social services expanding in the South of the study area. This tension manifests in divisions in income and investment based on which side of the train tracks one is on, isolating many members of the community and fueling concerns of displacement and neglect.

In 2019, the City will complete an updated comprehensive plan, which lends urgency and legitimacy to the role of neighborhood plans to address these problems. The Mill Street Neighborhood Plan aims to fulfill PlanCOS's vision of vibrant neighborhoods by creating a place for all by encouraging inclusion, participation, housing for all price points, and reinvestment in community spaces.¹

¹ City of Colorado Springs. *PlanCOS Draft. "Vibrant Neighborhoods: Goals & Policies." 2018.*

1970s

Downtown Plan 1971

1990s

Downtown Action Plan 1992

Downtown Transit Center Study 1998

2000s

City of Colorado Springs Comprehensive Plan 2000

Mill Street Neighborhood Preservation Plan 2003

CityGate URA Studies 2006

Imagine Downtown Master Plan 2009

Downtown Colorado Springs Form-Based Code 2009

2010s

Colorado Springs Park System Master Plan 2014

South Nevada Corridor Study 2015

Experience Downtown Master Plan 2016

Downtown Transit Station Relocation Study 2016

Opportunity360 Measurement Report 2016

Greenway Flats Market Study 2016

Envision Shooks Run Corridor Master Plan 2017

Colorado Springs Bike Master Plan 2018
PlanCOS 2018

COMMUNITY ENGAGEMENT OVERVIEW

PUBLIC OUTREACH

The Mill Street Neighborhood Plan is an effort informed and inspired by community members.

Over the course of the planning process, community members shared their visions and concerns about the neighborhood, weighed in on project themes, and helped guide the recommendations. **Community engagement focused on a four-tiered approach: reach out, listen, engage and share.**

Low attendance at meetings that impact the neighborhood, such as the Neighborhood Association meetings, made it clear that traditional outreach and communication methods would not be effective. One measure of success from this public engagement process is the fact that 35 highly supportive residents attended a Neighborhood Association meeting at the end of the process as a result of outreach tailored to individually reach out to residents and business owners.

Throughout November 2017, the project team conducted community listening sessions to engage residents, homeowners, employees and businesses owners at locations throughout the Mill Street neighborhood. These sessions were topical in nature, covering Neighborhood Historic Preservation, Economic Development and Local Business, Affordable Housing,

Neighborhood Safety: Street Crossings and, Parks, Trails and Open Space and Arts and Culture.

In December 2017, the project team launched a community-wide, public survey. The survey offered an opportunity to weigh in on 12 key questions shaping the future of the Mill Street Neighborhood. Outreach for the survey included social media, door-to-door outreach and postcards. Nearly all of the business owners received a personal visit from a member of the project team and many residents were visited by Christmas carolers. In total, there were 78 responses to the survey, roughly 10% of the area's resident population. Nine local stakeholders, including residents, business owners and developers, were then interviewed one-on-one to better understand the conditions in the neighborhood and any planned changes.

With initial themes and recommendations in development, the planning team engaged an implementation team in small group discussions. The team includes City employees, residents, business owners and subject matter experts.

In March 2018, the planning team hosted a public meeting at the Hillside Community Center. Over seventy people attended. The presentation included initial findings and live polling questions to provide further quantitative feedback on themes and draft recommendations. The session ended with an open house where attendees socialized, shared ideas and participated in visual preference surveys.

2017

2018

PROJECT KICKOFF

INVENTORY + ANALYSIS

DEVELOPING RECOMMENDATIONS

PLAN DOCUMENTATION

SEP

OCT

NOV

DEC

JAN

FEB

MAR

APR

COMMUNITY LISTENING SESSIONS

COMMUNITY SURVEY

STAKEHOLDER INTERVIEWS

PUBLIC MEETING +
COMMUNITY INPUT ANALYSIS



50

HOMES & BUSINESSES VISITED BY CHRISTMAS CAROLERS



78

SURVEYS COMPLETED

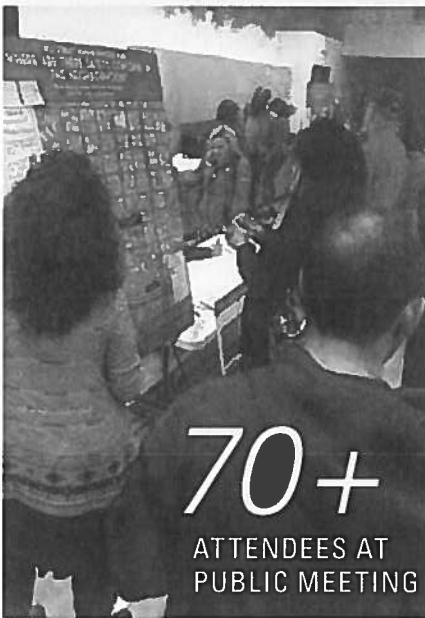

70+

ATTENDEES AT PUBLIC MEETING



69

PARTICIPANTS IN 6 SMALL GROUP LISTENING SESSIONS

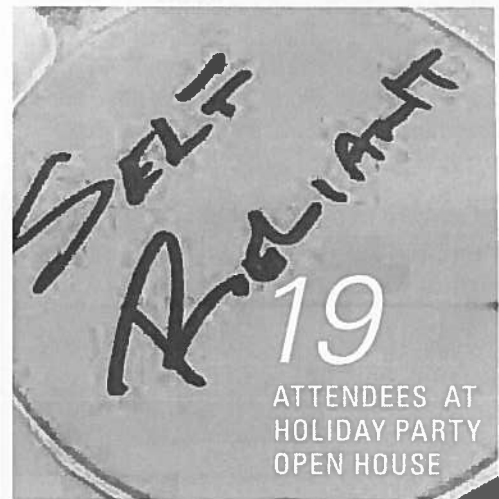

ATTENDEES AT HOLIDAY PARTY OPEN HOUSE



ONE-ON-ONE STAKEHOLDER INTERVIEWS

"Improve quality of life while maintaining historic value and affordability."

- Comment Card

(SOURCE: PUBLIC MEETING)

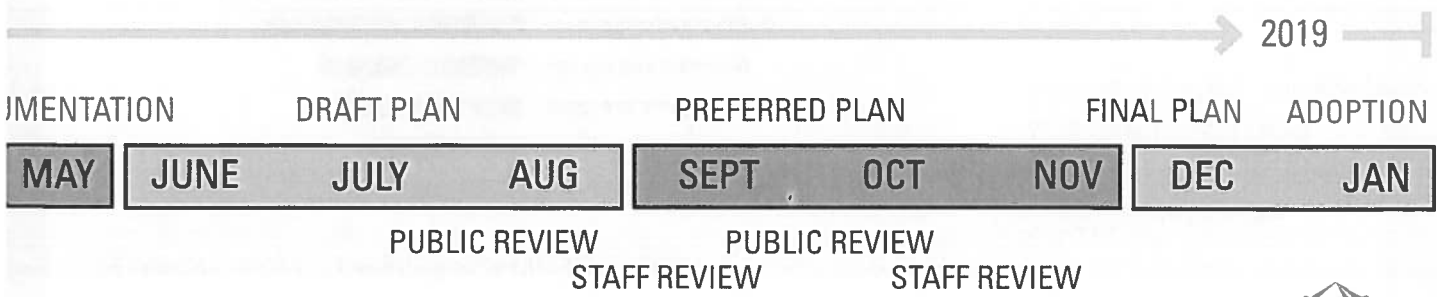

COMMUNITY ENGAGEMENT TAKEAWAYS

The planning team conducted extensive community engagement through four methods. Below are key takeaways.

COMMUNITY LISTENING SESSIONS

There were seven listening sessions each with its own focus area. Key attributes that the group thought the plan should speak to are recorded below.

ARTS & CULTURE—Maintain neighborhood feeling, create historic overlay zone, preserve architecture, make neighborhood walkable

AFFORDABLE HOUSING—Preserve historic homes, diversify housing, incentivize homeownership, stabilize rents

ECONOMIC DEVELOPMENT—Control affordability, create business identity, address food desert, create safer environment

HISTORIC PRESERVATION—Make walkable neighborhood, preserve working class character, preserve heritage, create special outdoor spaces

PARKS, OPEN SPACES AND TRAILS—Maintain trails and bike paths, increase greenway safety, create eyes on the trail

COMMUNITY SAFETY—Increase policing, reduce speeding, enforce rules, collaborate with Springs Rescue Mission, mobilize residents for greater communication

HOMELESS OUTREACH—Provide secure storage space for belongings, offer daytime programming and job opportunities

IMAGES AT RIGHT FROM PUBLIC MEETING:
 COMMENTS ON SAFETY
 VISUAL PREFERENCE RESPONSES
 OPEN HOUSE GUESTS

COMMUNITY SURVEY

Outreach for the community survey involved door-to-door visits to local businesses and Christmas caroling for residents. With about 10 percent of the population participating (78 surveys completed), residents (both long-term and short-term) and business owners/employees were all represented. Top priorities included a reduction in crime and nuisance, improved look and feel; affordability; support for existing businesses and better communication between residents and the City. Write-in responses indicated strong concern about homelessness and safety. The full report can be found in Appendix A.

What do you think are the most important outcomes for a successful neighborhood plan?

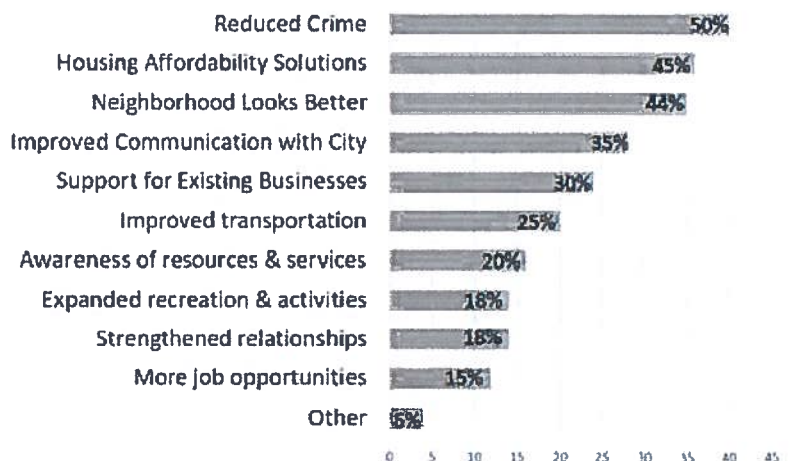

What amenities would make the greatest contribution to the sense of community if added?

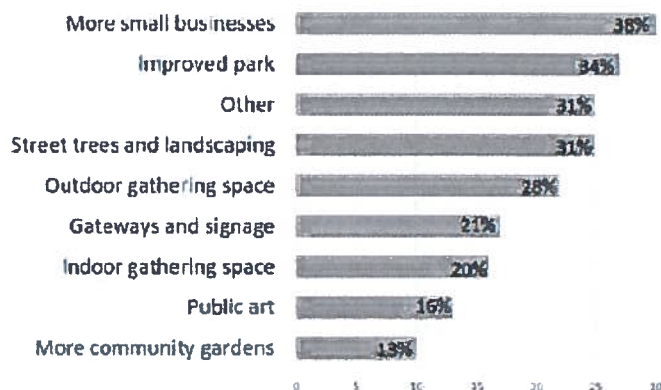

(SOURCE: COMMUNITY SURVEY, 78 RESPONDENTS)



PUBLIC MEETING

There were 70 attendees, ranging from City staff to local business owners, with a smaller percentage representation of residents than the survey. Community members identified the following action items via live polling and during the open house.

UPGRADE INFRASTRUCTURE—The poor condition of the neighborhood’s sidewalks and roadways was a key neighborhood concern. 70% of attendees identified ‘condition of infrastructure’ as a top priority for improvement.

COLLABORATE TO IMPROVE SAFETY—Safety is a core concern in the neighborhood and attendees selected a wide array of strategies for how to improve it, such as more support for those experiencing homelessness and a more proactive and responsive approach to policing.

SUPPORT CLEANUP EFFORTS—Both in the live polling and on comment cards, trash and debris in the neighborhood and along trails were notable concerns. 70% of attendees indicated that trash and debris negatively impact the neighborhood.

REIMAGINE DORCHESTER PARK—When asked what should be done with Dorchester Park, 69% of attendees advocated for major changes.

THE FUTURE—When asked “What possible 20+year changes could be most beneficial to the neighborhood?” 57% of respondents indicated decommissioning of the Drake Power Plant.

STAKEHOLDER INTERVIEWS

A series of one-on-one interviews were conducted with community stakeholders to delve into specific issues about the neighborhood. Key takeaways were that outside business owners do not feel a strong connection to the neighborhood, property owners need further consultation in implementation, safety concerns impact residents as well as businesses, and a strong messaging about neighborhood identity would bolster the area.

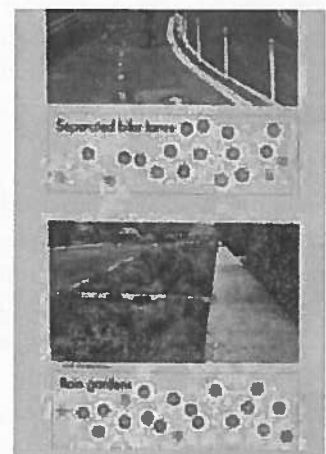
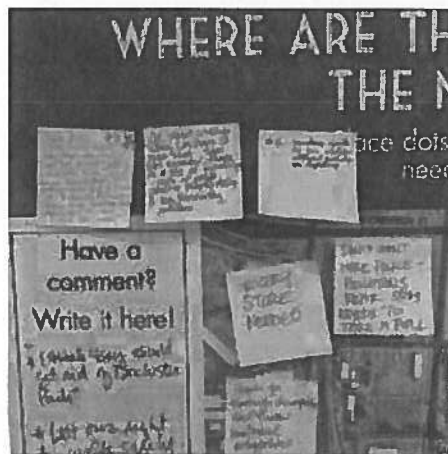

GLOSSARY

ACCESSORY DWELLING UNIT (ADU)

Accessory dwelling units (ADUs)—also referred to as accessory apartments, second units, or granny flats—are additional living quarters on single-family lots that are independent of the primary dwelling unit. The separate living spaces are equipped with kitchen and bathroom facilities, and can be either attached or detached from the main residence.¹

PLANNED UNIT DEVELOPMENT (PUD)

The term “Planned Unit Development” describes a type of development, as well as the regulatory process itself, that permits a developer to meet community land use goals without being bound by existing zoning requirements.²

OVERLAY ZONES

An overlay zone is a zoning district which is applied over one or more previously established zoning districts, establishing additional or stricter standards and criteria for covered properties in addition to those of the underlying zoning district. Communities often use overlay zones to protect special features such as historic buildings, wetlands, steep slopes, and waterfronts. Overlay zones can also be used to promote specific development projects, such as mixed use developments, waterfront developments, housing along transit corridors, or affordable housing.³

AFFORDABLE HOUSING

In general, housing for which the occupant(s) is/are paying no more than 30 percent of his or her income for gross housing costs, including utilities. Please note that some jurisdictions may define affordable housing based on other, locally determined criteria, and that this definition is intended solely as an approximate guideline or general rule of thumb.⁴



TOP TO BOTTOM:
MILL STREET SIDEWALK
BUSINESSES ON LAS ANIMAS STREET

1 *Municipal Research and Services Center of Washington, Accessory Dwelling Units, October 1995, <http://mrsc.org/getmedia/54c058a5-4d57-4192-a214-15f2fa5ac123/ADU30.pdf.aspx>*

2 *Beyer, Paul. Planned Unit Development. Livable New York Resource Manual. <https://aging.ny.gov/LivableNY/ResourceManual/PlanningZoningAndDevelopment/112j.pdf>*

3 *American Planning Association. Property Topics and Concepts. <https://www.planning.org/divisions/planningandlaw/propertytopics.htm#Overlay>*

4 *US Department of Housing and Urban Development. Glossary. https://www.huduser.gov/portal/glossary/glossary_a.html*

COMMUNITY LAND TRUST

A Community Land Trust (CLT) is a nonprofit organization—governed by a board of CLT residents, community residents and public representatives—that provide lasting community assets and permanently affordable housing opportunities for families and communities. CLTs develop rural and urban agriculture projects, commercial spaces to serve local communities, affordable rental and cooperative housing projects, and conserve land or urban green spaces. CLTs create homes that remain permanently affordable, providing successful homeownership opportunities for generations of lower income families.⁵

MIXED USE DEVELOPMENT

A mixed use development is a real estate project with planned integration of some combination of retail, office, residential, hotel, recreation or other functions. It is pedestrian-oriented and contains elements of a live-work-play environment. It maximizes space usage, has amenities and architectural expression and tends to mitigate traffic and sprawl.⁶

URBAN RENEWAL AREA (URA)

The Colorado Springs Urban Renewal Authority (CSURA) has authorized several Urban Renewal sites within the downtown core, including Southwest Downtown, Citygate and City Auditorium Block. The CSURA supports projects that supply public benefit, provide quality sustainable places, create jobs, promote public art, offer affordable housing and raise the standard of development in Colorado Springs through tax increment financing tools.⁷



TOP TO BOTTOM:

VIEW OF RAILLINES

TEJON COMMERCIAL STREET

⁵ FAQ. National Community Land Trust Network. cltnetwork.org/faq/

⁶ What Exactly is Mixed Use? Four Leading Associations Provide Industry-Wide Definition for Mixed use Development. [https://www.icsc.org/uploads/research/general/Mixed use_Definition.pdf](https://www.icsc.org/uploads/research/general/Mixed_use_Definition.pdf)

⁷ "Districts and Financial Tools" Experience Downtown Colorado Springs. p15. https://downtowncs.com/wp-content/uploads/2017/02/COSdowntown_FinalSM3.pdf

W

15 FR. D.
6 " B.
266

COSTILLO

II

E

267

131

11 FR. D.
132
4 FR. B.

S

W

CIMARRON

E

6 FR. D.
4 " B.
263

264

141

14 FR. D.
10 " B.
142
1 FR. CARP
SHOP

W

MORENO

12

E

WHITE, WOLFE & SWEETS
260
SUB. DIV.

FOOTES
258
SUB-DIV.

FRANCE
257^{FR. D.}_{S. B.}
SUB-DIV.

W.

RIO GRANDE

E

COLORADO

301
9 FR. DW
1 " B.

302
10 FR. D.
6 " B.

SPRING'S

303
12 FR. D.
4 " B.

CO'S

304
11 FR. D.
4 " B.

W.

LAS ANIMAS

E

311

312

313

314

W.

FOUNTAIN

E

321 SPRNGS
322

CO'S
323

ADD'N
324

EXISTING CONDITIONS

Overview
History & Culture
Local Community
Local Economy
Transportation & Mobility
Parks & Open Space

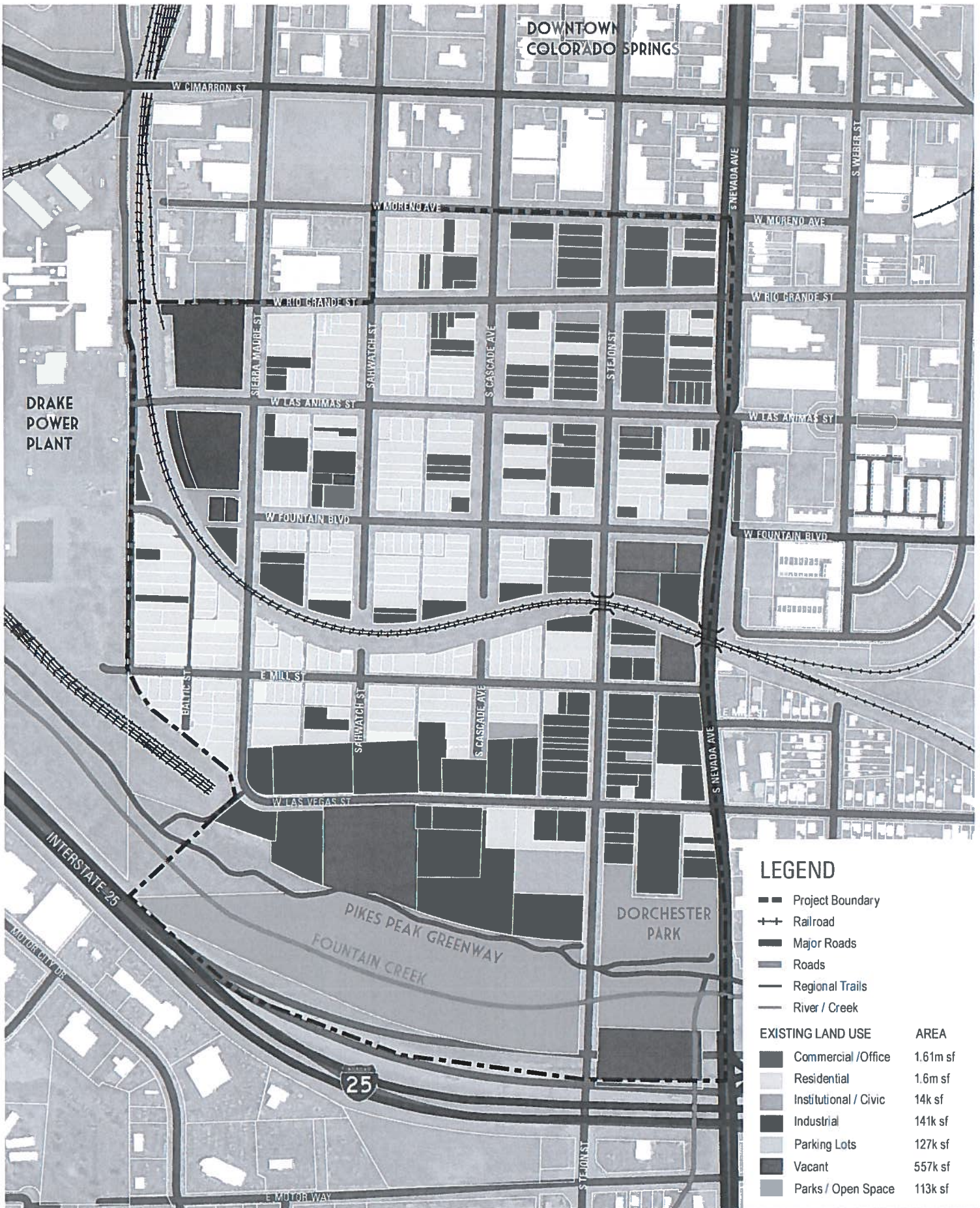

DOWNTOWN
COLORADO SPRINGS

DRAKE
POWER
PLANT

DORCHESTER
PARK

LEGEND

- Project Boundary
- Railroad
- Major Roads
- Roads
- Regional Trails
- River / Creek

EXISTING LAND USE	AREA
Commercial / Office	1.61m sf
Residential	1.6m sf
Institutional / Civic	14k sf
Industrial	141k sf
Parking Lots	127k sf
Vacant	557k sf
Parks / Open Space	113k sf

**MILL STREET NEIGHBORHOOD
EXISTING LAND USE**

250' 500' 1,000' 2,000'



OVERVIEW

STUDY AREA

The Mill Street Neighborhood Plan study area focuses on a 202-acre area south of Downtown Colorado Springs.

The area is bound by W. Moreno Avenue and W. Rio Grande Street to the North, by South Nevada Street—a mixed use arterial to the East, by Conejos Street and Sahwatch Street to the West, and by Interstate 25 to the South. The boundary borders the Urban Renewal Authority CityGate site to the Northwest, which is undergoing redevelopment.

The neighborhood core is a historic residential community. Industrial uses fringe the residential area to the West and South, including the Drake Power Plant, historically a major employer, slated for decommissioning by 2035. According to the 2003 [Mill Street Neighborhood Preservation Plan](#), the residential core has shrunk substantially over time, due first to the conversion of residential land to industrial uses in the late 1980s and later to the purchase of land by Colorado Springs Utilities (CSU) in 1996 to buffer the power plant. As late as 2000, homes south of Mill Street and west of Sierra Madre Street were purchased by CSU to install rail lines to the power plant. The Springs Rescue Mission, on W. Las Vegas Street, expanded its facility to a 300-bed low-barrier shelter in 2016 and is currently expanding their campus to include permanent, supportive housing (PSH), a housing type that provides wraparound services for people with chronic, disabling conditions who have exited homelessness. The Mission is both a regional asset for the City of Colorado Springs and a local challenge with many business owners and some residents expressing concerns about some spillover effects from people engaging in high risk behavior.

The commercial heart of the Mill Street neighborhood is South Tejon Street; South Nevada Avenue, another major commercial corridor, borders the site on the East. Local businesses offer a broad range of services along Tejon Street.

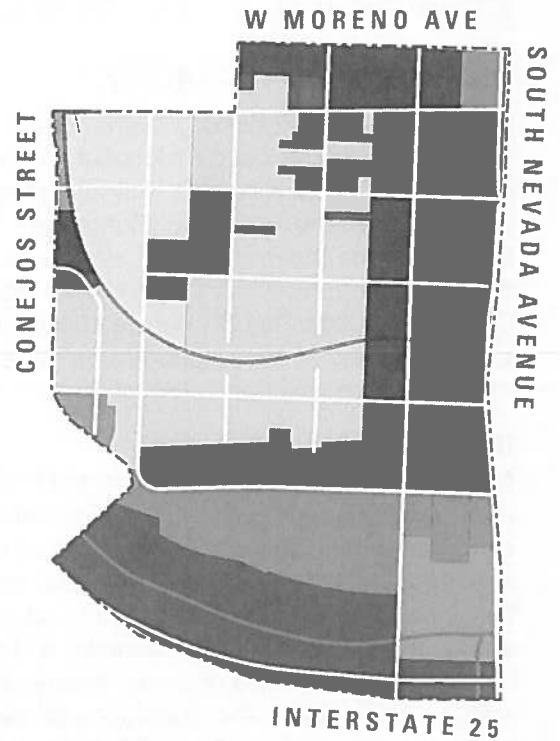

ZONING MAP

- Residential
- Planned Unit Development
- Commercial / Office
- Industrial
- Institutional / Civic
- Parks / Open Space
- Form Based Code: Transition Sector 1
- Form Based Code: Corridor Sector
- Form Based Code: Transition Sector 2



HISTORY & CULTURE

NEIGHBORHOOD CHARACTER

Mill Street is a diverse neighborhood that has continuously acted as a working class residential community since the City's founding. Businesses that help shape the character of the neighborhood include Montague's Parlour, a bar and tea house; the Independence Center, a service provider and community organizer for persons with disabilities; and the Colorado Springs Day Nursery, a children's center that has been operating in the neighborhood since 1923.

URBAN DESIGN

Mill Street has a traditional street grid that makes it a walkable community, though many of the sidewalks are in poor condition or incomplete. Relatively small residential lots have shaped the character of the residential area where there are few structures over one story and most have a small front and back yard. The historic character of the area remains intact with renovations of some historic bungalows into office spaces. The neighborhood includes portions of two Downtown districts from the [Experience Downtown Plan](#). The New South End, including South Tejon Avenue, is characterized by a mix of historic and revitalized industrial, whereas the South West is more contemporary in feel and connects the neighborhood to Downtown and its new civic amenities, such as America the Beautiful Park and the forthcoming US Olympic Museum. These districts overlay the Mill Street neighborhood and add to its character.

ARCHITECTURE

The neighborhood is architecturally eclectic with a wide variety of styles dating from Late Victorian to contemporary. The City of Colorado Springs facilitates self-guided historic walking tours of Downtown. According to the field guide for these tours, the following styles are represented in the Mill Street neighborhood: Queen Ann (1890s), Classical Revival (1890-1920s), Late Victorian (1900s), Classic Cottage (1900s) Craftsman (1910s), and Modern (1960s). Many of the buildings in the historic inventory are in the North, whereas the historic assets in the South are not documented. Tales of the local area and many key structures, such as the Grist Mill, live on only as oral histories.

SOCIAL AMENITIES

There are a number of local gathering spots, including the Veterans of Foreign Wars, the Independence Center, Perfect Peace Baptist Church, the community garden, coffee shops, fitness studios, and barber shops. Currently there are no libraries, community centers, farmer's markets, post offices, theaters or grocery stores in the neighborhood.

DOWNTOWN DISTRICT MAP¹



HISTORIC ASSETS²

1. Wickes Lumber / ABC Supply | 1901
2. Cascade Station | 1984 (reused materials)
3. Boy's Club Building | 1907 & 1938
4. Colorado Springs Day Nursery | 1922
5. 724 S Sahwatch Ave | 1894
6. Shuga's | 1920
7. Maytag Aircraft Building | 1957
8. 720 S Tejon St | 1901-1907
9. 714 S Nevada St | 1901-1907
10. 829 S Sahwatch St | 1895
11. 817 S Tejon St | 1899
12. 810 S Nevada Ave | 1910's
13. 116 E Fountain Blvd | 1894
14. Perfect Peace Baptist Church | 1907-1909
15. 903 S Cascade Ave | 1894
16. 108 W Mill St | 1904
17. 30 W Las Vegas St | 1963
18. 23 E Las Vegas St | 1959

1. *Experience Downtown Colorado Springs*. City of Colorado Springs. https://coloradosprings.gov/sites/default/files/execsummary_sept2.pdf

2. *Map & Historic Assets assembled from Historic Downtown Colorado Springs Walking Tour*, assembled by City of Colorado Springs. <http://www.springsgov.com/plan/historic3/WalkingTour.ASP?WCI=Overview> <?> *Historic Downtown Colorado Springs*.

DOWNTOWN
COLORADO SPRINGS

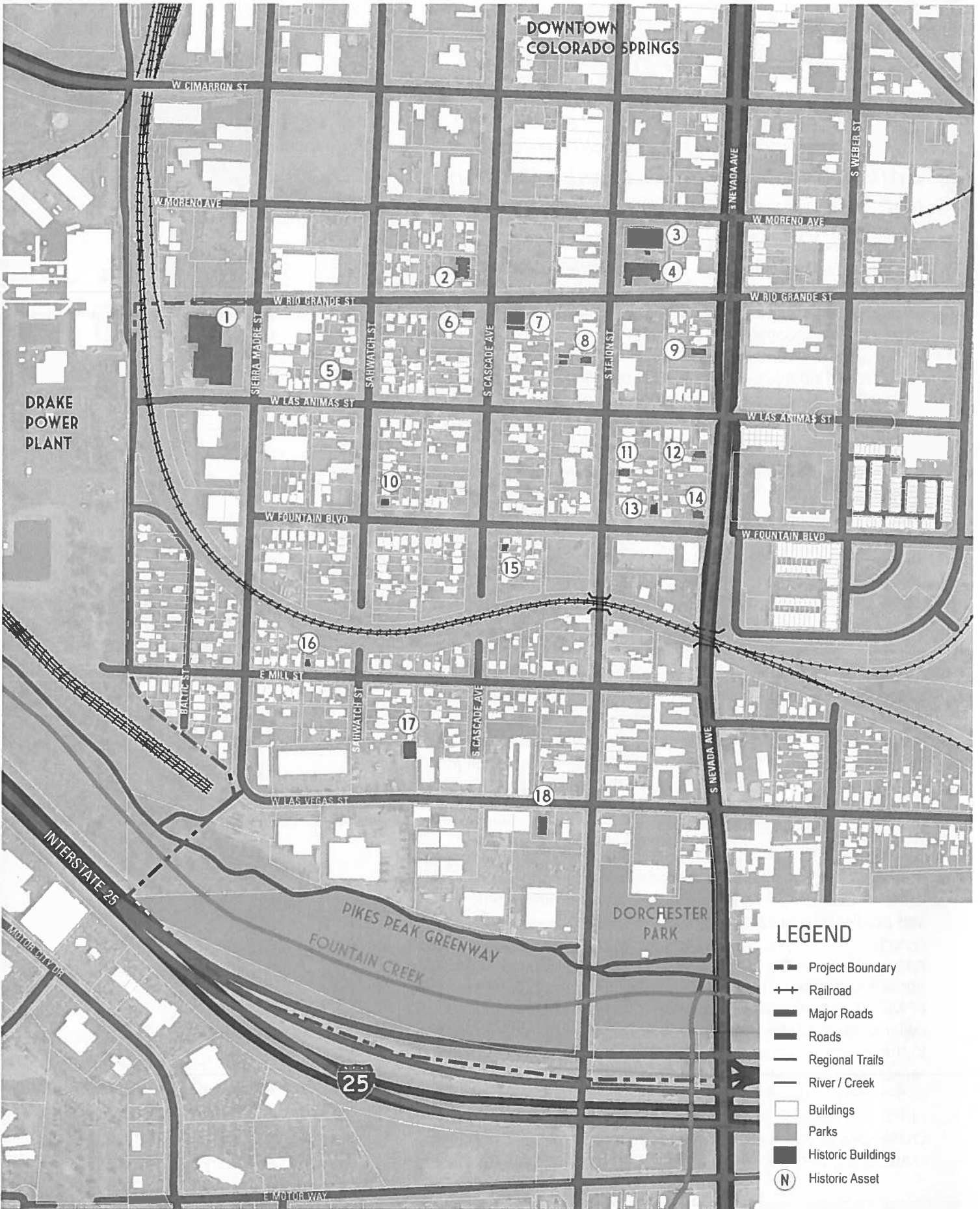

LEGEND

- Project Boundary
- Railroad
- Major Roads
- Roads
- Regional Trails
- River / Creek
- Buildings
- Parks
- Historic Buildings
- Historic Asset

**MILL STREET NEIGHBORHOOD
HISTORIC ASSETS**

250' 500' 1,000' 2,000'



LOCAL COMMUNITY

DEMOGRAPHICS

Mill Street is still—by and large—the working-class neighborhood it was one hundred years ago, though many residents are struggling to meet their basic needs.

Demographic characteristics, surrounding redevelopment projects, and rising home prices all point to this being the most vulnerable population in the city. Of the 800 residents in the area, over 60% qualify as low income. Unemployment in the area is high at 25%. Over half of residents live alone and nearly 65% rent. There are high rates of persons living with disabilities (34% versus 11% regionally), as well as diagnosed depression (27% versus 19% regionally), self-reported poor health (29% versus 14% regionally) and diabetes (13% versus to 8% nationally).¹

The majority of Mill Street residents are white (75%) and English speakers with only 1% identifying as linguistically isolated and 20.4% of Hispanic origin. Residents are largely middle-aged. There is a sizeable senior population with 15.8% of the population over the age of 65, compared with 11.3% regionally. There is a low proportion of households with children and students bus out of the neighborhood to schools.²

In addition to the residential population, the Springs Rescue Mission (SRM) and the Salvation Army are located in the neighborhood, serving people experiencing homelessness. SRM is largest homeless services facility in the county, sheltering more than 300 people per night. Their mission is to shelter and house the homeless. During its 2016 expansion, SRM, City staff, and the Mill Street Neighborhood Association drafted a Good Neighbor Agreement, acknowledging the roles that each organization played in keeping all parties informed and supported. However, the document was never signed.

Historically, Mill Street was a close-knit community and in recent outreach, many residents still report a strong sense of community pride. In 2001, the Mill Street Neighborhood Association self-published a collection of stories called, "[Once Upon a Neighborhood: Who We Are and Why We Care](#)," to share their perspectives on the Montgomery Community Center, a proposed homeless shelter. In it, Steven U. Mullens writes, "The people of Mill Street are a wonderful eclectic cross-section of blue-collar citizens of the Pikes Peak community. They have worked to their ultimate capacity to purchase, maintain and improve their residences." The stories speak of declining home values, loss of community pride and concerns about personal safety and distrust of the City. Similar stories are shared today, but also of new challenges of some rapidly increasing home prices, poor quality rental units, and few resources for maintenance and investment.

¹ Opportunity360 Measurement Report: Census Tract 23. 2017.

² U.S. Census Bureau, Census 2010 Summary File 1. Esri forecasts for 2017 and 2022.



MILL ST. MEDIAN
HOUSEHOLD INCOME

\$26,208

CITYWIDE MEDIAN
HOUSEHOLD INCOME

\$77,700



MILL ST. MEDIAN
HOME PRICE

\$158,333

CITYWIDE MEDIAN
HOME PRICE

\$273,500

ANNUAL MILL ST.
INCOME GROWTH

+1.26%

ANNUAL MILL ST. MEDIAN
HOME PRICE GROWTH

+15.4%

HOUSING & AFFORDABILITY

The Mill Street residential area is full of colorful, small-lot homes; most are single story without substantial additions or expansions.

HOUSING

Roughly 12 blocks in the neighborhood are composed of homes dating from 1902-1915. The median year of construction is 1939 and many do not meet code today. The residential community in Mill Street is about two-thirds renters. Residential vacancy rates are 19% compared to 7% regionally. The historic character of some of these homes has been restored, but also some have been converted to commercial purposes. The small size of the lots, small homes, modest designs and lack of neighborhood amenities are some of the reasons this neighborhood has not become as desirable as other historic neighborhoods in the City. High vacancy rates and low rental rates in this neighborhood are commonly attributed to the condition of units and the area, lack of services and quality community life. These smaller housing types have the potential to provide a high demand sector for a much needed price-point. Affordable housing in close proximity to downtown is a powerful tool in the economics of city-building.

AFFORDABILITY

Opportunity360, a recent report by Enterprise Community Partners, a non-profit research group, identified the Mill Street neighborhood as one of the most affordable areas in the city. Eighty-seven percent of 2-bedroom rental units in the neighborhood are affordable for median income households, compared to 63% regionally. The average rental cost per bedroom is \$645 in the neighborhood, compared to \$1,130 citywide.¹ There are new residential developments, such as the upcoming luxury 180-unit apartment building on Cascade and Moreno. At Tejon Street and Cimarron Street, a 27-unit, four-story apartment building is under construction, which will offer luxury lofts that will rent for \$1,200 for studios and up to \$2,000 for two-bedroom units. Protecting the historic affordability of the area was a stated goal of the Mill Street Neighborhood Preservation Plan. Data from the Environmental Systems Research Institute (ESRI), US Census Bureau, and American Community Survey (ACS) estimate the 2017 median home value in the neighborhood at \$158,333, which they predict to grow to \$280,263 by 2022. This includes an annual growth rate of 15.4%, grossly out of step with the estimated 1.26% annual income gains. The cost per square foot in Mill Street is \$133, comparatively affordable to the citywide average of \$176 per square foot.

¹ Laden, Rich. "Apartment rents up again in Colorado Springs, but remain shy of record highs." *Colorado Springs Gazette*. April 30, 2018.



TOP TO BOTTOM:
RESIDENTIAL HOME
CORNER OF MILL & SIERRA MADRE

Only 5% of community survey respondents indicated "quality of life" is what they like most about the Mill Street neighborhood.

(SOURCE: COMMUNITY SURVEY, 78 RESPONDENTS)

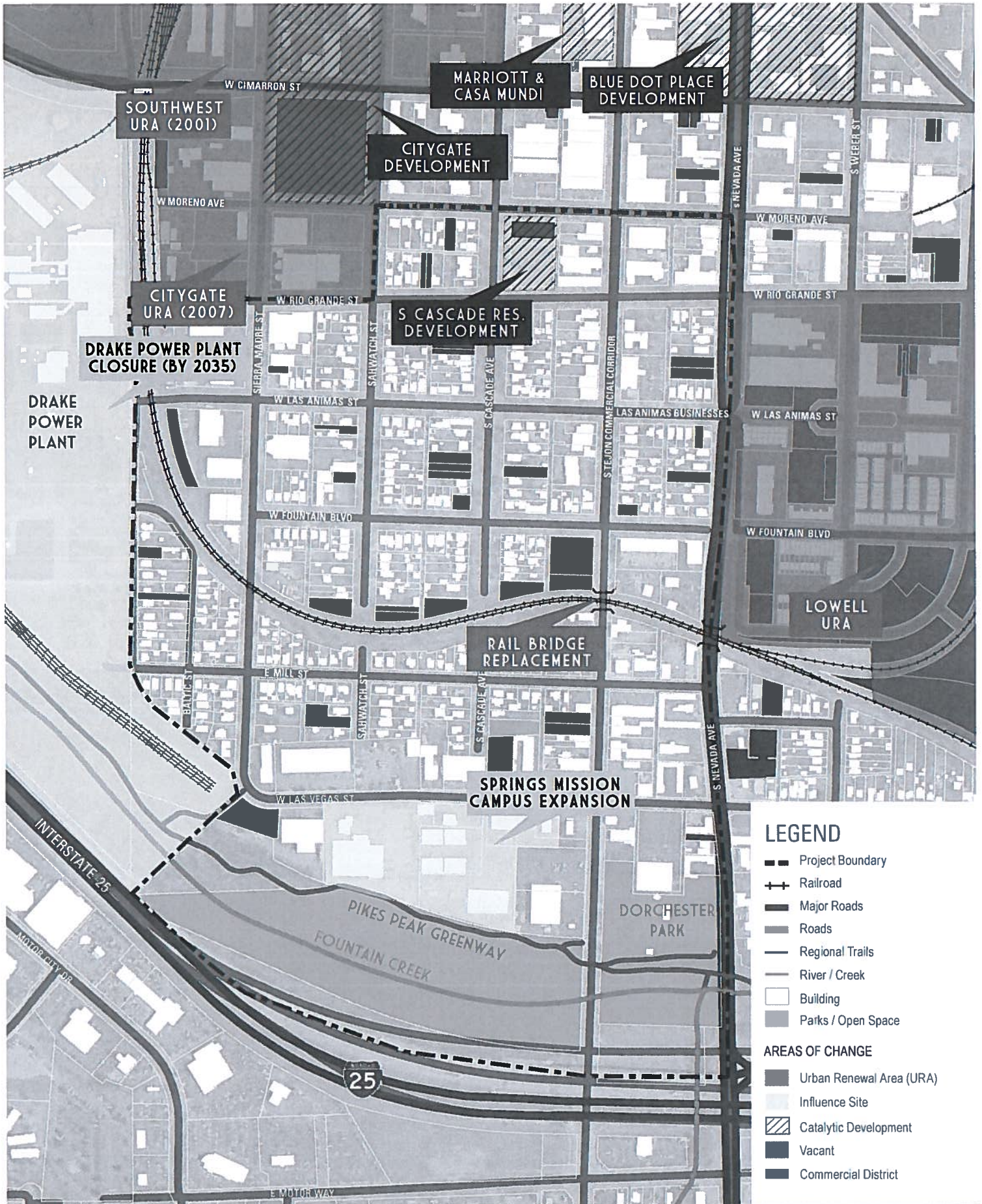

LEGEND

- Project Boundary
 - Railroad
 - Major Roads
 - Roads
 - Regional Trails
 - River / Creek
 - Building
 - Parks / Open Space
- AREAS OF CHANGE**
- Urban Renewal Area (URA)
 - Influence Site
 - Catalytic Development
 - Vacant
 - Commercial District

**MILL STREET NEIGHBORHOOD
AREAS OF CHANGE**



LOCAL COMMUNITY



ECONOMICS

There are 148 businesses located in the Mill Street neighborhood.

LOCAL BUSINESS

Of these businesses, 51.4% are in the services sector, 20.9% in professional services, 13.5% in retail, 10.1% in finance, and 6.1% in wholesale trade. A study of 2017 consumer spending in the area, compiled by ESRI, shows that the top three categories for spending were "Food at Home," "Shelter," and "Entertainment." Along the southern and western edge is an active industrial area, including supply, automotive and storage companies. There are a number of area service providers, including Salvation Army, the Independence Center and the Springs Rescue Mission.

Retail is mostly centered along Tejon and Nevada streets. In recent years, Mill Street has undergone a commercial revitalization. The upcoming U.S. Olympic Museum and soccer stadium northeast of the neighborhood is expected to be the biggest catalyst for further redevelopment. Along South

Tejon Street, a full-service restaurant, Coquette's, opened in 2017 and Gold Camp Brewing Company opened in 2015. The food and retail redevelopment on the northwest corner of South Tejon and Moreno is opening in late summer 2018. Local developers have been active in the area for decades, retrofitting a number of historic bungalows into office spaces along Las Animas Street between Tejon Street and Nevada Avenue.

OPPORTUNITY ZONE

As part of the 2017 tax reform package (Tax Cuts & Jobs Act), the Federal government enacted Opportunity Zones to support areas where economic recovery was uneven and a "persistent lack of growth...left many communities across the country behind." The Opportunity Zone program offers federal tax incentives to investors that invest in designated low-income areas. The Mill Street neighborhood is entirely located within Census Tract 2300, one of the tracts selected statewide for designation as an Opportunity Zone. For more information on Opportunity Zones, visit [the Choose Colorado website](#).

LOCAL COMMUNITY

LOCAL CHALLENGES

ENVIRONMENTAL CONCERNS

With its early industrial heritage, the Mill Street neighborhood is unique to any other area in Colorado Springs in that it borders Interstate 25, the railroad tracks, and the Martin Drake power plant. While the pollutants from all of these sources individually meet EPA standards, the combined impact on air quality in the Mill Street neighborhood is a concern for some of the residents. Motor vehicles are the primary pollution source in the Pikes Peak region, emitting more than 80% of carbon dioxide and over half of nitrogen oxide. Motor vehicles, along with construction activities, account for most particulate matter pollution. Coal-fired power plants are the main source of sulfur dioxide emissions. Emissions from Drake are well below EPA requirements and ambient monitoring of the plant's impact is ongoing. All of the Pikes Peak region complies with federal air quality standards. (Colorado Department of Public Health & Environment, Report to the Public 2017-2018).

COMMUNITY SAFETY

Many residents and business owners report both the rising crime and slow response time from law enforcement as the leading factors impeding quality of life in the neighborhood. Arrest data, calls for service, and police response times by and large match the neighborhood perception. In the community survey, reduced crime was the top response (50% of respondents) to the question 'what do you think are the most important outcomes for a successful neighborhood plan?' The survey also featured a write-in portion to describe the neighborhood today in one word. 49% of responses were negative (16% neutral and 35% positive) with 'homeless' and 'run-down' as the top responses but also 'dangerous', 'challenged,' 'forgotten' and 'troubled' as other responses. From 2013 to 2017,

arrests for non-violent crime in the Mill Street area increased by 44%, while they decreased by 6% citywide. Local violent crime arrests nearly tripled, compared to a 21% rise citywide. The neighborhood sits between two police stations, the Rio Grande Operations Center and the Gold Hill Division. 2018 response time data shows that while the Colorado Springs Police Department has improved response times to Priority 1 calls, the most urgent, it has also reported slower response times to Priority 2 and 3 calls citywide than previous years.

PUBLIC SPACE SAFETY

The neighborhood's only park, Dorchester Park, is widely seen as unusable due to rampant criminal activity. When compared to other urban parks in the City, Acacia Park in the downtown core and Bancroft Park in Old Colorado City, Dorchester Park receives hundreds more calls for service as logged by CSPD. Between 2014 and 2017, calls for service at Dorchester more than doubled, while decreasing (-53%) at Bancroft and marginally increasing (7%) at Acacia. Similarly, survey respondents found the trail along Fountain Creek risky and unpleasant due to trash, debris, and illegal encampments. CSPD reports an average of 11 arrests per month along and adjacent to the trail for liquor law violations, nearly eight per month for trespassing, seven per month for other offenses including public urination/defecation, harassment, smoking, among others, and four per month for drug use. This kind of behavior discourages use of the trail, creates adverse conditions, and also makes people experiencing homelessness more vulnerable to violent crime.

SERVICE CALLS PER PARK COMPARISON

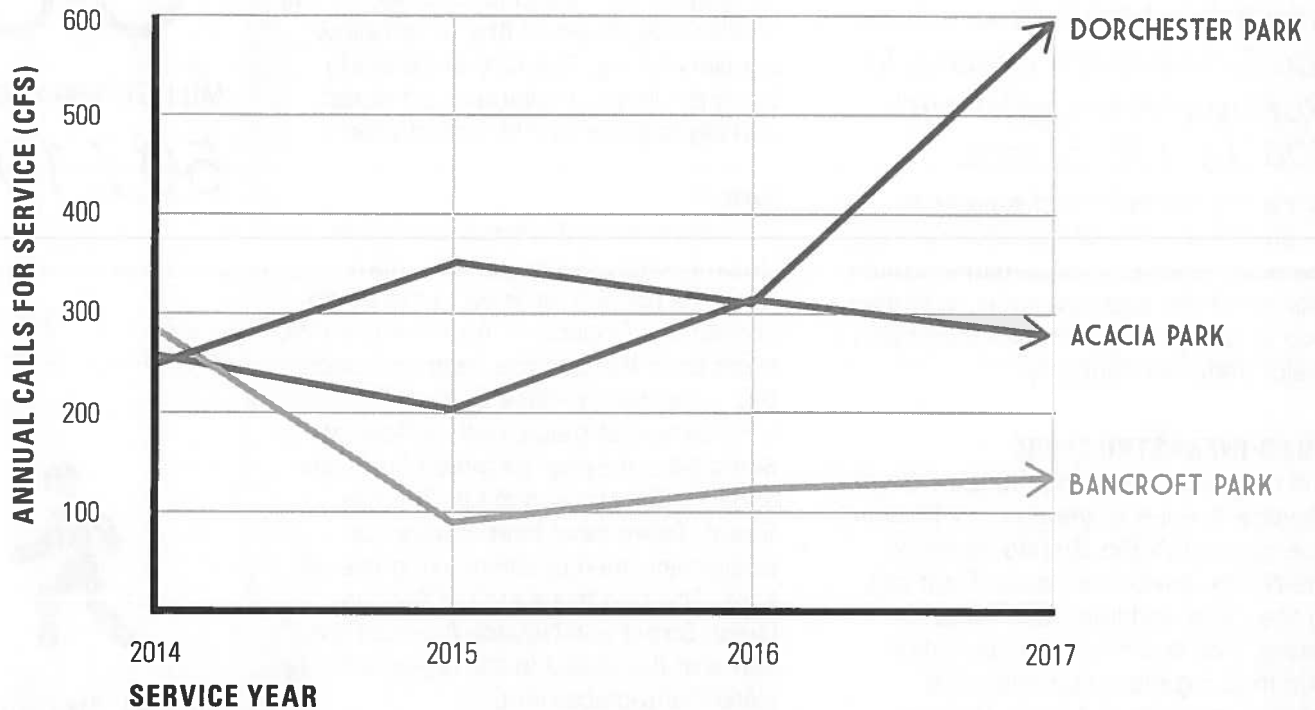

SERVICE YEAR
 (SOURCE: COLORADO SPRINGS POLICE DEPARTMENT,
 STRATEGIC INFORMATION CENTER, 2018)

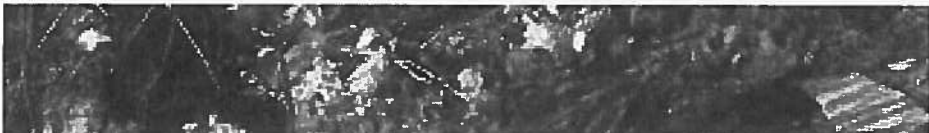
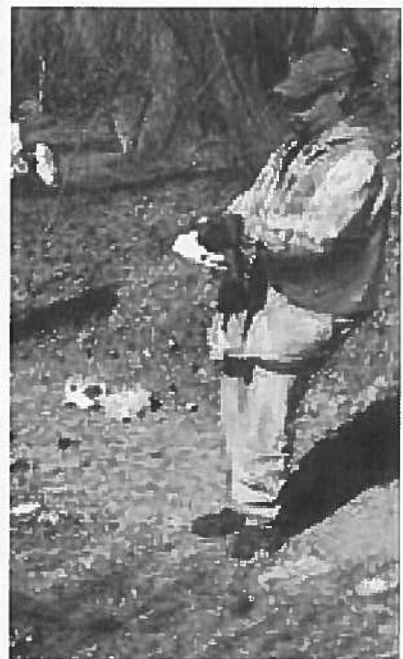

**TRASH CLEAN UP ALONG
 FOUNTAIN CREEK**
 CREDIT: KRDO

TRANSPORTATION & MOBILITY

The Mill Street neighborhood maintains the Downtown Colorado Springs street grid with 400' by 400' blocks.

While the neighborhood is centrally located in the City of Colorado Springs, there are several physical barriers that isolate it from adjacent areas, including two local highways, railroad tracks and a major interstate highway.

ROAD INFRASTRUCTURE

The neighborhood is bounded by South Nevada Avenue to the East, W Moreno Avenue and W Rio Grande Street to the North, the Drake Power Plant site to the West and Interstate 25 to the South. I-25 is a major transportation and trucking route that connects Wyoming to New Mexico. There is north/south access to I-25 from the Mill Street neighborhood at three locations: Cimarron Street, South Tejon Street and South Nevada Avenue. The City of Colorado Springs has designated Highway 24, Highway 87 and I-25 as truck routes. Las Vegas Street is used locally as a truck route. Within the neighborhood, there are over four miles of on-street bike lanes, providing good north/south and east/west connectivity. There are two connections to the Pikes Peak Greenway.

PARKING

Parking is available throughout the neighborhood. On-street parking meters are patrolled on Tejon Street from Cimarron Street to Rio Grande Street and on Rio Grande between Nevada and Cascade, Monday through Saturday 8:00 a.m. – 6:00 p.m. Local streets have few parking restrictions and parking is available on both sides of the streets for the public. The County-operated Tejon Street parking garage is also available to the public on a limited basis. Businesses reported insufficient

parking and rely mostly on close street parking for their patrons, afforded by the area's wide street widths which allow parallel parking. The City of Colorado Springs follows a minimum off-street parking requirement for specific uses.

RAIL

The neighborhood is bisected by the Union Pacific / Burlington Northern Santa Fe (BNSF) rail lines to the south of Fountain Boulevard. Approximately 50 trains pass through the neighborhood a day, a noticeable noise impact. The rail line has two at-grade intersections at Sierra Madre Street between Fountain and Mill Streets, and at Las Animas Street. There have been numerous pedestrian/train conflicts along the rail lines. The two overpass rail bridges (Tejon Street and Nevada Avenue) are some of the oldest in the region and are slated for replacement.

BUS TRANSIT

Residents and visitors to Mill Street have access along South Nevada Street to three municipal bus lines (10, 11 & 15) through Mountain Metropolitan Transit.

PEDESTRIAN REALM

Streets are characteristic of General Palmer's generous street allowance in the original platting of the city, with an average right-of-way of 100' for local streets, including tree lawns and detached sidewalks. In initial analysis, of the 11 miles of sidewalk, 29% were incomplete or unpaved. Empty tree lawns are a common sight in the neighborhood. South Cascade Avenue is a local boulevard street, 140' in width, with a prominent central median and mature canopy. Though the sidewalks on South Cascade are in good repair and have ADA complaint crosswalks, street tree replacement is needed to restore the character of the boulevard to match the northern portion. Pedestrian lighting, particularly in the southern portion of the neighborhood, is lacking.



MILL ST. WALKSCORE

50 / 100

CITYWIDE WALKSCORE

36 / 100



MILL ST. BIKESCORE

71 / 100

CITYWIDE BIKESCORE

46 / 100



MILL ST. MOBILITYSCORE

37 / 100

CITYWIDE MOBILITYSCORE

19 / 100

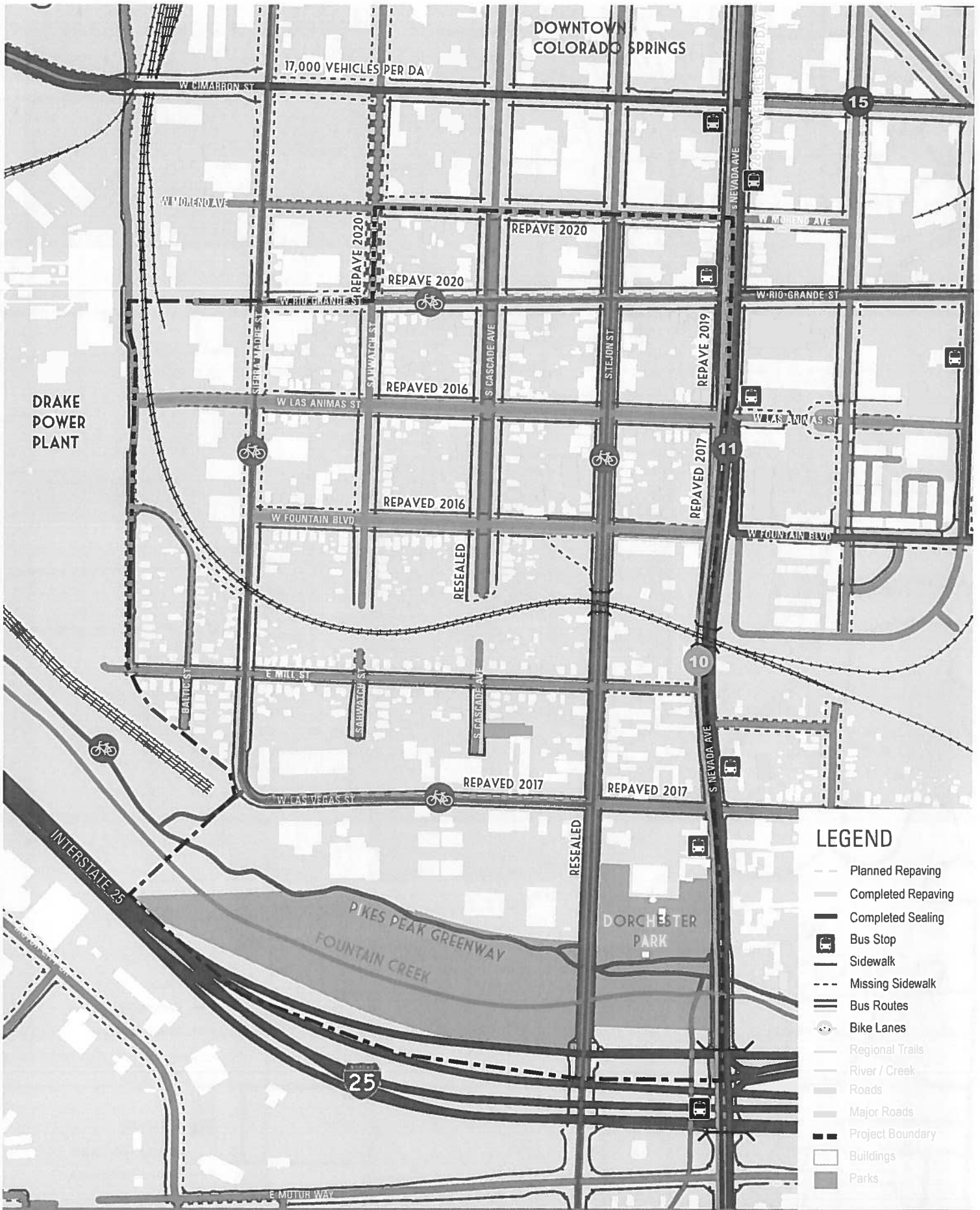

DOWNTOWN
COLORADO SPRINGS

17,000 VEHICLES PER DAY

26,000 VEHICLES PER DAY

15

DRAKE
POWER
PLANT

REPAVE 2020

REPAVE 2020

REPAVE 2020

REPAVED 2016

REPAVE 2019

REPAVED 2016

REPAVED 2017

RESEALED

REPAVED 2017

REPAVED 2017

RESEALED

PIKES PEAK GREENWAY
FOUNTAIN CREEK

DORCHESTER
PARK

LEGEND

- Planned Repaving
- Completed Repaving
- Completed Sealing
- Ⓡ Bus Stop
- Sidewalk
- - - Missing Sidewalk
- Bus Routes
- Ⓡ Bike Lanes
- Regional Trails
- River / Creek
- Roads
- Major Roads
- - - Project Boundary
- Buildings
- Parks

**MILL STREET NEIGHBORHOOD
TRANSPORTATION + MOBILITY**

250' 500' 1,000' 2,000'



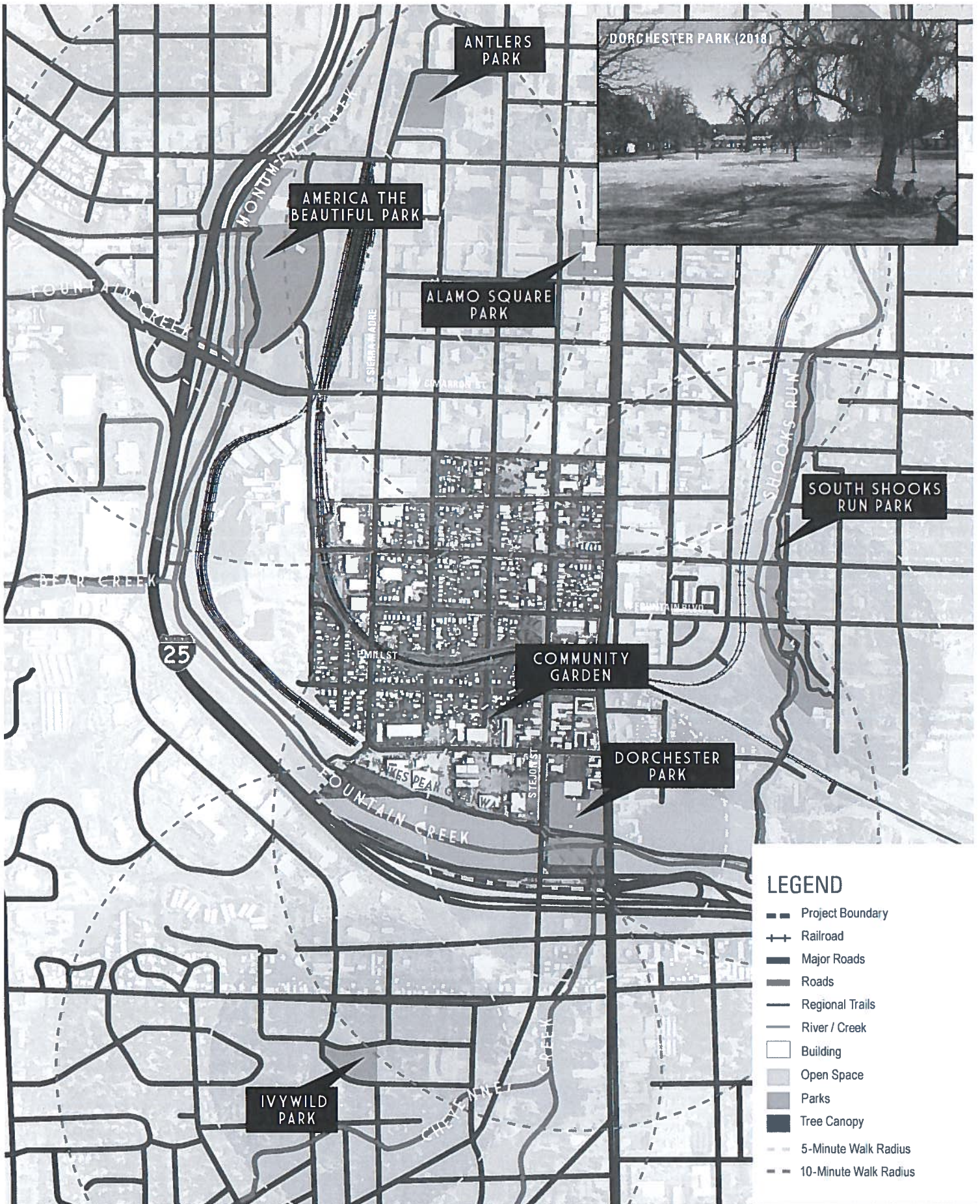

LEGEND

- Project Boundary
- Railroad
- Major Roads
- Roads
- Regional Trails
- River / Creek
- Building
- Open Space
- Parks
- Tree Canopy
- 5-Minute Walk Radius
- 10-Minute Walk Radius

PARKS & OPEN SPACE

The Mill Street Neighborhood is located southeast of the confluence of Fountain and Monument Creeks, the location where Colorado Springs was founded.

Fountain Creek comprises the western and southern edges of the area and native cottonwood groves fringe much of the neighborhood. The Pikes Peak Greenway runs along the edge of the Tejon Wetlands. This Greenway connects to the Shooks Run trail. Due to the fragile nature of the wetlands and wildlife habitat, it is encouraged to stay on the trail. The two trail facilities make up a significant portion of the planned 10-mile Legacy Loop Trail—a park and recreation loop around Downtown. Within a 10 to 20 minute walk from the neighborhood are two prominent parks: America the Beautiful Park and Alamo Square Park, the site of the Colorado Springs Pioneers Museum. There is also a local community garden at S. Cascade Avenue and Mill Street.

PARKS

Dorchester Park is the only public park in the study area and is located at the far south-east corner of the neighborhood. It is one of the oldest parks in Colorado Springs, established in 1893. The park has multiple deeds and was donated in part by the Dorr family in 1890, who named it Dorchester Park. Situated on Fountain Creek, the park was historically susceptible to flooding; a large flood in 1935 destroyed all structures on the site outside of the stone picnic structure that still exists today. Today, the park is categorized as a neighborhood park of 7.4 acres and has a picnic shelter and a playground. It has not been heavily utilized by neighborhood residents for decades mostly due to its non-central location,

condition, and safety considerations. The park is heavily used by people experiencing homelessness. It is a site for illicit activities and emergency meal services (not authorized by the City) ceased operation in 2017 due to public outcry of 'enabling' and safety concerns on the part of volunteers. In 2017, the Parks, Recreation and Cultural Services Department spent between 350 and 400 man hours of labor cleaning up the park. The vast majority of other neighborhood parks receive an average of less than 90 hours of labor over the course of a year. With its current uses, the park does not serve the community well. Public meeting attendees expressed the need for a convenient public space where they feel safe.

OPEN SPACE

To the south of Dorchester Park is the 11.8 acre Tejon Wetlands along Fountain Creek, north of I-25. The open space is a riparian floodplain with native wetlands and cottonwood stands with no public access. There are "no camping" ordinances in effect that apply to park land and also to the floodplain in this location. The southern edge of Fountain Creek is armored with a concrete wall, whereas the northern edge is naturalized. The Pikes Peak Greenway runs through the site and there are two spur connections to the trail from bike lanes on Sierra Madre and Tejon streets.

URBAN FOREST

Tree canopy covers 8% of the landmass in the Mill Street neighborhood, with most mature trees situated along the creek bed, in Dorchester Park, along South Cascade Boulevard and in private yards. Mill Street's historic residential streets maintain broad rights-of-way (ROW) with sizable tree lawns. Today, many of those ROWs are missing trees at regular intervals. According to PRCS staff, this is the result of increases in water prices, age of the trees and drought conditions.

E. CIMARRON

CIMARRON

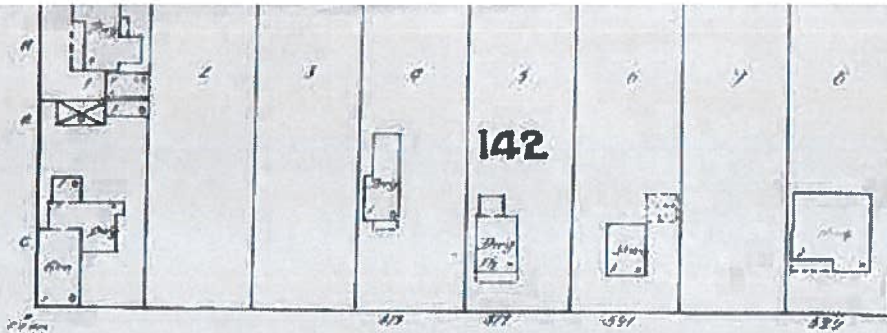

142

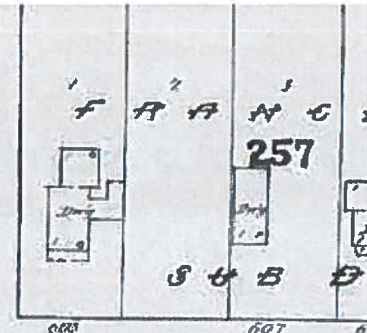

F R A N C

257

S U B D

S. TEJON

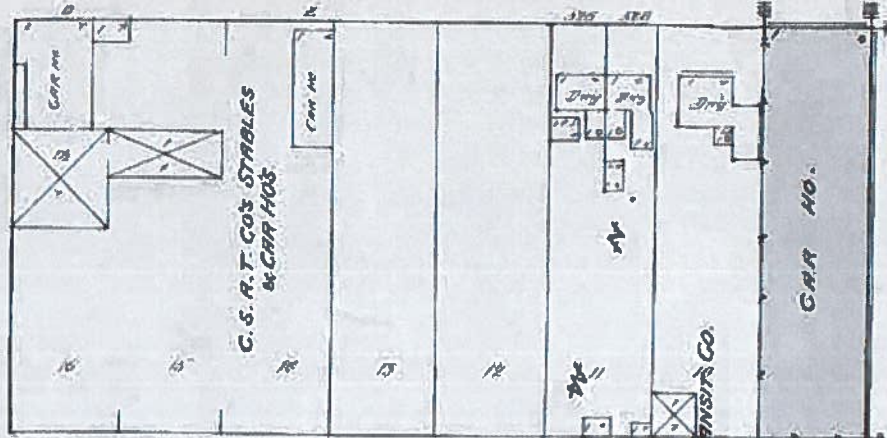

141

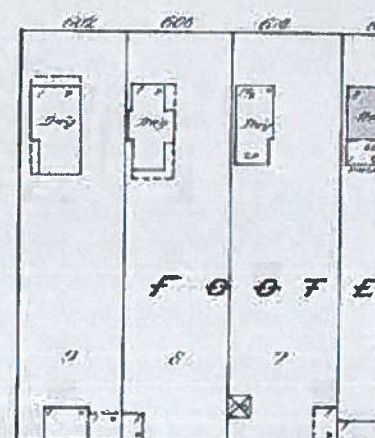

F O O T E

258

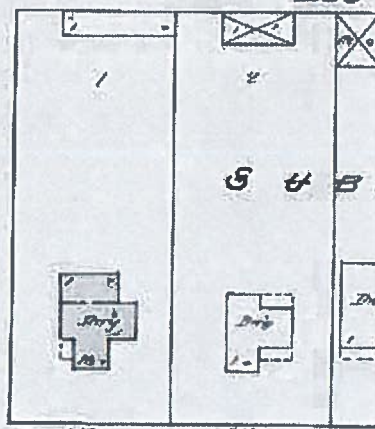
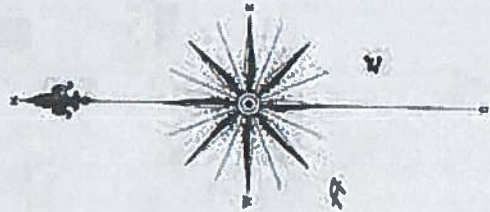
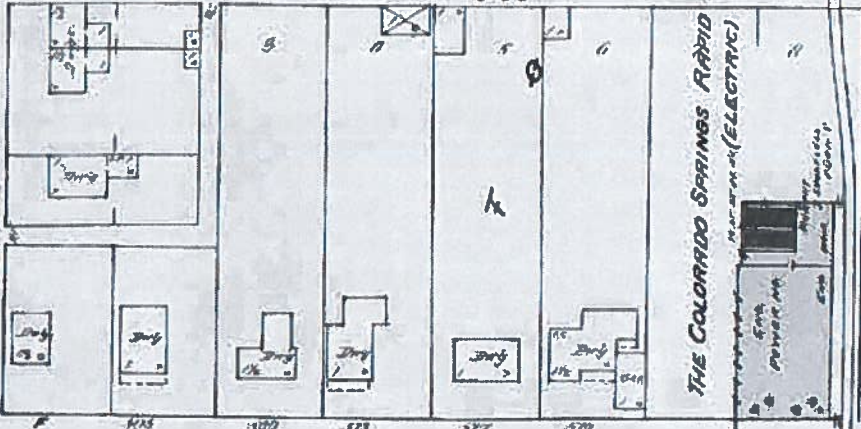

S U B

S. CASCADE AV

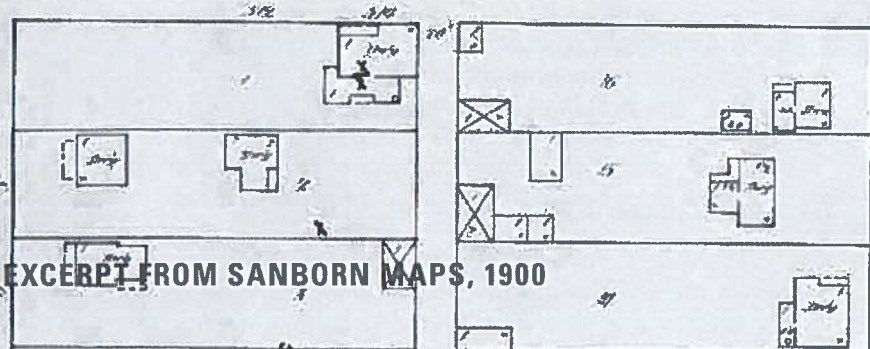

EXCERPT FROM SANBORN MAPS, 1900

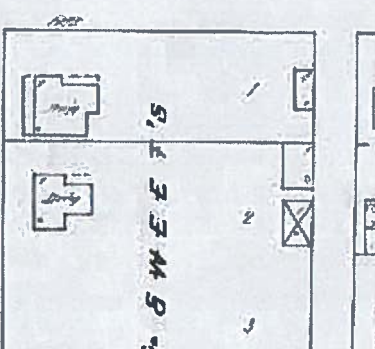

E. MORENO

PLAN CONCEPTS & RECOMMENDATIONS

Goals

Enhance Quality of Life for Mill Street Residents

Cultivate Mill Street Character

Reconnect Mill Street People & Places

Create a Resilient Future for Mill Street



VISION

The Mill Street Neighborhood will be a thriving, dynamic place that celebrates its diversity and history.

A neighborhood vision helps answer the question "How does the community see itself in the future?" and captures this aspiration in a single statement. The neighborhood vision was developed at the Strategic Kick-off meeting and was informed by community input throughout the planning process.

GOALS

To achieve this vision, community input has directed four major goals for the Mill Street Neighborhood.

Each goal provides the framework for specific strategies and tactics to help the City of Colorado Springs and the Mill Street Neighborhood work in tandem to achieve the plan vision.

1. ENHANCE THE QUALITY OF LIFE FOR MILL STREET RESIDENTS

Community members in the study area experience many of the great qualities of their environment, including beautiful views to the mountains, great proximity to Downtown Colorado Springs and, currently, affordable housing in a competitive market on Colorado's Front Range. However, there are several factors residents identified, such as trash, unsafe streets and trails, that negatively impact their quality of life.

2. CULTIVATE MILL STREET CHARACTER

Mill Street has a variety of defining characteristics, such as its historic homes, wide boulevards and proximity to one of the area's natural assets, Fountain Creek. When residents, business owners and area workers were asked in a community survey about the Mill Street Neighborhood, many were surprised to learn that the area had a name. This lack of recognition creates unstable boundaries for the neighborhood and does a disservice to the area's identity within the City.

3. RECONNECT MILL STREET PEOPLE & PLACES

Mill Street has some great regional connections for multiple types of transportation, such as its immediate vehicular access to I-25, pedestrian and bike links to the Pikes Peak Greenway and Legacy Loop and being within walking distance to Downtown Colorado Springs. Engagement with neighborhood community members indicated that while regional connections may be great, the neighborhood's internal connections, both physical and social are lacking. The goals are to encourage more accessible infrastructure and facilitate better communication and inclusive development.

4. CREATE A RESILIENT FUTURE FOR MILL STREET

Today the Mill Street Neighborhood is facing big challenges like rising rents, encroaching downtown development and evolving demographics. As the neighborhood looks toward the future, building strength in the local business community, protecting housing affordability and promoting neighborhood ownership will fortify the area and help residents respond, adapt and thrive as the City evolves.

In a fiscal impact assessment by the Budget Office, the income stream from increased residential population, development and construction fees, and increased commercial activity for 2019-2028 outweighs the costs of implementing this plan and is a net positive gain for the City.



GOAL 1:

Enhance the Quality of Life for Mill Street Residents

With a lack of basic amenities in the neighborhood and safety concerns, elevating the quality of life for residents is a top priority.

Community members experience many of the great qualities of their environment, including beautiful views to the mountains, great proximity to Downtown Colorado Springs and currently, affordable housing in a competitive market on Colorado's Front Range. However, there are several factors residents identified that negatively impact liveability.

SAFETY Instances of criminal activity, lack of infrastructure and transportation problems all contribute to real and perceived issues of safety in the neighborhood. In order to achieve the neighborhood vision, restoring residents' sense of safety in the community will be imperative.

ENVIRONMENT The prevalence of trash in the neighborhood, noise from the railroad and I-25, and the degradation of outdoor amenities, such as the adjacent Fountain Creek trail, create adverse conditions that concern some residents. Improving conditions in the area will benefit Mill Street residents' quality of life.

SOCIAL INTERACTION One of the defining elements of quality environments are opportunities for social interaction. Interactions can be casual, such as saying hello to a neighbor, or more organized, such as a neighborhood block party. While Mill Street does offer some opportunities for connection, such as annual celebrations, the area lacks accessible and comfortable spaces for these to occur. Identifying opportunities and spaces for social connection will help Mill Street achieve its vision.

Improve Community Safety

1. Enhance the **relationship between area service providers and residents** by providing platforms for cross-communication between entities like the Salvation Army and Springs Rescue Mission and Mill Street residents. Platform examples include a neighborhood website, the NextDoor app, mailings or a dedicated liaison.

have positive impacts on quality of life by artificially extending light hours that allows for activity to take place. Street lighting also improves safety for drivers, bus riders, bicyclists and pedestrians.
2. Revisit a **Good Neighborhood Agreement** or other good faith effort of collaboration with area service providers (such as Salvation Army and Springs Rescue Mission), Mill Street Neighborhood Association and City of Colorado Springs Planning and Community Development.
3. Foster **stronger relationships between community members and with police officers** by establishing a CSPD community liaison, organizing a Crime Prevention through Environmental Design training for residents and business owners and encouraging interaction between neighbors to build community cohesion and an improved sense of safety.
4. Support the development of a **street outreach program** to connect homeless community members with available service providers.
5. Increase **street lighting** in the Mill Street Neighborhood. Street lighting will help promote security and can
6. Improve **accessibility** and ADA compliance along sidewalks and at intersections throughout the neighborhood to support area residents with disabilities, families with strollers and cyclists.
7. Activate and beautify spaces under **rail bridges** on Tejon Street and Nevada Avenue corridors to detract vandalism, remove debris, and provide a gateway identity to the Mill Street Neighborhood.

Resident concerns for safety are supported by local police data. The neighborhood has seen significant increases in both non-violent and violent crimes between 2013-2017. There is no proven correlation between increased homelessness and increased crime.

Improve Environmental Quality

8. Develop a voluntary **urban street tree** planting and maintenance program with City Forestry for the neighborhood to increase urban canopy, improve environmental quality and aid in area beautification, similar to the North End Woodlands Tree Planting program.
9. Work with City Forestry team to monitor, preserve and provide maintenance assistance for **mature trees** within the Mill Street neighborhood.
10. Monitor **rail compliance** with federal noise level standards. Work with the Federal Railroad Administration and the Environmental Protection Agency to measure noise levels and recommend any necessary changes to protect the noise environment for local residents and advocate for the health and welfare of Mill Street residents in upcoming rail corridor study.
11. Work with the El Paso County Air Quality Program to monitor and continue improving **air quality conditions** in the Mill Street neighborhood in accordance with EPA standards. Residents' proximity to the interstate, Drake Power Plant, and rail lines expose the community to a variety of air pollutants. El Paso County is committed to protecting public health and the natural environment through its Air Quality program. This program actively responds to air quality complaints.
12. Incorporate the Mill Street neighborhood into future **stormwater** capital improvements. As the City continues to investigate and plan for a "Watershed Wise" approach to managing its stormwater, the Mill Street neighborhood should be considered for future pilot programs and capital improvements. The neighborhood's wide rights-of-way and proximity to Fountain Creek make the area a great location for green infrastructure improvements that could offer multiple benefits to the community.
13. Advocate for **moving power lines underground** in future Colorado Springs Utilities planning efforts to improve aesthetics and safety in the neighborhood.

CASE STUDY: URBAN POWER PLANT DECOMMISSIONING

According to the 2017 report [Decommissioning US Power Plants](#), the net cost of decommissioning a coal power plant ranges from \$30m to \$85m. The Seaholm plant in Austin, Texas offers a promising example of life after decommissioning. After 22 years of transition, the 8-acre inner city site is being reimaged as a mixed use complex. The 1950's art deco shell of the plant was preserved by a grassroots movement and is being incorporated as a landmark retail / residential development. The project opened in 2017 and won a ULI Global Award of Excellence.



Increase Opportunities for Social Engagement

14. Explore opportunities for a new **community gathering space** in the neighborhood. This neighborhood currently does not have any public or civic facilities to meet, gather or commune. Community members have expressed interest in a community center and/or an outdoor public space to foster social engagement. Other gathering spaces could be provided through smaller interventions such as seating or benches along rights-of-way or community-developed parklets that take advantage of currently vacant or under used spaces. Possible avenues to address lack of community space are stronger connections and service to the Hillside Community Center and activation of Dorchester Park.
15. Provide institutional support for and promotion of **community events** generated by Mill Street community members through CONO.
16. Pursue grant funding to create a **restorative garden** at the Springs Rescue Mission campus to offer individuals who access neighborhood service providers a safe, comfortable and visible space to spend time when access to shelter options are not available. Space design should consider the inclusion of therapeutic gardens, urban agriculture and other productive landscape design.
17. Incentivize **private commercial uses** to include gathering spaces. Outdoor dining and indoor gathering spaces associated with businesses should be encouraged.
18. Plug into existing programs and events that foster community while **beautifying the city**. Ex: City Department of Public Works' Adopt-a-Waterway, Creek Week, Trash Mob (cleanups while in themed costumes), What If Festival, etc.
19. Partner with Pikes Peak Library District and the Pioneers Museum to explore Mill Street **pop-up programming**, such as oral history walking tours and pop-up libraries.
20. Explore commercial viability and permitting for **food truck** nights in Mill Street.

DENVER STREET OUTREACH COLLABORATIVE (DSOC)

DSOC is a joint effort between public & nonprofit partners. Run by the Colorado Coalition for the Homeless, City and County of Denver, St. Francis Center and Urban Peak, the program builds trust between homeless community members and service providers and helps individuals gain access to services. The goal of the street outreach program is to "address immediate needs of safety, provide crisis intervention, and ultimately to connect people to housing, medical and mental health care, public benefits, clothing, food, and other supports." The program provided services to homeless individuals through over 30,000 contacts and assisted 274 people in obtaining permanent housing in 2015.



GOAL 2:

Cultivate Mill Street Character

Mill Street has a variety of defining characteristics, such as its historic homes, wide avenues and streets and proximity to one of the area's natural assets, Fountain Creek.

When residents, business owners and area workers were asked in a community survey about the Mill Street Neighborhood, many were surprised to learn that the area had a name. This lack of recognition creates unstable boundaries for the neighborhood and does a disservice to the area's identity within the City.

NEIGHBORHOOD HISTORY Past and present residents of the Mill Street neighborhood have gone to great lengths to collect stories about the area's evolution and document their own histories. Reinforcing these stories and protecting the unique character of the community will help to define the neighborhood and build strength around its identity.

SENSE OF PLACE Residents have identified many of the neighborhood's historic structures and local businesses as important community landmarks, but these assets lack a unifying feature to tie the pieces together. Creating local programs and building a family of aesthetic characteristics for the neighborhood will help create that sense of place the area needs to celebrate its identity.

PHYSICAL ATTRIBUTES As cities along the Front Range continue to grow and change, some area residents have found that the "new and shiny" often replaces the "old and tired." In Mill Street, community members cherish the unique and historic elements of their neighborhood. Polishing and restoring some of these features will help the neighborhood maintain its treasured character while still providing opportunities to balance old with new.

Showcase Mill Street's History

21. Support the preservation and restoration of historic buildings and neighborhood character. Study the potential **historic district designation** of Mill Street and engage residents to weigh the benefits and shortfalls.
22. Showcase neighborhood history through **public exhibits** and expand the Downtown Colorado Spring's Historic Walking Tour to include key sites and structures in the Mill Street Neighborhood.
23. Design and implement an **educational signage** and wayfinding program in the Mill Street neighborhood that highlights personal stories and historically significant sites such as Fountain Creek, the site of the Old Mill and Cascade Boulevard.

Reinforce Mill Street's Sense of Place

24. Adopt 'Mill Street' as the **name** of the study area and work with area residents and local businesses to develop clear messaging about the Mill Street identity and brand. Integrate the concepts from Imagine Downtown character zones in areas where the boundaries overlap.
25. Encourage and support **restoration** of historic buildings and landscape through design guidance documents, resource guides and funding.

What name do you think identifies the neighborhood?

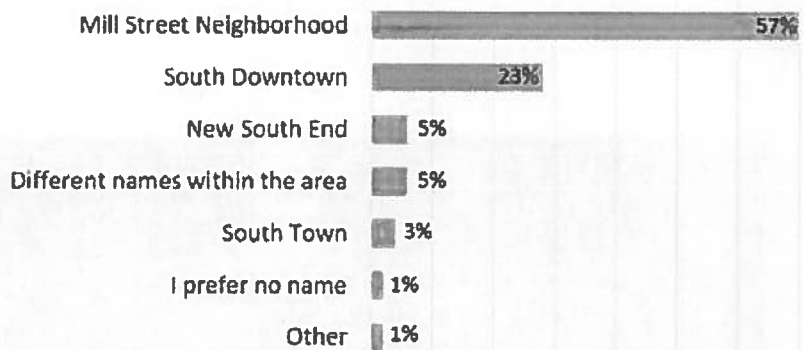

(SOURCE: PUBLIC MEETING POLLING, 70 RESPONDENTS)

CASE STUDY: NATIONAL REGISTER HISTORIC DISTRICTS

Colorado Springs has three designated historic districts: Old North End, North Weber-North Wahsatch Ave and Boulder Crescent. The City is currently reviewing the 1993 [Historic Preservation Plan](#) with an eye towards increasing registered districts. Designation requires the mean building age to exceed 50 years and a degree of architectural uniformity. While National Register districts tend to preserve historically wealthy parts of town, New Orleans has a number of designated working class neighborhoods, including Holy Cross, Friscoville and Old Arabi, that provide a precedent for Mill Street.

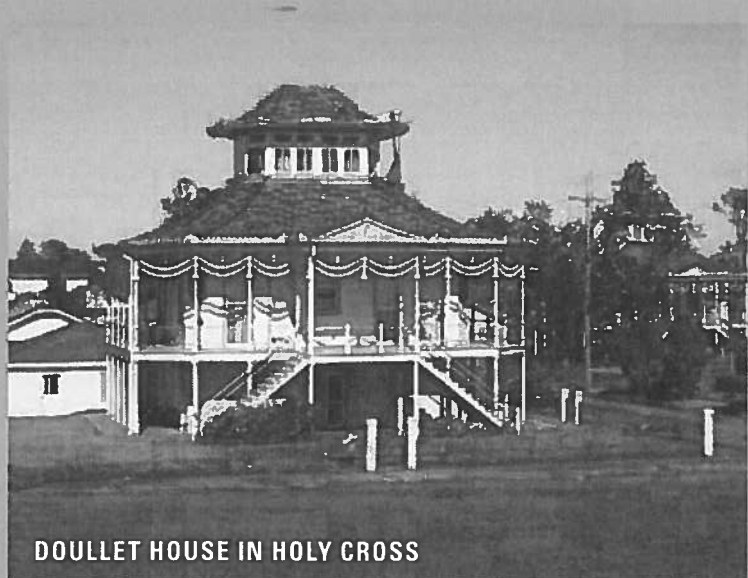

DOULET HOUSE IN HOLY CROSS

Highlighting Mill Street's Key Physical Attributes

26. Explore preservation models for **small homes**. As housing needs in Colorado Springs increase, the City should explore options for increasing density while maintaining the scale of housing currently found in the community.
27. Restore the character of **South Cascade Avenue**. Current tree canopy, planting and maintenance of Cascade should reflect the historic character of this important boulevard and maintain consistency with the boulevard's treatment in residential neighborhoods to the north.
28. Explore opportunities for re-envisioning the rights-of-way along the neighborhood's historic **wide avenues and streets**. This alternative public space could foster new and creative ways to bring residents out into social spaces, celebrate community, calm traffic and incorporate arts and education into neighborhood.
29. Showcase the character of the neighborhood on **city infrastructure** (such as murals and reference to historic stonework on bridges and along streets).



CASE STUDIES: PRESERVING SCALE & HISTORIC HOMES

Small Home Rehabilitation

The New York Department of Housing Preservation and Development and the New York City Housing Authority partners with nonprofits to run the Small Homes Rehabilitation Program. Through the program, vacant residential properties are rehabilitated to offer home ownership opportunities to low to moderate-income homebuyers. So far the program has assisted 100 New York families in pursuing their dream of owning a home.



Maximum Lot Coverage

Arlington, VA (along with many jurisdictions) sets maximum lot coverages to preserve scale. They provide incentive "bonuses" as a means to encourage attractive features, such as front porches and detached garages.

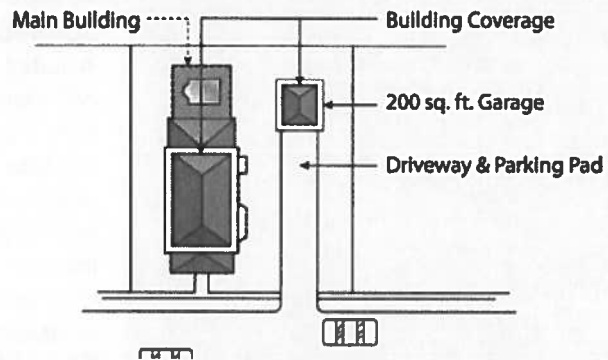

Small Lot Design Guidelines

As a follow-up to the Small Lot Ordinance, the City of Los Angeles drafted guidelines to ensure that future development fit the scale and character of the neighborhood. This includes recommendations on architecture, massing, site design, and contribution to the public realm.

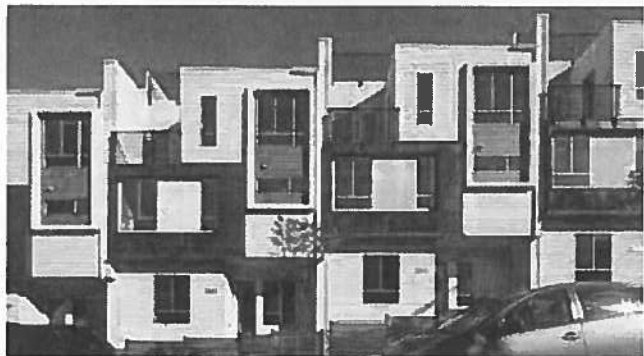

Community Land Trusts

To combat rising costs of living and displacement in Denver, working class communities such as Elyria Swansea and Globeville have established community land trusts. The basic premise is that the trust owns homes in a geographic focus area and then sells the home at an affordable rate to qualifying individuals. The land below is leased but stays as an asset of the trust.





GOAL 3:

Reconnect Mill Street People & Places

Mill Street has some great regional connections for multiple modes of transportation.

The neighborhood has immediate vehicular access to I-25, pedestrian and bike links to the Pikes Peak Greenway and the Legacy Loop as well as being within walking distance to Downtown Colorado Springs. Engagement with neighborhood community members indicated that while regional connections may be great, the neighborhood's internal connections, both physical and social are lacking. Despite the surrounding downtown activity and central location, Mill Street residents and some business owners report feeling disconnected from the rest of the city.

COMMUNICATION The planning process included a series of Listening Sessions with community members and representatives from organizations around the City. A key take-away from these conversations was the current lack of communication both within the community and between the community and the City. Rebuilding channels of communication and re-establishing the community's trust in the City will be an important step to achieve residents' goals.

PARK & OPEN SPACE CONNECTIONS

The Mill Street neighborhood is adjacent to Fountain Creek with access to the Pikes Peak Greenway and future segments of the Legacy Loop. While the neighborhood is close proximity to a number of parks, connections to and through the neighborhood and new amenities in parks would benefit residents.

MULTI-MODAL CAPABILITIES

Mill Street has some useful infrastructure for transportation, however, the conditions of these facilities and concerns about safe travel were highlighted by community members as areas needing improvement. The Mill Street neighborhood is home to many residents with disabilities as well as service providers for people with disabilities and providing access into and throughout the neighborhood is an important element to the plan.

Improve Neighborhood Communication

30. Rebuild strength and participation in the **Neighborhood Association**. Colorado Springs' neighborhood associations can be a driving force for neighborhood improvement, change and decision making. Welcoming home owners, renters, business owners and area workers to participate in the neighborhood association will help solidify a voice for the community through a channel recognized by the City.
31. Offer alternate ways, beyond the Neighborhood Association, for area residents and business owners with varying levels of capacity to participate in **community building**. Events and programming can provide opportunities for community members to connect with neighbors and learn more about ongoing efforts in the area without the need for a regular, on-going commitment.
32. Offer technical assistance for **organization building** and communications within the neighborhood association.
33. Create neighborhood **leadership opportunities** on the boards of service provider organizations.

In the public survey, improved communication between residents, businesses and the city was a top response to the question, "What do you think are important outcomes for a successful neighborhood plan?"

(SOURCE: PUBLIC MEETING, 70 RESPONDENTS)



FULL HOUSE AT
THE PUBLIC MEETING

Better Connect the Neighborhood to its Parks, Trails & Open Space

34. Work with the City of Colorado Springs Parks, Recreation and Cultural Services Department and the Parks, Recreation and Cultural Services Advisory Board to conduct a master planning process for the future of **Dorchester Park**. Residents have expressed interest in exploring alternative uses and purposes for the public space to address safety issues and the mis-alignment with the city park mission to serve all citizens. Examples of potential park uses include a dog park, fitness park, trailhead for Legacy Loop and Pikes Peak Greenway, ponds for water storage/quality management and urban forest.
35. Improve the condition and quality of neighborhood access to and from the **Pikes Peak Greenway / Legacy Loop** trail. Clear signage and wayfinding, ADA access, welcoming landscape features and safe environmental design will help re-welcome community members to the Greenway and nature experiences to be found along Fountain Creek.
36. Explore potential of existing **vacant lots** in Mill Street area to act as community amenities or gathering spaces on a short-term or long-term basis.

At the public meeting, 46% of attendees believe new park purposes should be explored, and 26% would like to see the current features repaired and maintained, 23% did not feel it needed to remain a park/city property.

(SOURCE: COMMUNITY SURVEY, 78 RESPONDENTS)

CASE STUDY: NEW BEGINNINGS SAFE PARKING PROGRAM

New Beginnings' Safe Parking Program in Santa Barbara, California provides safe overnight parking to individuals and families living in their vehicles. New Beginnings has operated the Safe Parking Program since 2004 in cooperation with numerous local churches, governmental and non-profit agencies and businesses. They provide confidential, daily-monitored parking places for those who are living in their vehicles because they do not have sufficient income to provide for their basic need of affordable housing. The program currently operates 133 safe overnight parking spaces and connects those experiencing chronic homelessness to shelters and services.



Enhance Multi-modal Capabilities of the Neighborhood

- 37. Improve **pedestrian accessibility** throughout the neighborhood. Improvements include increased sidewalk widths; connecting sidewalks; improving sidewalk conditions; the provision of ramps at key access points; and intersection improvements such as increased pedestrian crossing times at traffic lights and accessible curb ramps.
- 38. Improve **rail safety** including at-grade road crossings and addressing the structural integrity of historic overpass structures.
- 39. Explore **traffic calming** strategies (including separated bike lanes, bulbouts, rain gardens, and widened tree lawns and others described in the Experience Downtown Master Plan) to improve safety for all modes of transportation.
- 40. Encourage ridership on Mountain Metro and promote neighborhood stewardship by creating an **"Adopt-a-Stop program."**

What are the biggest connectivity / mobility challenges in the neighborhood

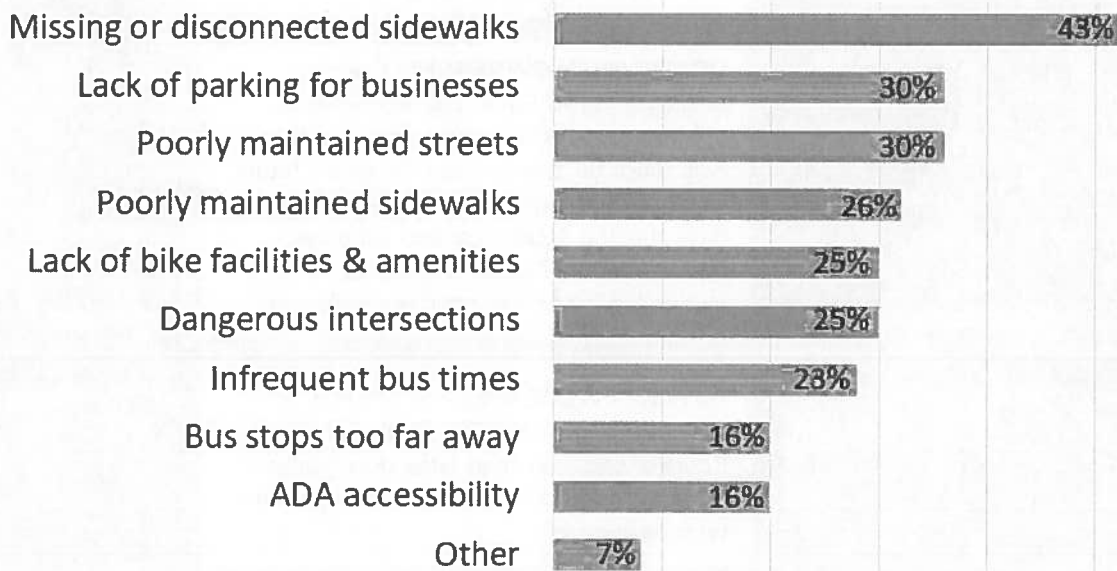

(SOURCE: PUBLIC MEETING POLLING, 70 RESPONDENTS)

GOAL 4:

Create a Resilient Future for Mill Street

Today, the Mill Street neighborhood is facing big challenges like rising rents, encroaching downtown development and evolving demographics.

As the neighborhood looks towards the future, building strength in the local business community, housing and affordability and neighborhood ownership will fortify the neighborhood and help residents respond to the evolution of the city.

LOCAL BUSINESS There are number of great local businesses in the area that serve both neighborhood residents and the region. Business owners and workers expressed interest in developing better methods for communication and collaboration to continue to provide great services and unique destinations.

AFFORDABILITY According to a recent Colorado Mesa University poll, housing affordability is the biggest issue facing Coloradans. The cost of housing in Colorado Springs is increasing at a rate faster than increases in local salaries and the challenge of affordability in Mill Street will be a threat to the current residents, over 60% of which are renters.

COMMUNITY OWNERSHIP Creating resiliency in Mill Street will require an organized and strong community voice to help make decisions about the area's future. Today, while neighborhood pride is relatively high, the area lacks clear and cohesive representation. Developing the sense of ownership in this neighborhood will help.

FUTURE INFLUENCES Mill Street is an area of change in the City. Anticipating future impacts, such as large development projects, will increase the potential for long-term resilience.

Strengthen Local Business

41. Work with the Downtown Colorado Springs Creative District, the Downtown Partnership of Colorado Springs, Pikes Peak Small Business Development Center and area property owners to attract **new businesses** that will reinforce neighborhood character.
42. Improve neighborhood accessibility to **fresh food** through the recruitment of a local grocer, regional grocery store, farmer's market, or organized Community Supported Agriculture shares.
43. Work with local business owners to identify funding for **façade improvements** along the Tejon and Nevada commercial corridors.
44. Encourage creation of a local **community development** corporation to create jobs, generate revenue, improve neighborhood outcomes, and provide critical goods and services.
45. Help local businesses organize and work together on future **funding opportunities** through programs like the local Economic Opportunity Zones program, the federal Opportunity Zone program, and Lodgers and Automobile Rental Tax (LART).

In the survey, 45% of respondents said that 'housing affordability solutions' was one of the most important outcomes for a successful neighborhood plan.

(SOURCE: COMMUNITY SURVEY, 78 RESPONDENTS)

Preserve Neighborhood Affordability

46. Create policy for the Mill Street neighborhood to encourage **residential affordability**. Policies may include incentives for infill housing that features new housing types (garden apartments, accessory dwelling units, townhomes or duplexes) that accommodate higher density and diverse price points and are architecturally consistent with the neighborhood.
47. Encourage mixed use and **mixed-income development** in the neighborhood.
48. Incentivize **mixed use development** throughout the neighborhood. Examples of incentives may include permit fee reductions, tax abatements, expedited development approval processes and providing density and building height or floor area bonuses.
49. Work with **local land trusts** in expanding capacity and securing affordable home rates in the Mill Street neighborhood.
50. Prioritize the Mill Street neighborhood when pursuing CDBG funding for acquisition, architectural barrier removal and **housing rehabilitation** programs. Promote use of local building professionals when possible.
51. Explore opportunities to create affordable **rental housing** and increasing homeowner equity by replacing single family homes in severe disrepair with duplexes.
52. Use HOME funds for construction of **Accessory Dwelling Units** for low-income households to add density and create financial stability.
53. Highlight goal to create and preserve **affordable housing** in resolution to plan adoption to make case for review standards, future community benefit agreements, and possible improvement district.

Promote Community Ownership

54. Expand reach of **volunteer programs** to include neighborhood events and programming, fostering neighborhood celebration and social engagement.
55. Improve private property **maintenance** by issuing warnings for non-compliance.
56. Improve the appearance of planting in **street medians**. Identify a "Friends Of..." group of volunteers to work with the Springs in Bloom program to install and maintain attractive installations along vegetated medians. Improvements may include the installation of art work, perennial or annual plantings or seasonal enhancements such as holiday lighting.

Anticipate Future Influences

57. Support redevelopment of the **Drake Power Plant** site to include land uses that are beneficial to the Mill Street Neighborhood. A mix of uses that residents expressed would be appropriate include an entertainment district, new park or recreation area, small business district, affordable/attainable housing, and public institutions or service providers.
58. Support bike and pedestrian connectivity to the **Shooks Run** improvements.
59. Study opportunities for **rail public transit** as the need for local freight service dissipates with the decommissioning of the Drake power plant.
60. Work with the **stadium** on the development of public space and how to make it accessible for residents.



At the public meeting, "decommissioning of the Drake Power Plant" was the #1 response to the question: "What possible 20+ year changes do you think could be most beneficial to the neighborhood?"

(SOURCE: PUBLIC MEETING, 70 RESPONDENTS)

CASE STUDY: AFFORDABLE HOUSING STRATEGIES

Minimize costs for renters

Emergency Repair Program—the City of Colorado Springs' Energy Resource Center weatherizes homes for low-income and middle income households, including separate funding for emergency repairs.

Weatherization Assistance Program—federal program to states that provides funds to make capital improvements towards energy efficiency and reduction of greenhouse emissions.

Provide resources for homeowners

Housing Rehabilitation Program—City of Colorado Springs' Housing Department sponsors rehabilitation construction projects to qualifying low-income and moderate-income households. Sub-programs include: owner occupant rehabilitation program, barrier removal program, emergency repair program and lights and locks for seniors program.

Single Family "Turnkey" Mortgage—El Paso County provides competitive 30-year fixed-rate mortgages with a down payment assistance grant (DPA) up to 4% for low and moderate income homebuyers.

Tax Abatements—freeze taxes at a certain level to incentivize owners to invest in the renewal of their rental properties (ex. New York).

Streamlined Financing—local governments can streamline process for financing rehabilitation projects as an incentive to owners.

Preserve affordable rental units

One-to-One Replacement—San Diego requires a one-to-one replacement of any affordable rentals that are razed, removed from the stock or converted to condos, by city code.

Community Benefit Agreement—Stipulate that developers in rapidly growing areas, such as TOD's, have to preserve or provide affordable or rental housing.

Acquisition Funds—Denver provided TOD acquisition funds and grant funds to nonprofits that buy affordable housing near transit centers.

Incentivize affordable housing

Designate TIF funds for affordable housing—devote a portion of revenue from the tax increment financing district towards affordable housing (e.g. California and Chicago) or preservation (e.g. Atlanta, Kansas City and Austin).

Bridge Financing—set up public / private initiative to provide loans to developers pursuing preservation or affordable projects to enable acquisition and pay upfront "soft costs."



WHAT IF...

Big Moves Ahead

Over the next 20 years, the Mill Street Neighborhood will be impacted by major public / private initiatives.

Anticipating influences from the surrounding area and potential for redevelopment within the neighborhood helps the Mill Street Neighborhood be proactive in directing the type of place that they want to become. Four big moves could be harnessed to have positive outcomes for the neighborhood, but these opportunities may have unintended negative impacts, such as increased unaffordability for residents.

POWER PLANT REPURPOSING The closure of Drake Power Plant is currently set for 2035. Repurposing of the power plant site will create opportunities as well as challenges for the Mill Street neighborhood. Mill Street residents will continue to be engaged in the future of the site.

FUTURE OF RAIL The Department of Public Works is beginning a planning effort in late 2018 to examine options for replacing aged rail bridges. Advocating for the interest of the Mill Street neighborhood will be ongoing work.

REIMAGINE DORCHESTER In outreach for this project, city stakeholders, service providers and community members expressed concern about the challenging conditions at Dorchester. The Legacy Loop offers an opportunity to activate the Park and further work is needed to make the park safe and active.

INVEST IN NEIGHBORHOOD As an inner city neighborhood, the urban fabric of Mill Street and how it connects to and through the City is vital. With a stadium recently announced for the CityGate site, improvements should benefit the neighborhood, such as new public amenities, job opportunities and additional attainable housing units.

WHAT IF... BIG MOVES AHEAD

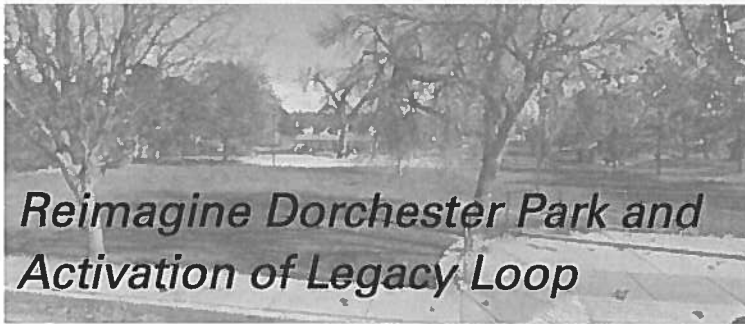
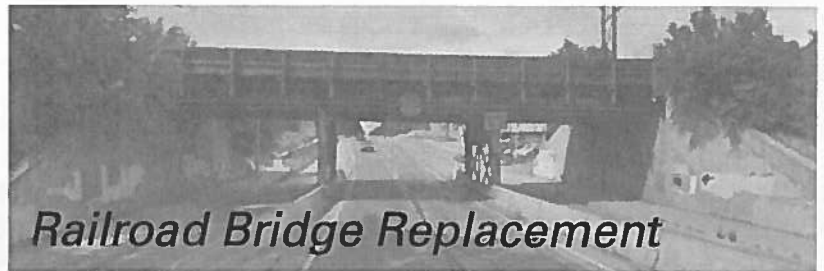
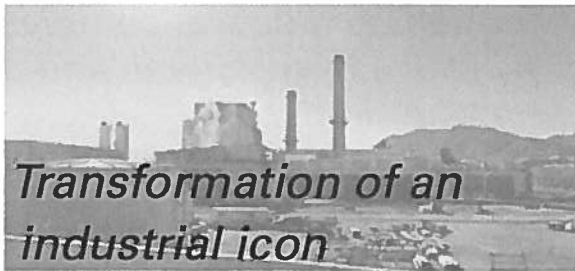

What will the Mill Street neighborhood look like in 20 years? How do changes in the neighborhood stand to benefit the community? Imagine: What if we designed our city for compassion and upward mobility?

Mill Street residents are bracing for change happening all around their historic community and across the Front Range. As plans for surrounding communities are modified, updated and implemented, it will be important that the Mill Street Neighborhood plays a key role in envisioning the edges and exchanges between the area and its neighbors.

Experience Downtown provides the backdrop for testing ideas about the future. The map studies on the following pages play out two scenarios to explore how area land uses might change in response to anticipated land use changes, infrastructure updates and development projects surrounding the area. Potential changes on the horizon include: repurposing of the Drake Power Plant site to new land uses, replacement of two railroad bridges with related pedestrian improvements and trail connections, consideration of the rail corridor, re-activation of Dorchester Park, and the influence of nearby projects such as the new outdoor stadium at CityGate.

These changes are mostly viewed as positive improvements to quality of life and health, and could increase desire to live, work, and own property in this location. The following scenarios ask what would the composition of the neighborhood land uses look like if these potential future opportunities and challenges were addressed. What does an inclusive land use map look like? As these major initiatives unfold, community members are encouraged to use this plan to recommend future land use changes that enable affordability, inclusion, safety, and accessibility.

These studies are intended to spur conversation in the Mill Street Neighborhood and gain feedback about what types of uses residents and business owners would like to see in their community, while still maintaining the strength of their residential core.

WHAT IF... SCENARIO A

Scenario A explores the possibility of an entertainment and sports complex with park lands and residential infill to replace the Drake Power Plant, and a commercial corridor extending east / west along Las Animas.

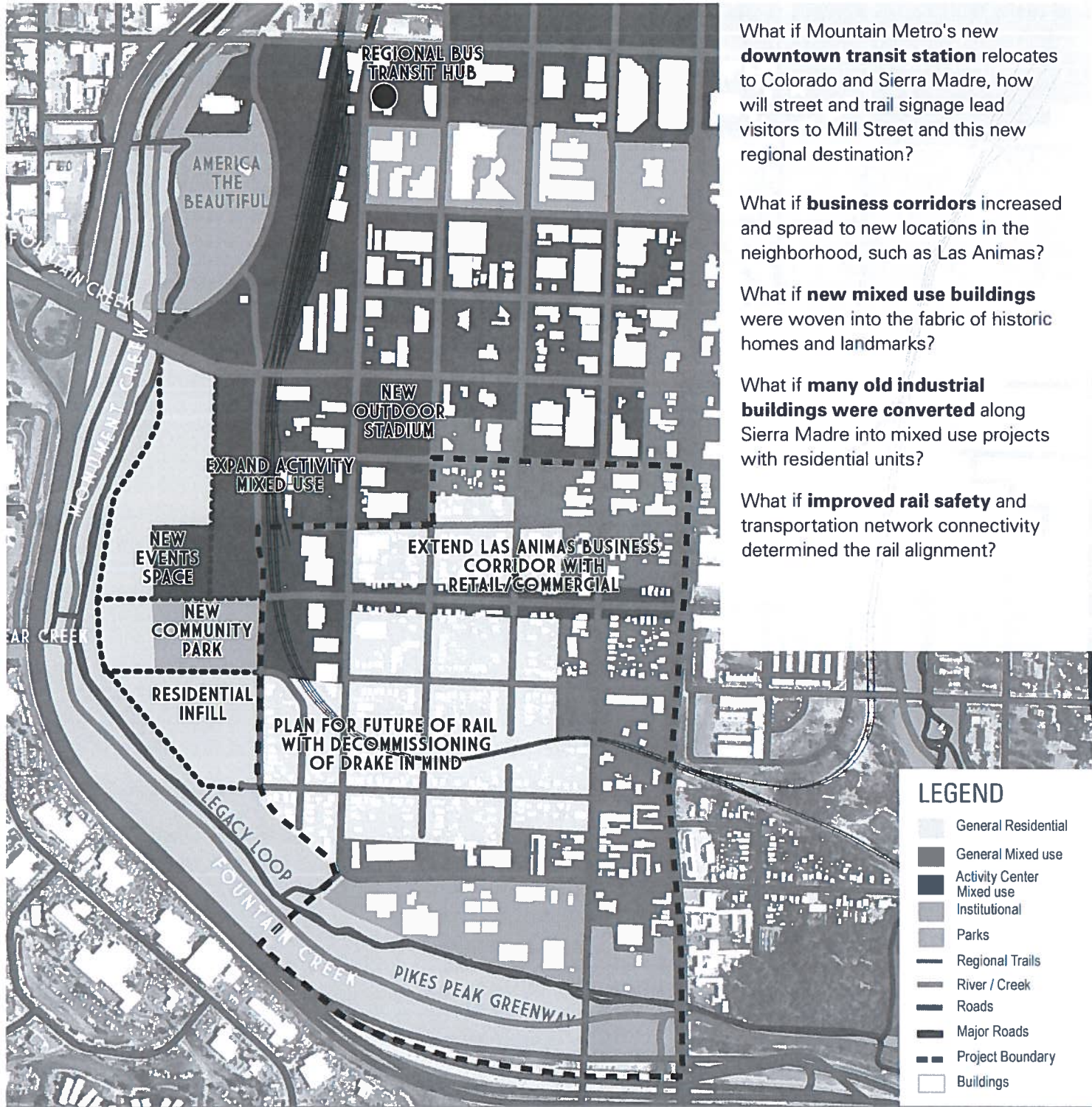

What if Mountain Metro's new **downtown transit station** relocates to Colorado and Sierra Madre, how will street and trail signage lead visitors to Mill Street and this new regional destination?

What if **business corridors** increased and spread to new locations in the neighborhood, such as Las Animas?

What if **new mixed use buildings** were woven into the fabric of historic homes and landmarks?

What if **many old industrial buildings were converted** along Sierra Madre into mixed use projects with residential units?

What if **improved rail safety** and transportation network connectivity determined the rail alignment?



WHAT IF... SCENARIO B

Scenario B explores the possibility of a primarily residential and park project to replace the Drake Power Plant with a regional activity zone on the north end of the Drake site and extending eastward.

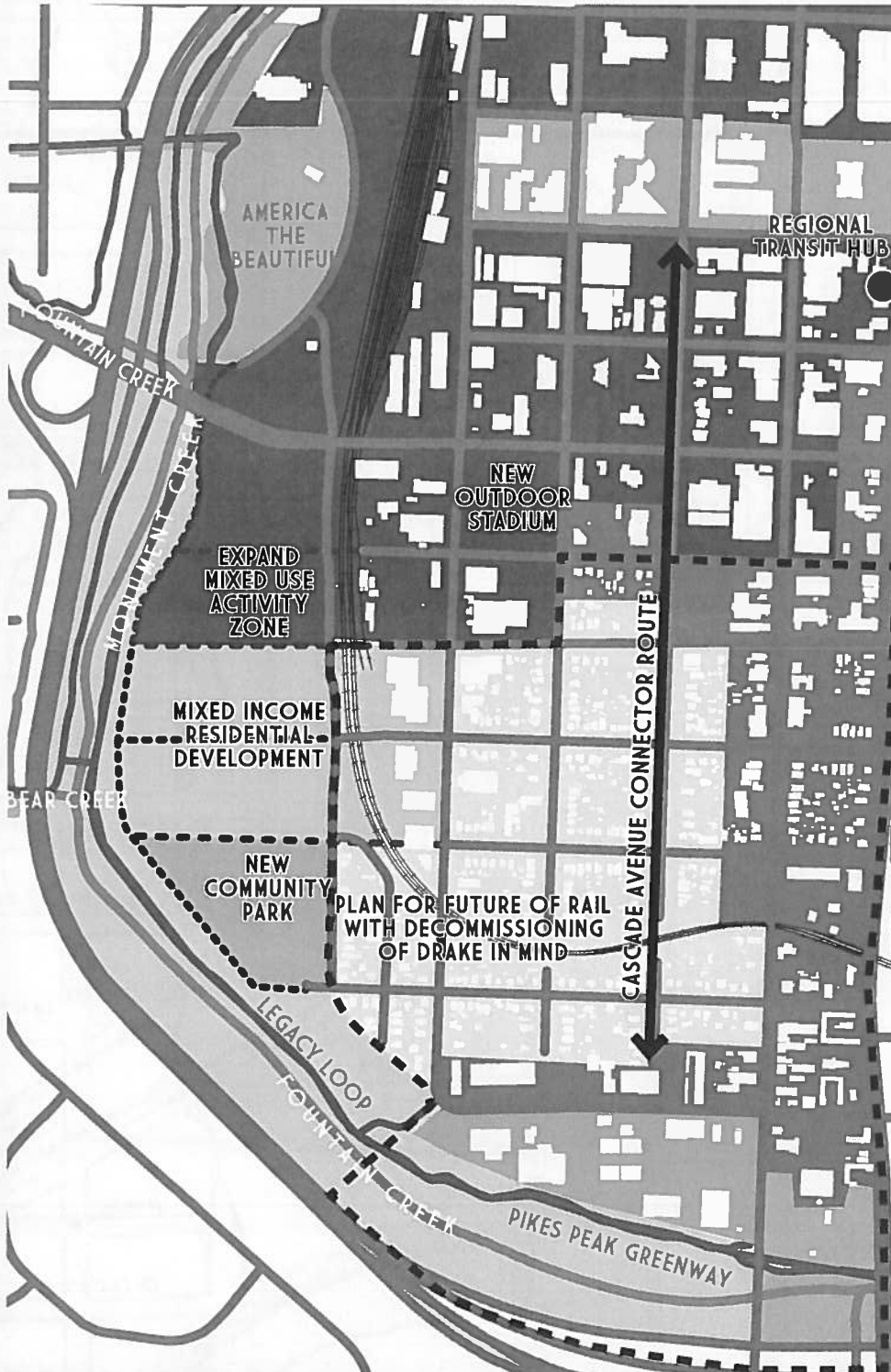

What if our **streets are oriented** to lead residents and visitors to this regional destination?

What if Mountain Metro's new **downtown transit hub** relocates to Costilla and Pueblo? How would street and trail signage lead visitors to Mill Street and the regional activity zone?

What if **Cascade were a connector** route from the Mill Street to the heart of downtown?

What if a **new park** connected with the current green infrastructure and residential areas?

What if the majority of the neighborhood became general **residential land use**, with heavier mixed uses focused north of the area?

What if **improved rail safety** and transportation network connectivity determined the rail alignment?



LEGEND

- General Residential
- General Mixed use
- Activity Center
- Mixed use
- Institutional
- Parks
- Regional Trails
- River / Creek
- Roads
- Major Roads
- Project Boundary
- Buildings

MILL STREET NEIGHBORHOOD
EXPLORING NEW DENSITIES

400' 800' 1,600' 3,200'



ACTION PLAN

Action Plan Priorities

Enhance Quality of Life for Mill Street Residents

Cultivate Mill Street Character

Reconnect Mill Street People & Places

Create a Resilient Future for Mill Street



ACTION PLAN

The action plan identifies a series of short-term strategic steps to implement over the next several years.

The following section is a roadmap on how to address key community concerns and implement short-term projects that will benefit the neighborhood. The action plan provides a timeline, relative cost, funding source and responsible parties for each item.

ACTION PLAN PRIORITIES

The two most pressing priorities expressed by community member through engagement were:

1. *Improve neighborhood safety and cleanliness.*
2. *Sustain the affordability of the neighborhood.*

First and foremost, people want actions to be taken that help them stay in this neighborhood. Both unsafe street and trail conditions and rising housing costs have caused long-term residents and business owners to relocate or feel pressure to move elsewhere. These priorities do not diminish the importance of the other needs expressed by residents that would improve quality of life in the neighborhood. For example, prioritizing affordability may limit opportunities for preservation or development. With these kinds of tough tradeoffs in mind, the plan sought to deliver the greatest benefit to the whole Mill Street community. Many related or supportive actions can begin to take place immediately to demonstrate a commitment to the neighborhood. Other items listed in this action plan may not relate to a top priority but acknowledge that small steps are needed now to cover a long distance. The implementation of this plan is not possible without the sustained engagement and buy-in of community members. They are the heart of the neighborhood and are integral at every stage.

The acronyms below are used in the following Actions tables under Responsible Parties + Partners and Funding Sources:

ADU = Accessory Dwelling Unit
CDD= Community Development Division
CONO= Council of Neighbors & Organizations
CSPD = Colorado Springs Police Department
DPW= Department of Public Works
MSNA= Mill Street Neighborhood Association
SRM= Springs Rescue Mission
PRCS= City of Colorado Springs Parks, Recreation and Cultural Services Department
CSED= Colorado Springs Economic Development

HOW TO USE THIS ACTION PLAN

The goals presented in Chapter 3 provide definition and a long-term view of how these priorities fit together. The following Implementation Action Plan is a “how to” detailed list of near-term action items to be implemented over the short-term. The Budget Office has done an initial Fiscal Impact Analysis on the plan, available in the Appendix.

Over time, the specific actions to address the goals are likely to change. In addition, all actions requiring funding will need to be approved or granted by a funding entity. The intent is to provide a plan for action and should not be construed as a promise. To get involved in making these happen, consider joining the plan’s Implementation Team. Contact communitydevelopment@springsgov.com for more details.

The Action Plan tables include:

- Description of actions
- Responsible parties and partners
- Relative costs
- Potential funding sources
- Implementation timing

GOAL 1:

Enhance the Quality of Life for Mill Street Residents

ACTION	TIMING	RELATIVE COST	FUNDING SOURCE	RESPONSIBLE PARTIES
Assess environmental conditions specific to the Mill Street neighborhood.				
Work with the El Paso County Air Quality Program to add air quality monitors in the Mill Street neighborhood in accordance with EPA standards. Create an action plan for improving air quality conditions.	year 1	0	N/A	CDD, El Paso County
Organize neighborhood support for a public health study.	year 1	0	N/A	MSNA, CONO
Conduct a train noise assesment through Nevada Tejon Rail Corridor Study to include solutions for the Mill Street Neighborhood.	year 1	\$	N/A	DPW
Improve environmental conditions along neighborhood rights of way and the Pikes Peak Greenway.				
Work with area service providers, neighborhood volunteers and the City to increase maintenance and trash clean up along the trail.	ongoing	\$	TBD	MSNA, SRM, CONO, PRCS
Organize community cleanup group to regularly maintain trash bins along the trail and throughout the neighborhood.	ongoing	\$	TBD	PRCS, MSNA, CONO
Strengthen relationships with partners in DPW, Keep CoS Beautiful, US Green Building Council, CSU, and CONO to augment cleanup efforts.	ongoing	0	partner organization time	MSNA, SRM, CONO, PRCS, DPW
Work with City's Homeless Response and Prevention Coordinator to develop and support a "Shelter to Work" plan to engage homeless.	ongoing	0	staff time	CDD, COS
Coordinate trail lighting improvements with CDD funded neighborhood lighting improvments.	year 2	\$\$\$	CDD	DPW, PRCS
Continue to identify resources for cleanup, community groups, nonprofit entities, and grassroots organizations.	year 3	\$	to be determined	MSNA, CDD

ACTION	TIMING	RELATIVE COST	FUNDING SOURCE	RESPONSIBLE PARTIES
Upgrade lighting in neighborhood to improve safety.				
Convene community members through MSNA to discuss safety issues in the neighborhood and identify focus areas. Invite community liasons from SRM and CSPD to participate in discussion.	year 1	0	N/A	MSNA, SRM,CSPD
Conduct an audit of existing street lighting and reports to verify key locations to improve lighting.	year 1	\$	CDD	CDD
Dedicate resources from the 2018 CDD Mill Street funds for improved lighting.	year 1	0	N/A	CDD
Install new street lights at specified locations.	year 2	\$\$	CDD	DPW
Increase local rule enforcement in the Mill Street neighborhood.				
Host a neighborhood meeting with local officers to discuss areas needing increased police attention. Community comments during the planning process indicated that both the Pikes Peak Greenway and Dorchester Park require increased policing and rule enforcement.	year 1	CSPD officer time	CSPD	CSPD, MSNA
Schedule quarterly "Officer Updates" at neighborhood association meetings to communicate successes and failures of increased police presence at identified locations.	on-going quarterly	CSPD officer time	CSPD	CSPD, MSNA
Track incidences in identified locations to study the success of the program and potential applicability for other city neighborhoods experiencing and safety issues.	year 1-3	CSPD officer time	CSPD	CSPD, MSNA

ACTION	TIMING	RELATIVE COST	FUNDING SOURCE	RESPONSIBLE PARTIES
Revisit a Good Neighbor Agreement with area service providers, Mill Street Neighborhood Association and City of Colorado Springs Community Development.				
Convene shelter providers, residents, business owners, and City to revisit the Good Neighbor Agreement or similar agreement that identifies roles in managing high-risk populations in the neighborhood.	year 1	0	agency staff time	MSNA, area service providers, CSPD, CDD, residents & businesses
Identify a resource to track and report the metrics for a Good Neighbor Agreement with the City and the Neighborhood Association.	year 2	staff time	CDD	MSNA, SRM, CDD
Add metrics to draft agreement for tracking performance.	year 2	staff time	CDD	CDD
Create a space for resident involvement on SRM Board. Aim for more than "outreach" but rather reciprocity.	ongoing	0	N/A	SRM, MSNA
Institute a community liaison to build relations and communication between service providers and neighborhood groups.	ongoing	0	N/A	MSNA, CONO, SRM
Determine enforcement strategy for non-compliance and leverage federal grant dollars for neighborhood engagement and communication.	ongoing	\$	TBD	SRM, MSNA, CDD
Designate a location and pursue grant funding to create a restorative garden for the Springs Rescue Mission campus.	year 2	\$	Grants	SRM, CONO
Support neighborhood celebration events.				
Dedicate small annual budget from CONO to help support events generated by the Mill Street community. Some examples of include: neighborhood block party, holiday caroling, community bazaar, parade, potluck event, music jam session or neighborhood crawl.	years 1-3	\$\$	CONO	MSNA, CONO, residents and businesses
Create publicity and communications training for neighborhood association members to build local capacity for event planning and publicity.	years 1-3	\$	CONO	MSNA, CONO, residents and businesses

GOAL 2:

Cultivate Mill Street Character

ACTION	TIMING	RELATIVE COST	FUNDING SOURCE	RESPONSIBLE PARTIES
Support the preservation and restoration of historic buildings and neighborhood character.				
Include the Mill Street Neighborhood in the City of Colorado Springs Historic Preservation Plan with strategies appropriate for this neighborhood.	year 1	0	N/A	CDD
Gather historical information about the area to establish its significance. Examine the individual properties within the area to determine how much and in what ways they have changed over time.	year 2	\$	TBD	MSNA, CDD, CS Historic Preservation Alliance
Conduct an inventory and survey per State Historic Preservation Office standards of properties and features of historic significance. Prepare nomination forms and submit to the State Office of Archaeology and Historic Preservation.	year 2	\$	TBD	MSNA, CDD
Use the results of the survey to evaluate character-defining buildings for their suitability for designation as a landmark structure, a Colorado Springs Historic District or a cultural landscape.	year 3	\$	TBD	MSNA, CDD
Assess opportunities to re-establish historic street tree planting and vegetation in consideration of maintenance and watering considerations.	year 1	\$	TBD	City Forestry

ACTION	TIMING	RELATIVE COST	FUNDING SOURCE	RESPONSIBLE PARTIES
Showcase the neighborhood history through public exhibits.				
Work with staff at the Colorado Springs Pioneer Museum or Pikes Peak Library District to develop a Mill Street exhibit, celebrating the resilience of one of Colorado Springs' oldest neighborhoods.	year 2	\$	TBD	MSNA, Colorado Springs Pioneers Museum and/or Pikes Peak Library District
Develop an exhibit to showcase collected oral histories, incorporating key stories from the <i>Once Upon a Neighborhood</i> document.	year 2	\$	TBD	MSNA
Promote the Mill Street name and identity within the study area boundary.				
Update city neighborhood mapping to include the current boundaries of the Mill Street Neighborhood in City maps.	year 1	0	N/A	Planning
Work with local businesses and residents to adopt Mill Street as a neighborhood name in signage, marketing and branding.	year 2	\$	TBD	MSNA, CDD, CONO, CSED
Conduct a neighborhood identity and branding process with a consultant and local artists to draw out resident and business owners' image of the neighborhood.	year 2	\$	TBD	MSNA, CDD, CONO
Create neighborhood entryway landmarks or gateways designed and built with neighborhood talent and reflective of the area's historic relevance.				
Develop a gateway and signage design and installation plan informed by the neighborhood-led identity and branding process.	year 2	\$	TBD	MSNA, CDD, CoS
Put out an open call to local artists and fabricators to contribute to the design and construction and keep money in the local economy- such as opportunities for the Nevada & Tejon Rail Bridge Replacement project aesthetics.	year 2	0	Infrastructure funding	MSNA, CDD, CoS, Downtown Partnership
Plan for funding of gateway installation and ongoing maintenance.	year 3	\$\$	TBD	MSNA, CDD, CoS, Downtown Partnership

GOAL 3:

Reconnect Mill Street People & Places

ACTION	TIMING	RELATIVE COST	FUNDING SOURCE	RESPONSIBLE PARTIES
Develop a Communication Toolkit for the Neighborhood Association.				
Work with neighborhood residents to develop a toolkit to better communicate among each other, with area service providers and the City. The toolkit should be a resource for all parties and include both informal strategies (e.g. social media, drop-in events) and formal strategies (e.g. community liasons, engagement in public process) engaging in productive conversation and decision-making.	year 1	\$	CONO	CONO, MSNA, City Communications
Strengthen neighborhood relationship with CONO to leverage institutional knowledge and capacity of the organization to serve as a neighborhood liason.	year 1	0	staff time from CONO	CONO, MSNA
Re-establish regular publication of The Grist, MSNA's neighborhood newsletter with increased circulation to accommodate new boundaries. Interested residents should work with the Neighborhood Association to write pieces and edit the newsletter.	year 1	\$	TBD	CONO, MSNA
Identify funding for the production of communications materials and other tools identified in the communications toolkit.	year 2	\$	TBD	CONO, MSNA
Test new programs and uses in Dorchester Park.				
Work with PRCS to conduct a visioning session with residents, business owners and community members on the future of Dorchester Park.	year 2	0	CDD & PRCS staff time	PRCS, CDD, MSNA
Coordinate with SRM to survey homeless community members on desired amenities and safe use of the park.	year 2	\$	SRM staff time	SRM, PRCS
Follow established Parks Department procedures, including its master plan process as applicable, to vet ideas (dog run, fitness equipment, regional purpose, food trucks) to test pilot programs.	year 3	\$\$\$	TBD	PRCS, CDD, MSNA
Partner with PRCS to use CDD Mill Street funds to finance pilot programs and explore Community Development Block Grants (CDBG) as further funding source.	year 3	\$\$	CDD	PRCS, CDD, MSNA

ACTION	TIMING	RELATIVE COST	FUNDING SOURCE	RESPONSIBLE PARTIES
Improve the character and quality of the Pikes Peak Greenway at Las Vegas Street and Sierra Madre Street trail access point.				
Identify funding for the following improvements: pathway paving and ADA accessible design; Crime Prevention through Environmental Design; Safe Routes to parks signage and wayfinding to/from the neighborhood; trail entry landscape features and seating.	year 3	\$\$\$	PRCS, Bike improvement fund	PRCS
Participate in the Colorado Springs Adopt a Park/ Trail Program to care for the trail access point.	year 2	\$	TBD	MSNA, volunteers
Partner with the Department of Public Works to improve street conditions and public rights of way.				
Create inventory of all pedestrian intersections in the study area, including information on signalized crossings, condition of sidewalk, timeline for renewal, presence of ramp, detectable warning strips, etc.	year 1	\$	COSDPW	COSDPW
Identify priority intersections for improvement.	year 1	\$	COSDPW	COSDPW
Host community meeting to present locations for improvements and assess public priorities.	year 1	0	CDD, COSDPW staff time	CDD, COSDPW
Repave portions of S. Nevada Ave	year 1	\$\$	COSDPW	COSDPW
Repave portions of Sahwatch St, W. Rio Grande and W. Moreno Ave	year 2	\$\$	COSDPW	COSDPW
Improve pedestrian crossing at Sierra Madre railline intersection	year 3	\$\$\$	COSDPW	COSDPW
Apply for CoS Missing Sidewalks Program to fund further improvements and explore additional programs, such as Trail Fund and Safety Fund.	year 3	\$	COS	COSDPW, CDD
Create an "Adopt-a-Stop" program for bus stops.				
Inventory current bus stops and permanent bus shelters in the study area.	year 1	\$	CDD	CDD, Mountain Metro
Review summary with Mountain Metro to identify possible locations for permanent bus shelters and popular stops.	year 1	\$	CDD	CDD, Mountain Metro
Conduct outreach to local businesses to find potential "adoptees" for a pilot project.	year 2	0	N/A	CDD, local businesses
Establish best practices and standard levels of care for adopted stops.	year 2	\$	CDD	CDD
Engage the neighborhood in major redevelopment projects.				
As major redevelopment projects, such as the stadium at CityGate, the closure of the Drake Power Plant and the replacement of the railroad bridges, move forward, coordinate Mill Street neighborhood meeting with Planning Department.	Ongoing	\$	Staff time, project owner time	Planning, CSURA, project owners

GOAL 4:

Create a Resilient Future for Mill Street

ACTION	TIMING	RELATIVE COST	FUNDING SOURCE	RESPONSIBLE PARTIES
Form a Mill Street Business Association to help voluntary business owners manage maintenance, development and promotion of their neighborhood.				
Meet with local businesses to identify potential members.	year 1	0	CDD, CSED staff time	Local Businesses, CDD, CSED
Work with the City and the Pikes Peak Small Business Development Center to organize a vision and mission and host a first meeting.	year 1	0	CDD, CSED staff time	Local Businesses, CDD, CSED, Chamber & EDC
Coordinate meetings, programs and events with the Mill Street Neighborhood Association.	year 1	\$	CDD, CSED	CDD, CSED, Chamber & EDC
The Business Association may take ownership of relevant recommendations laid out in this plan and serve as partners in the pursuit of implementation.	year 2	0	CDD, CSED	Local Businesses
Develop an historic preservation and home rehabilitation program for low-income homeowners in historic homes.				
Work with the City-wide Historic Preservation Master Plan team to identify opportunity sites for historic home rehabilitation.	year 1	\$	To be identified	CDD
Make Mill Street neighborhood a target area for housing rehabilitation programs.	year 1	0	CDD staff time	CDD, Brothers Redevelopment
Identify local developers and contractors with historic preservation experience to serve on a Historic Home Rehabilitation Advisory Committee. The committee will help identify resources, materials and key construction considerations.	year 2	\$	CDD staff and volunteer time	CDD, HPA, select construction firms
Work with local preservation partners, such as the Colorado Office of Archaeology & Historic Preservation and the Historic Preservation Alliance to identify funding streams to low-income Mill Street homeowners.	year 2	\$	TBD	CDD, nonprofit partners
Develop an application program and work with homeowners to pursue funding.	year 3	\$	HPA, CoS	HPA, CoS

ACTION	TIMING	RELATIVE COST	FUNDING SOURCE	RESPONSIBLE PARTIES
Provide resources for affordable infill projects.				
Make HOME funds available for low-income homeowners whose housing rehabilitation applications are denied due to excessive repair costs. If rehabilitation can't be done, rebuilding the home with additional units is an option.	year 1	0	N/A	CDD; Homeowners
Once constructed, the homeowner would live in one unit and rent out the remainder as affordable units for a set period. After affordability period ends, the homeowner keeps the added equity and the neighborhood has added density.	year 3	\$\$	HOME	CDD, Homeowners
Promote the construction of Accessory Dwelling Units as an affordable housing and wealth-building tool.				
Represent Mill Street in the Planning department's study of a citywide ADU ordinance (e.g. lot size, maximum lot coverage, etc).	year 1	0	N/A	CDD
If citywide ADU ordinance does not pass, create ADU unit overlay district for Mill Street study area.	year 2	\$	TBD	Planning
Assist low-income homeowners with funding of ADU construction by leveraging HOME funds.	year 2	\$\$	HOME program	CDD, Homeowners
Introduce more affordable housing in neighborhood through HOME loans, which stipulate rents must be at or below fair market rate (FMR) for ten years or homeowner must pay back construction costs.	year 3	0	HOME program	CDD, Homeowners
Engage new and long-term residents in a place-based program, such as the Community Garden.				
Work with the neighborhood association to reach out to new volunteers to plant and maintain the community garden.	year 1	0	N/A	MSNA
Organize a local market or farm stand and "market days" events at the Community Garden street. Use opportunities to engage Springs Rescue Mission and residents at this central space.	year 1	\$	TBD	MSNA, SRM
Address community interests when planning for the replacement of the S. Nevada/ S. Tejon rail bridge.				
Rail bridge replacement design should seek to improve conditions for the neighborhood such as noise reduction, air quality, pedestrian and vehicular movement and connectivity, safe crossings, neighborhood aesthetics, and opportunity for a neighborhood gateway feature.	year 1-3	\$	TBD	DPW, UPRR/BNSF
Encourage participation from residents and businesses in providing input regarding rail changes.	year 1-3	\$	TBD	CONO, MSNA, DPW

RAS DE GUGHARRAS

273

111

Alamo
112
Square

113

114

VERMIJO

E

270

121

5 FR. D.
2 BR. "
3 FR. B.
122
4 FR. D.
5 " B.

NEVADA
PUEBLO
1 FR. CH
5 " DW
123
9 FR. D.
2 " B.

22 FR.
12 "

124

COSTILLO

E

267

131

11 FR. D.
132
4 FR. B.

14 FR. DW
1 BR. "
133
6 FR. B.

9
1
A
134
3 FR. D.
1 " B.

CIMARRON

E

264

141

14 FR. D.
10 " B.
142
1 FR. CARR.
SHOP

1 BR. D.
1 ST. "
143
18 FR. D.
4 " B.

14

MORENO

& SWEETS

259

2
FOOTES
258
SUB-DIV.

FRANCE
257^{8 F. D.}
5 " B.
SUB-DIV.

HUMPHREY &
SUM 256 MERS
SUB-DIV.

25

RIO GRANDE

E

100

SPRINGS

CO'S

ADD'N

