

TRAFFIC IMPACT STUDY

For

**Allaso Briargate
Colorado Springs, Colorado**

January 2022

Revised:

March 2022

Prepared for:

Titan Development
6300 Riverside Plaza Lane NW, Suite 200
Albuquerque, New Mexico 87120

Prepared by:



SM ROCHA, LLC

TRAFFIC AND TRANSPORTATION CONSULTANTS

8703 Yates Drive, Suite 210
Westminster, Colorado 80031
(303) 458-9798

6 South Tejon Street, Suite 515
Colorado Springs, Colorado 80903
(719) 203-6639

Project Engineer:
Brandon Wilson, EIT

Engineer in Responsible Charge:
Fred Lantz, PE



21-111555

Table of Contents	Page
I. Introduction	1
Project Overview.....	1
Study Area Boundaries	1
Site Description.....	1
Existing and Committed Surface Transportation Network.....	5
II. Existing Traffic Conditions	6
Existing Traffic Analysis Results	9
III. Future Traffic Conditions Without Proposed Development.....	10
Background Traffic Analysis Results – Year 2024	13
Background Traffic Analysis Results – Year 2042	14
IV. Proposed Project Traffic	16
Trip Generation.....	16
Adjustments to Trip Generation Rates	17
Trip Distribution.....	17
Trip Assignment.....	17
V. Future Traffic Conditions With Proposed Developments.....	19
VI. Project Impacts	22
Peak Hour Intersection Levels of Service	22
Total Traffic Analysis Results Upon Development Build-Out	23
Queue Length Analysis.....	24
VII. Conclusion	25

List of Figures

Page

Figure 1 – Location.....3
 Figure 2 – Site Plan.....4
 Figure 3 – Existing Traffic Volumes & Intersection Geometry7
 Figure 4 – Background Traffic Volumes & Intersection Geometry – Year 2024..... 11
 Figure 5 – Background Traffic Volumes & Intersection Geometry – Year 2042..... 12
 Figure 6 – Distribution and Site Generated Assignment.....18
 Figure 7 – Total Traffic Volumes & Intersection Geometry – Year 2024.....20
 Figure 8 – Total Traffic Volumes & Intersection Geometry – Year 2042.....21

List of Tables

Page

Table 1 – Intersection Capacity Analysis Summary – Existing Traffic8
 Table 2 – Intersection Capacity Analysis Summary – Background Traffic – Year 2024 13
 Table 3 – Intersection Capacity Analysis Summary – Background Traffic – Year 2042 14
 Table 4 – Trip Generation Rates 16
 Table 5 – Trip Generation Summary 16
 Table 6 – Intersection Capacity Analysis Summary – Total Traffic – Year 202422
 Table 7 – Intersection Capacity Analysis Summary – Total Traffic – Year 204223

Appendices

APPENDIX A TRAFFIC COUNT DATA
 SIGNAL TIMING INFORMATION
 APPENDIX B LEVEL OF SERVICE DEFINITIONS
 APPENDIX C CAPACITY WORKSHEETS

I. Introduction

Project Overview

This traffic impact study addresses the capacity, geometric, and control requirements associated with the development entitled Allaso Briargate.

This traffic impact study has been revised to address neighborhood comments received during meeting conducted on February 3, 2022, and City review comments dated February 28, 2022, concerning analysis of Dynamic Drive and Lexington Drive intersection, inclusion of adjacent school (Mountain Ridge Middle School) traffic within this study, collected traffic counts adjustments for pandemic, and clarification of site access traffic distribution.

This proposed development consists of a multifamily residential community. The development is located near the southeast corner of Chapel Hills Drive and Dynamic Drive in Colorado Springs, Colorado.

Study Area Boundaries

The study area to be examined in this analysis encompasses Chapel Hills Drive from Research Parkway north to Dynamic Drive and includes the existing site access intersections along Research Parkway and Dynamic Drive.

The study area presented in this study was reviewed and approved by City Traffic Engineering in advance of study preparation. The Lexington Drive and Dynamic Drive intersection (serving the nearest school - Mountain Ridge Middle School) was considered but deemed unnecessary to include in the study area since the intersection is approximately one-half mile away from the site development access proposed on Dynamic Drive. Additionally, it was concurred that the nature of proposed land use, resulting traffic generation, and distribution of proposed traffic (being a minor amount) to the distant signalized intersection is not expected to cause a negative impact to current intersection operations or school access.

Figure 1 illustrates location of the site and study intersections.

Site Description

Land for the development is partially occupied by a parking lot and surrounded by a mix of residential and commercial land uses.

The proposed development is understood to entail the new construction of two 3-story multifamily residential buildings supporting a maximum of 300 dwelling units with associated amenities and parking.

Proposed access to the development is existing and provided at the following locations:

- One full-movement access onto Dynamic Drive (referred to as Access A). This access is existing, shared, and currently serves a variety of adjacent office or medical office buildings.
- One three-quarter movement access onto Research Parkway (referred to as Access B). This access is also existing, shared, and services the same office buildings described for Access A, including City Fire Station 19.

For purposes of this study, it is anticipated that development construction would be completed by end of Year 2024.

A conceptual site plan, as prepared by Humphreys & Partners Architects, L.P., is shown on Figure 2. This plan is provided for illustrative purposes only.

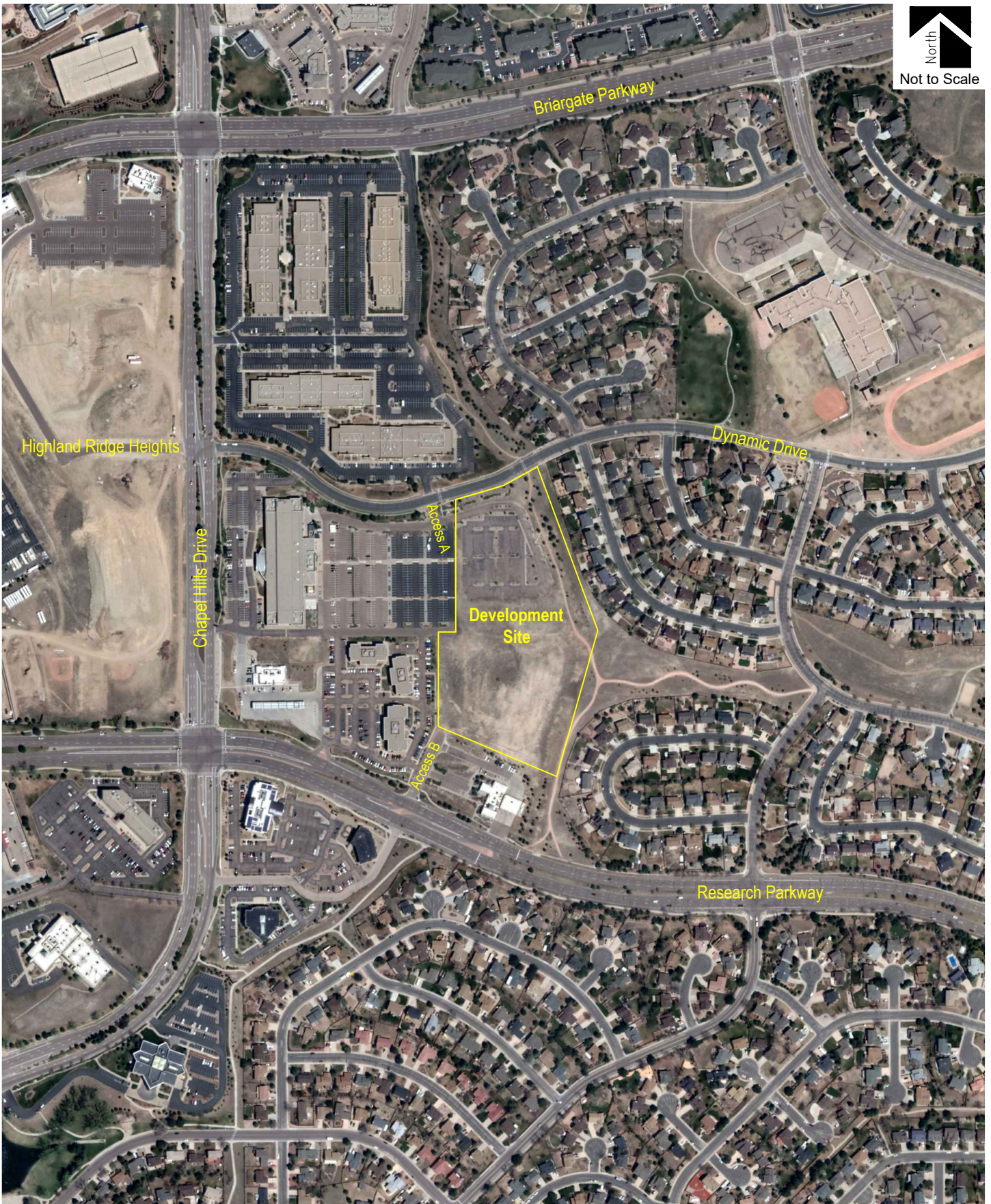

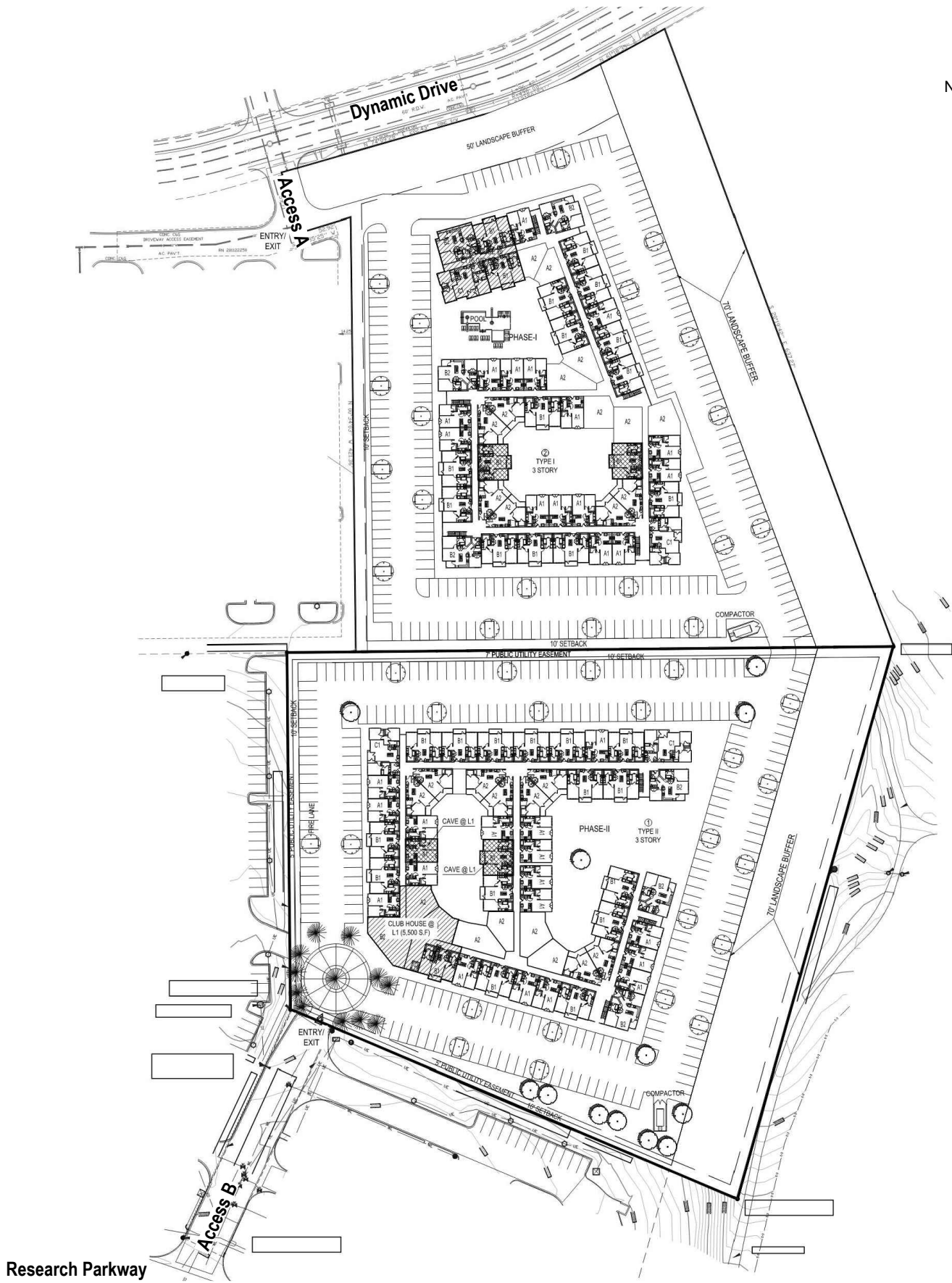

Research Parkway



Existing and Committed Surface Transportation Network

Within the study area, Research Parkway is the primary roadway that will accommodate traffic to and from the proposed development. Secondary roadways include Chapel Hills Drive and Dynamic Drive. A brief description of each roadway, based on the City's Major Thoroughfare Plan (MTP)¹ and the City's Traffic Criteria Manual², is provided below:

Research Parkway is an east-west principal arterial roadway having six through lanes (three lanes in each direction) with exclusive turn lanes at the intersections within the study area. Research Parkway provides a posted speed limit of 45 MPH.

Chapel Hills Drive is a north-south minor arterial roadway having six through lanes (three lanes in each direction) with exclusive turn lanes at the intersections within the study area. Chapel Hills Drive provides a posted speed limit of 35 MPH.

Dynamic Drive is an east-west roadway having two through lanes (one lane in each direction) with shared lanes at the intersections within the study area. Dynamic Drive is unclassified in City's MTP. However, per Sections 15.0 and 16.0 of City Traffic Criteria Manual, the roadway's estimated ROW width, and connection to Chapel Hills Drive, Dynamic Drive is assumed to be classified as a collector roadway and provides a posted speed limit of 25 MPH. Dynamic Drive ends at Chapel Hills Drive and continues west as Highland Ridge Heights.

The study intersection of Research Parkway and Chapel Hills Drive is signalized. All other study intersections operate under a stop-controlled condition. A stop-controlled intersection is defined as a roadway intersection where vehicle rights-of-way are controlled by one or more "STOP" signs.

Pursuant to the City's PlanCOS Comprehensive Plan³, no regional or specific improvements for the roadways described above are known to be planned or committed at this time. The study area roadways appear to be built to their ultimate cross-sections.

¹ Major Thoroughfare Plan, City of Colorado Springs, August 2011.

² Engineering Criteria Manual, Section III: Traffic Criteria Manual, City of Colorado Springs City Engineering, July 2010.

³ PlanCOS, City of Colorado Springs, January 2019.

II. Existing Traffic Conditions

Morning (AM) and afternoon (PM) peak hour traffic counts were collected at the Chapel Hills Drive intersections of Research Parkway and Dynamic Drive, as well as the existing site access intersections along Research Parkway and Dynamic Drive. Average daily traffic (ADT) volumes were collected over a 24-hour period on Research Parkway and Dynamic Drive. Counts were collected on Thursday December 9, 2021, with AM peak hour counts being collected during the period of 7:00 a.m. to 9:00 a.m. and PM peak hour counts being collected during the period of 4:00 p.m. to 6:00 p.m. The adjacent school (Mountain Ridge Middle School) was in full in-class session during this period of count collection.

The defined peak hour count duration is compliant to City standards for being the typical time when traffic on the adjacent street system is the highest and commonly used to identify the adequacy of the existing street right of way to accommodate any changes in trips generated caused from a proposed development.

The average daily count collection for Dynamic Drive shows the morning peak hour occurring at 7:00 a.m. with the afternoon peak hour occurring at 3:00 p.m. These peak hours correspond to the student class schedule of the adjacent middle school. The difference or change from the typical afternoon peak hour of adjacent street traffic occurrence, as earlier discussed, is likely caused by student dismissal from the school. To account for the peak hour volume difference and consideration of adjacent school traffic effect on operational analyses contained within this study, all collected peak hour turn movement counts for analyzed intersections along Dynamic Drive were increased by 20 percent to represent the difference between hourly traffic volumes during the 3:00 and 4:00 p.m. hours. No change was made to collected peak hour turn movement volumes along Chapel Hills Drive and Research Parkway since they had a daily peak hour volume at 7:00 a.m. and 4:00 p.m.

The adjusted (increased) counts and intersection geometry are shown on Figure 3.

No COVID pandemic adjustment to collected traffic volumes was performed since the date of collected count data is considered to adequately represent traffic volumes under normal conditions for purposes of this analysis.

Collected traffic count data is included for reference in Appendix A.

Existing signal timing parameters for Research Parkway and Chapel Hills Drive were obtained from City Staff and used throughout this study to the best extent possible in order to remain consistent with existing signal coordination plans. City signal timing information received is included for reference in Appendix A.

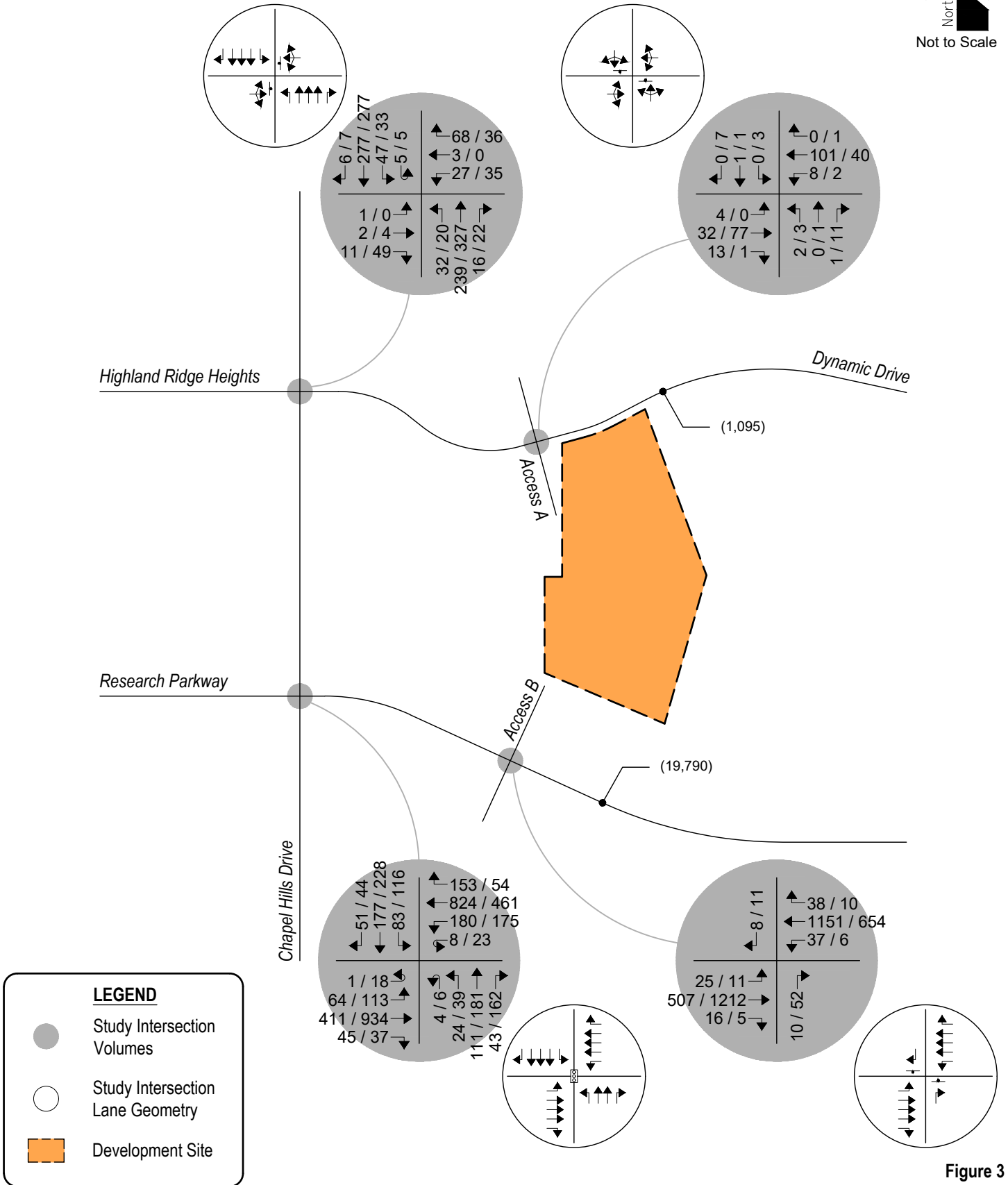

Figure 3
EXISTING TRAFFIC
Volumes & Intersection Geometry
AM / PM Peak Hour
(ADT) : Average Daily Traffic



The Signalized and Unsignalized Intersection Analysis techniques, as published in the Highway Capacity Manual (HCM) by the Transportation Research Board and as incorporated into the SYNCHRO computer program, were used to analyze the study intersections for existing traffic conditions. These nationally accepted techniques allow for the determination of intersection level of service (LOS) based on the congestion and delay of each traffic movement.

Level of service is a method of measurement used by transportation professionals to quantify a driver’s perception of travel conditions that include travel time, number of stops, and total amount of stopped delay experienced on a roadway network. The HCM categorizes level of service into a range from “A” which indicates little, if any, vehicle delay, to “F” which indicates a level of operation considered unacceptable to most drivers. These levels of service grades with brief descriptions of the operating condition, for unsignalized and signalized intersections, are included for reference in Appendix B and have been used throughout this study.

The level of service analyses results for existing conditions are summarized in Table 1.

Intersection capacity worksheets developed for this study are provided in Appendix C.

Table 1 – Intersection Capacity Analysis Summary – Existing Traffic

INTERSECTION LANE GROUPS	LEVEL OF SERVICE	
	AM PEAK HOUR	PM PEAK HOUR
Research Parkway / Chapel Hills Drive (Signalized)	B (18.1)	C (23.5)
Chapel Hills Drive / Dynamic Drive (Stop-Controlled)		
Eastbound Left, Through and Right	B	B
Westbound Left, Through and Right	B	B
Northbound Left	A	A
Southbound Left	A	A
Dynamic Drive / Access A (Stop-Controlled)		
Eastbound Left, Through and Right	A	A
Westbound Left, Through and Right	A	A
Northbound Left, Through and Right	A	A
Southbound Left, Through and Right	B	A
Research Parkway / Access B (Stop-Controlled)		
Eastbound Left	C	B
Westbound Left	A	A
Northbound Right	A	B
Southbound Right	C	B

Key: Signalized Intersection: Level of Service (Control Delay in sec/v eh)
 Stop-Controlled Intersection: Level of Service

Existing Traffic Analysis Results

Under existing conditions, operational analysis shows that the signalized intersection of Research Parkway with Chapel Hills Drive has overall operations at LOS B during the morning peak traffic hour and LOS C during the afternoon peak traffic hour.

The stop-controlled intersection of Chapel Hills Drive with Dynamic Drive has turning movement operations at or better than LOS B during both the morning and afternoon peak traffic hours.

The stop-controlled intersection of Dynamic Drive with Access A has turning movement operations at or better than LOS B during the morning peak traffic hour and LOS A during the afternoon peak traffic hour.

The stop-controlled intersection of Research Parkway with Access B has turning movement operations at or better than LOS C during the morning peak traffic hour and LOS B or better during the afternoon peak traffic hour.

III. Future Traffic Conditions Without Proposed Development

Background traffic is the traffic projected to be on area roadways without consideration of the proposed development. Background traffic includes traffic generated by development of vacant parcels in the area.

To account for projected increases in background traffic for Years 2024 and 2042, a compounded annual growth rate was determined using population growth estimates provided by the Pikes Peak Area Council of Governments' (PPACG) 2045 Long Range Transportation Plan⁴, as well as historical traffic data provided by the Colorado Department of Transportation's (CDOT) Traffic Count Database System (TCDS)⁵ along the adjacent segment of Research Parkway. PPACG's 2045 Long Range Transportation Plan anticipate a 20-year growth rate between one and two percent, while CDOT's TCDS anticipates average annual growth rates of approximately three percent. Therefore, in order to provide for a conservative analysis, a growth rate of three percent was applied to existing traffic volumes. This annual growth rate is also considered consistent with regional growth projections and the level of in-fill development expected within the area.

Pursuant to the non-committed area roadway improvements discussed in Section I, Year 2024 and Year 2042 background traffic conditions assume no roadway improvements to accommodate regional transportation demands. Year 2042 assumes existing signal timing parameters for Research Parkway and Chapel Hills Drive with optimized intersection splits in effort to better long-term intersection performance. This assumption provides for a conservative analysis.

Projected background traffic volumes and intersection geometry for Years 2024 and 2042 are shown on Figure 4 and Figure 5, respectively.

⁴ Moving Forward 2045: Pikes Peak Area Regional Transportation Plan, Pikes Peak Area Council of Governments, January 2020.

⁵ Transportation Data Management System, MS2, 2021.

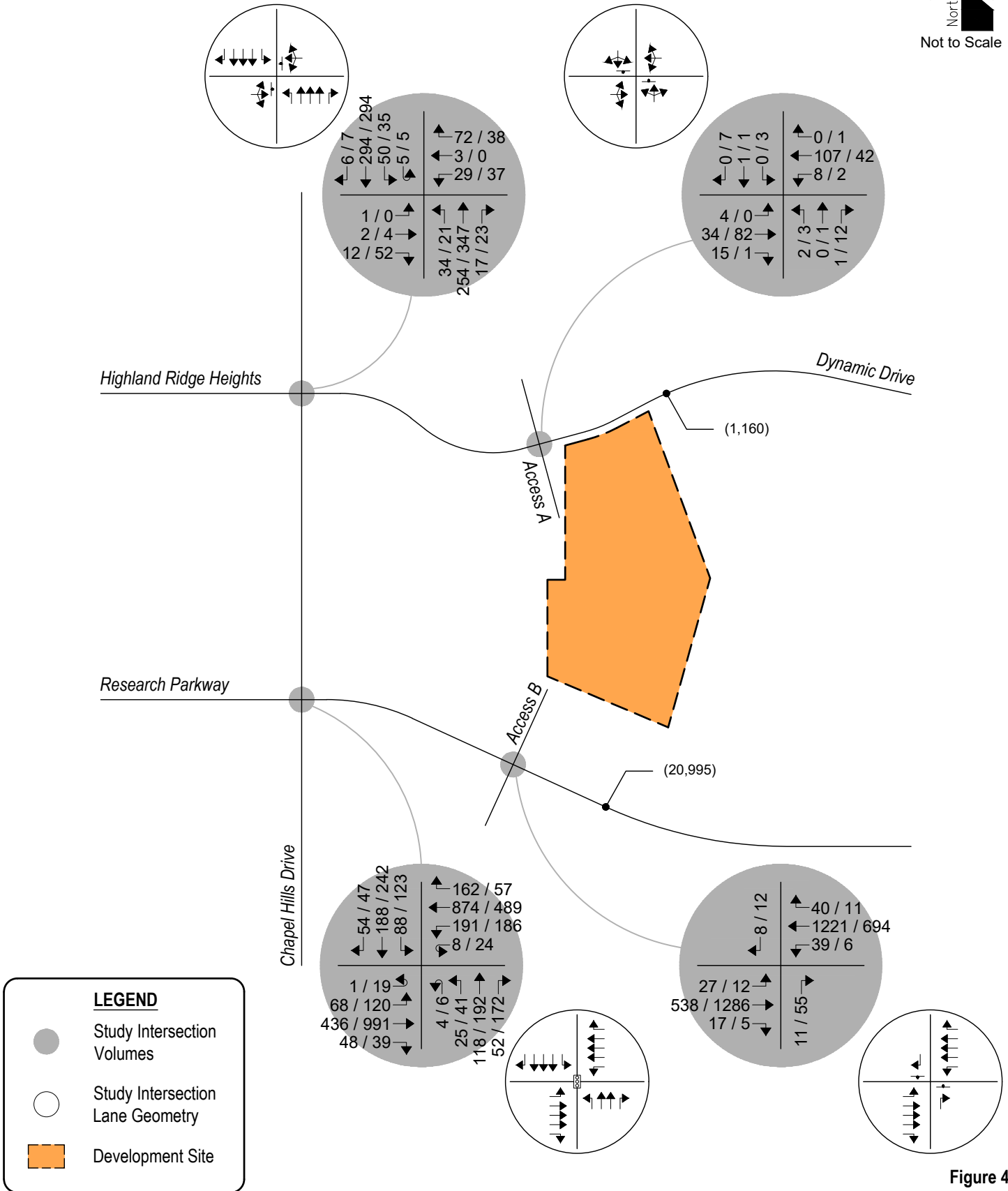

Figure 4
BACKGROUND TRAFFIC - YEAR 2024
 Volumes & Intersection Geometry
 AM / PM Peak Hour
 (ADT) : Average Daily Traffic



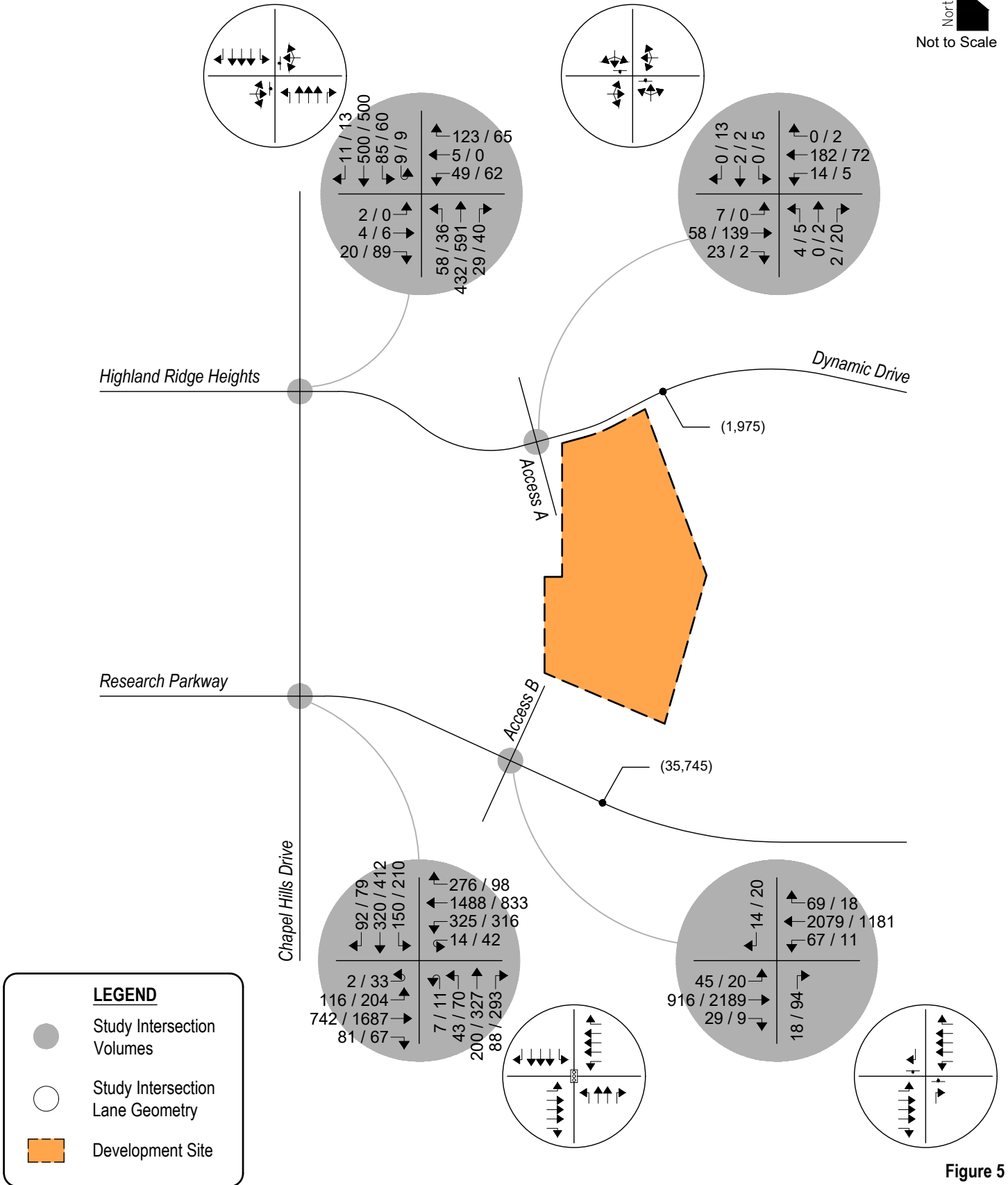

Figure 5
BACKGROUND TRAFFIC - YEAR 2042
Volumes & Intersection Geometry
AM / PM Peak Hour
(ADT) : Average Daily Traffic



As with existing traffic conditions and continued inclusion of adjacent school traffic, the operations of study intersections were analyzed under background conditions, without the proposed development, using the SYNCHRO computer program.

Background traffic level of service analysis results for Year 2024 are listed in Table 2. Year 2042 operational results are summarized in Table 3.

Definitions of levels of service are given in Appendix B. Intersection capacity worksheets are provided in Appendix C.

Table 2 – Intersection Capacity Analysis Summary – Background Traffic – Year 2024

INTERSECTION LANE GROUPS	LEVEL OF SERVICE	
	AM PEAK HOUR	PM PEAK HOUR
Research Parkway / Chapel Hills Drive (Signalized)	B (18.3)	C (24.4)
Chapel Hills Drive / Dynamic Drive (Stop-Controlled)		
Eastbound Left, Through and Right	B	B
Westbound Left, Through and Right	B	B
Northbound Left	A	A
Southbound Left	A	A
Dynamic Drive / Access A (Stop-Controlled)		
Eastbound Left, Through and Right	A	A
Westbound Left, Through and Right	A	A
Northbound Left, Through and Right	A	A
Southbound Left, Through and Right	B	A
Research Parkway / Access B (Stop-Controlled)		
Eastbound Left	C	B
Westbound Left	A	A
Northbound Right	A	B
Southbound Right	C	B

Key: Signalized Intersection: Level of Service (Control Delay in sec/veh)
Stop-Controlled Intersection: Level of Service

Background Traffic Analysis Results – Year 2024

Year 2024 background traffic analysis indicates that the signalized intersection of Research Parkway with Chapel Hills Drive experiences overall operations at LOS B during the morning peak traffic hour and LOS C during the afternoon peak traffic hour.

All stop-controlled intersections within the study area show turning movement operations at or better than LOS C during the morning peak traffic hour and LOS B or better during the afternoon peak traffic hour.

Table 3 – Intersection Capacity Analysis Summary – Background Traffic – Year 2042

INTERSECTION LANE GROUPS	LEVEL OF SERVICE	
	AM PEAK HOUR	PM PEAK HOUR
Research Parkway / Chapel Hills Drive (Signalized)	C (25.0)	D (43.0)
Chapel Hills Drive / Dynamic Drive (Stop-Controlled)		
Eastbound Left, Through and Right	B	B
Westbound Left, Through and Right	C	C
Northbound Left	B	B
Southbound Left	A	A
Dynamic Drive / Access A (Stop-Controlled)		
Eastbound Left, Through and Right	A	A
Westbound Left, Through and Right	A	A
Northbound Left, Through and Right	B	A
Southbound Left, Through and Right	B	A
Research Parkway / Access B (Stop-Controlled)		
Eastbound Left	F	C
Westbound Left	A	B
Northbound Right	B	C
Southbound Right	D	C

Key: Signalized Intersection: Level of Service (Control Delay in sec/veh)
 Stop-Controlled Intersection: Level of Service

Background Traffic Analysis Results – Year 2042

By Year 2042 and without the proposed development, the study intersection of Research Parkway with Chapel Hills Drive anticipates overall operations at LOS C during the morning peak traffic hour and LOS D during the afternoon peak traffic hour.

The stop-controlled intersection of Chapel Hills Drive with Dynamic Drive expects turning movement operations at or better than LOS C during both the morning and afternoon peak traffic hours.

The stop-controlled intersection of Dynamic Drive with Access A projects turning movement operations at or better than LOS B during the morning peak traffic hour and LOS A during the afternoon peak traffic hour.

The stop-controlled intersection of Research Parkway with Access B shows turning movement operations at or better than LOS D during the morning peak traffic hour and LOS C or better during the afternoon peak traffic hour. The exception includes the eastbound left turning movement which operates at LOS F during the morning peak traffic hour. The LOS F operation is attributed to the westbound through traffic volume along Research Parkway and the stop-controlled nature of the intersection.

It is emphasized that it is not uncommon for unsignalized movements to or from an arterial roadway, in urban areas, to operate with noticeable delays during peak traffic hours. It is, however, likely that turn movements will operate better than the results obtained with this HCM Two Way Stop Control (TWSC) level of service analysis would indicate, as the HCM analysis limitations may not accurately account for the effect of vehicle platooning and gaps caused by upstream signals. Upstream signal controls along Research parkway creates additional gaps in the traffic stream for turning movements at Access B which can provide mitigation to the LOS F operation projected during the morning peak traffic hour.

IV. Proposed Project Traffic

Trip Generation

Standard traffic generation characteristics compiled by the Institute of Transportation Engineers (ITE) in their report entitled Trip Generation Manual, 10th Edition, were applied to the proposed land use in order to estimate average daily traffic (ADT), AM Peak Hour, and PM Peak Hour vehicle trips. A vehicle trip is defined as a one-way vehicle movement from a point of origin to a point of destination.

The ITE land use code 221 (Multifamily Housing (Mid-Rise)) was used for estimating trip generation because of its best fit to the proposed land use description.

Trip generation rates used in this study are presented in Table 4.

Table 4 – Trip Generation Rates

ITE CODE	LAND USE	UNIT	TRIP GENERATION RATES						
			24 HOUR	AM PEAK HOUR			PM PEAK HOUR		
				ENTER	EXIT	TOTAL	ENTER	EXIT	TOTAL
221	Multifamily Housing (Mid-Rise)	DU	5.44	0.09	0.27	0.36	0.27	0.17	0.44

Key: DU = Dwelling Units.

Note: All data and calculations above are subject to being rounded to nearest value.

Table 5 illustrates projected ADT, AM Peak Hour, and PM Peak Hour traffic volumes likely generated by the proposed development upon build-out.

Table 5 – Trip Generation Summary

ITE CODE	LAND USE	SIZE	DU	TOTAL TRIPS GENERATED						
				24 HOUR	AM PEAK HOUR			PM PEAK HOUR		
					ENTER	EXIT	TOTAL	ENTER	EXIT	TOTAL
221	Multifamily Housing (Mid-Rise)	300	DU	1,632	28	80	108	81	51	132
<i>Total:</i>				1,632	28	80	108	81	51	132

Note: All data and calculations above are subject to being rounded to nearest value.

Upon build-out, Table 5 illustrates that the proposed development has the potential to generate approximately 1,632 daily trips with 108 of those occurring during the morning peak hour and 132 during the afternoon peak hour.

Adjustments to Trip Generation Rates

A development of this type is not likely to attract trips from within area land uses nor pass-by or diverted link trips from the adjacent roadway system, therefore no trip reduction was taken in this analysis.

Trip Distribution

The overall directional distribution of site-generated traffic was determined based on the location of development site within the City, proposed and existing area land uses, allowed turning movements, available roadway network, and in reference to historical traffic count data provided by CDOT's TCDS.

The northbound right turn percentage designated at Access A is likely higher than that to be experienced upon actual development use. However, use of the designated percentage remains in this study in effort to represent a conservative analysis of roadway and intersection operations.

Overall trip distribution patterns for the development are shown on Figure 6.

Trip Assignment

Trip assignment is how generated and distributed vehicle trips are expected to be loaded onto the available roadway network.

Applying trip distribution patterns to site-generated traffic provides the overall site-generated trip assignments shown on Figure 6.

Given the three-quarter nature of the existing Access B intersection with Research Parkway, vehicle trips returning to the east are likely to perform a U-turn movement at the first available intersection or median break. Specifically, it is assumed that vehicles leaving the development site at Research Parkway with a destination to the east are likely to make the first legal turnaround possible. This is expected to be accomplished at the Chapel Hills Driver intersection by utilizing the westbound left turn lane for the U-turn movement.

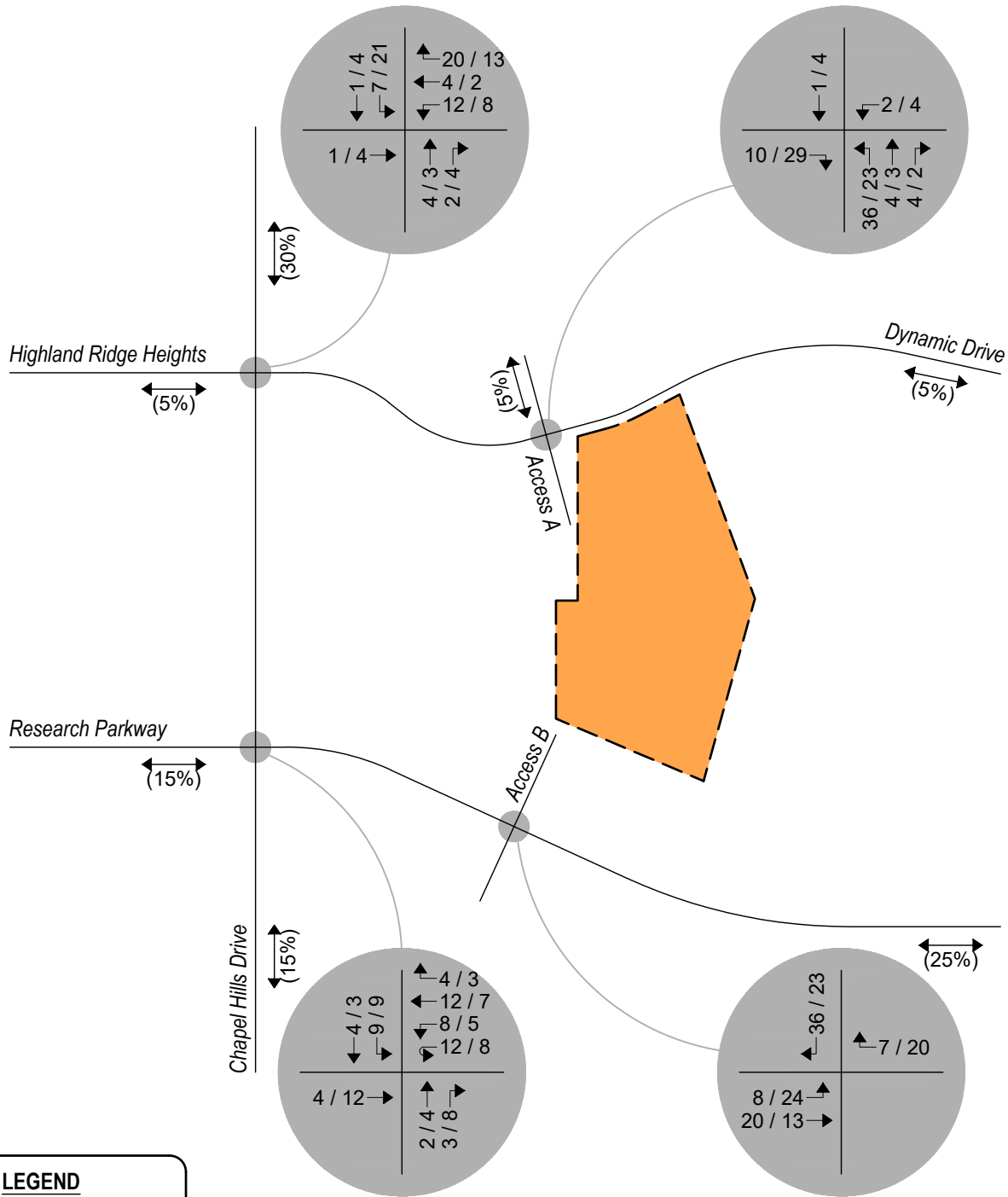

LEGEND

- Study Intersection Volumes
- Development Site

Figure 6
SITE DEVELOPMENT DISTRIBUTION
(%) : Overall
SITE-GENERATED
AM / PM Peak Hour

V. Future Traffic Conditions With Proposed Developments

Site-generated traffic was added to background traffic projections for Years 2024 and 2042 to develop total traffic projections. For analysis purposes, it was assumed that development construction would be completed by end of Year 2024.

Pursuant to area roadway improvement discussions provided in Section III, Year 2024 and Year 2042 total traffic conditions assume no roadway improvements to accommodate regional transportation demands. Roadway improvements associated with site development are expected to be limited to site access and frontage as required by the governing agency.

Projected Year 2024 total traffic volumes and intersection geometry are shown in Figure 7.

Figure 8 shows projected total traffic volumes and intersection geometry for Year 2042.

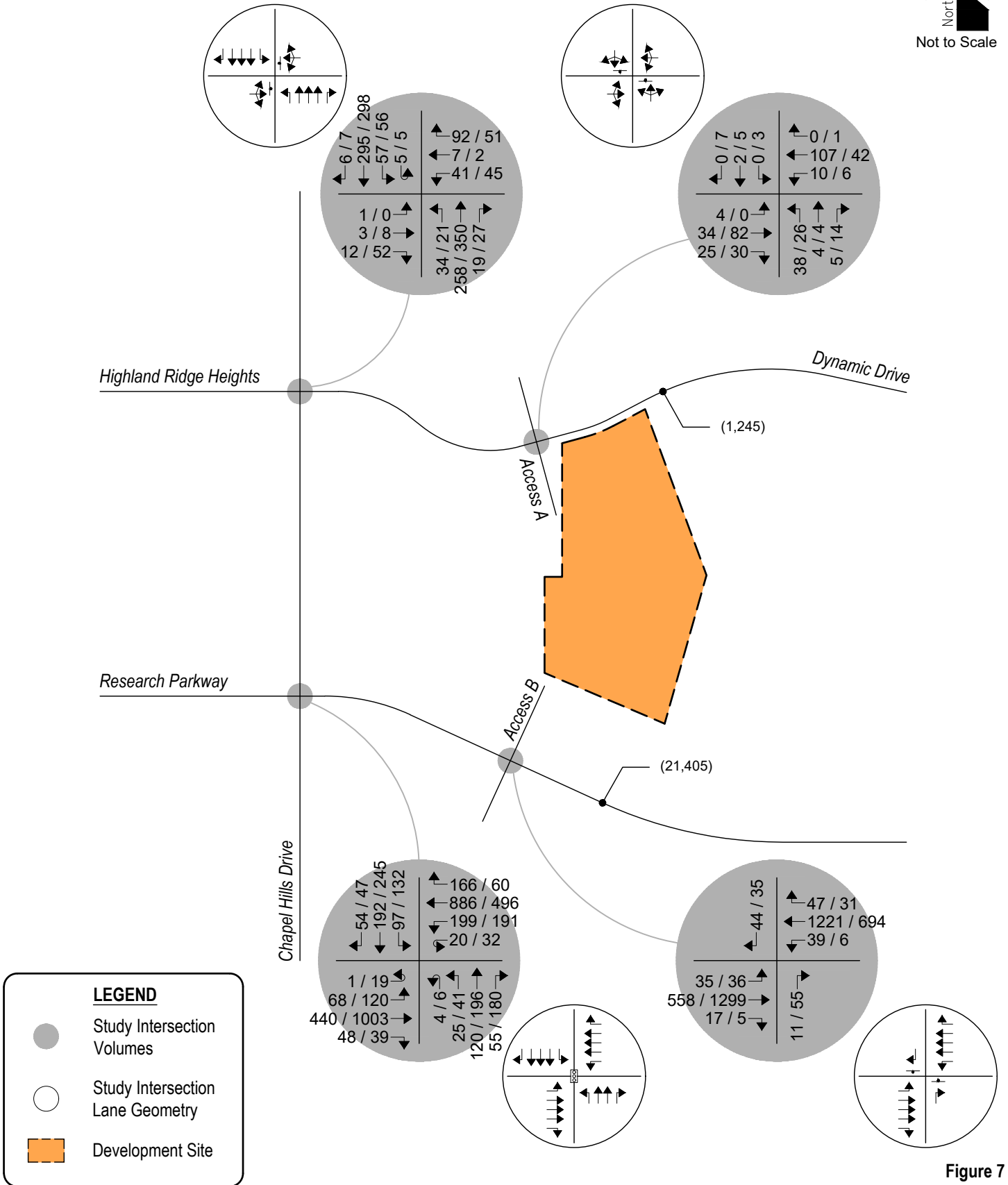
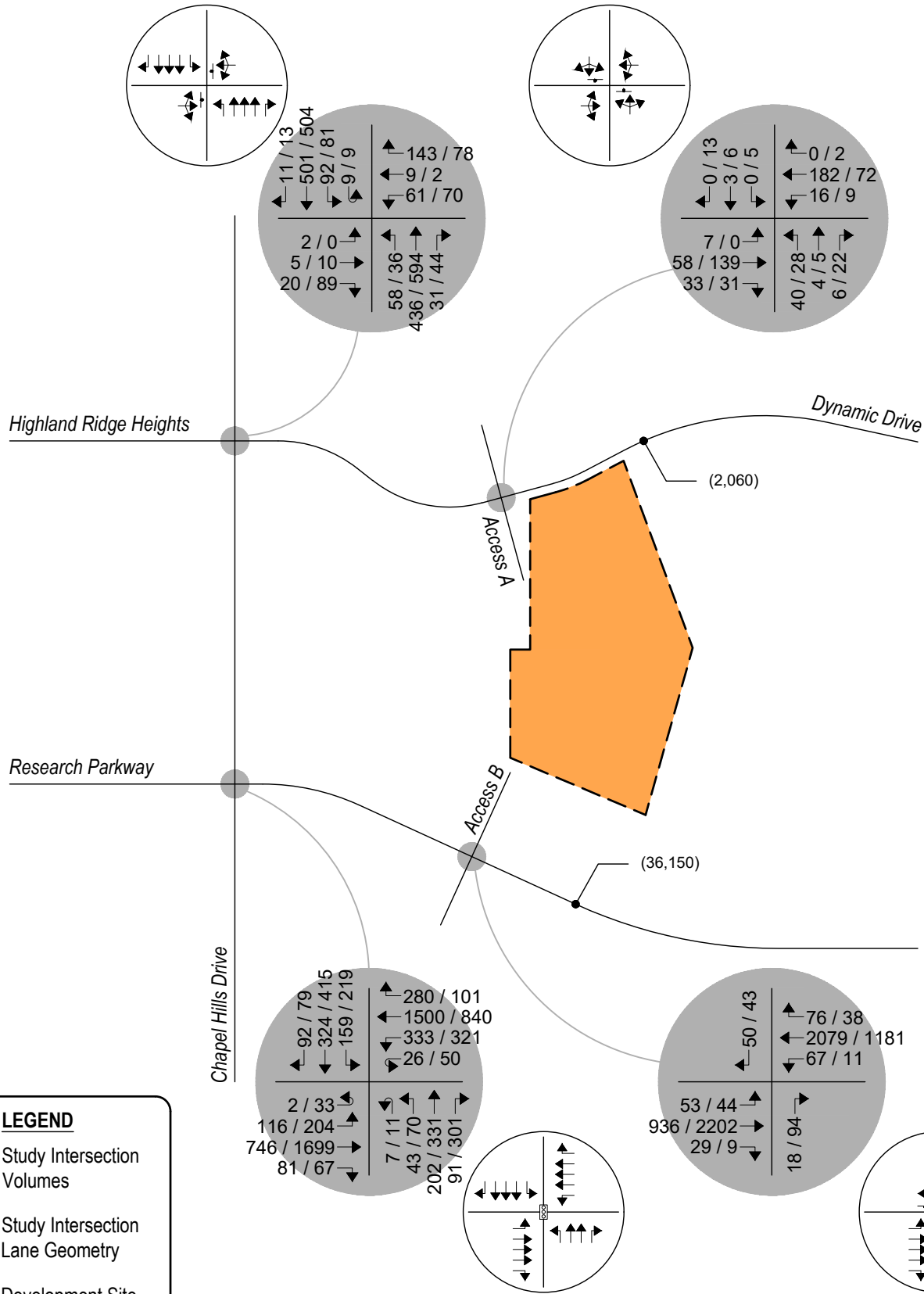

Figure 7
TOTAL TRAFFIC - YEAR 2024
 Volumes & Intersection Geometry
 AM / PM Peak Hour
 (ADT) : Average Daily Traffic



LEGEND

- Study Intersection Volumes
- Study Intersection Lane Geometry
- Development Site

Figure 8
TOTAL TRAFFIC - YEAR 2042
 Volumes & Intersection Geometry
 AM / PM Peak Hour
 (ADT) : Average Daily Traffic

VI. Project Impacts

The analyses and procedures described in this study were performed in accordance with the Highway Capacity Manual (HCM) and are based upon the worst-case conditions that occur during a typical weekday upon build-out of site development and analyzed land uses. Therefore, study intersections are likely to operate with traffic conditions better than those described within this study, which represent the peak hours of weekday operations only.

Peak Hour Intersection Levels of Service

As with background traffic, the operations of the study intersections were analyzed under projected total traffic conditions using the SYNCHRO computer program. Total traffic level of service analysis results for Years 2024 and 2042 are summarized in Table 6 and Table 7, respectively.

Definitions of levels of service are given in Appendix B. Intersection capacity worksheets are provided in Appendix C.

Table 6 – Intersection Capacity Analysis Summary – Total Traffic – Year 2024

INTERSECTION LANE GROUPS	LEVEL OF SERVICE	
	AM PEAK HOUR	PM PEAK HOUR
Research Parkway / Chapel Hills Drive (Signalized)	B (18.6)	C (25.3)
Chapel Hills Drive / Dynamic Drive (Stop-Controlled)		
Eastbound Left, Through and Right	B	B
Westbound Left, Through and Right	B	B
Northbound Left	A	A
Southbound Left	A	A
Dynamic Drive / Access A (Stop-Controlled)		
Eastbound Left, Through and Right	A	A
Westbound Left, Through and Right	A	A
Northbound Left, Through and Right	B	A
Southbound Left, Through and Right	B	A
Research Parkway / Access B (Stop-Controlled)		
Eastbound Left	C	B
Westbound Left	A	A
Northbound Right	A	B
Southbound Right	C	B

Key: Signalized Intersection: Level of Service (Control Delay in sec/veh)
 Stop-Controlled Intersection: Level of Service

Table 7 – Intersection Capacity Analysis Summary – Total Traffic – Year 2042

INTERSECTION LANE GROUPS	LEVEL OF SERVICE	
	AM PEAK HOUR	PM PEAK HOUR
Research Parkway / Chapel Hills Drive (Signalized)	C (25.6)	D (44.9)
Chapel Hills Drive / Dynamic Drive (Stop-Controlled)		
Eastbound Left, Through and Right	C	B
Westbound Left, Through and Right	C	C
Northbound Left	B	B
Southbound Left	A	A
Dynamic Drive / Access A (Stop-Controlled)		
Eastbound Left, Through and Right	A	A
Westbound Left, Through and Right	A	A
Northbound Left, Through and Right	B	B
Southbound Left, Through and Right	B	A
Research Parkway / Access B (Stop-Controlled)		
Eastbound Left	F	C
Westbound Left	A	B
Northbound Right	B	C
Southbound Right	E	C

Key: Signalized Intersection: Level of Service (Control Delay in sec/veh)
 Stop-Controlled Intersection: Level of Service

Total Traffic Analysis Results Upon Development Build-Out

Table 7 illustrates how, by Year 2042 and upon development build-out, the signalized intersection of Research Parkway with Chapel Hills Drive anticipates overall operations at LOS C during the morning peak traffic hour and LOS D during the afternoon peak traffic hour.

The stop-controlled intersection of Chapel Hills Drive with Dynamic Drive expects turning movement operations at or better than LOS C during both the morning and afternoon peak traffic hours.

The stop-controlled intersection of Dynamic Drive with Access A projects turning movement operations at or better than LOS B during both the morning and afternoon peak traffic hours.

The stop-controlled intersection of Research Parkway with Access B indicates turning movement operations at or better than LOS B during the morning peak traffic hour and LOS C or better during the afternoon peak traffic hour. Exceptions include the eastbound left and southbound right turning movements which operate at LOS F and E, respectively, during the morning and afternoon peak traffic hours. The LOS F and E operations are attributed to the westbound through traffic volume along Research Parkway and the stop-controlled nature of the intersection.

Again emphasized, it is not uncommon for unsignalized movements to or from an arterial roadway, in urban areas, to operate with noticeable delays during peak traffic hours. However, it is highly probable that turn movements will operate better than the results obtained with this HCM Two Way Stop Control (TWSC) level of service analysis would indicate, as the HCM analysis limitation may not accurately account for the effect of vehicle platooning and gaps caused by upstream signals. Upstream signal controls along Research parkway can create additional gaps in the traffic stream for turning movements at Access B which can provide mitigation to the LOS F operation during the morning peak traffic hour as projected in this study.

Queue Length Analysis

Queue lengths for the existing site access intersections with Research Parkway and Dynamic Drive were analyzed using Year 2042 total traffic conditions. The analysis yields estimate of 95th percentile queue lengths, which have only a five percent probability of being exceeded during the analysis time period. Queue lengths were modeled and are included with the Synchro worksheets in Appendix C.

No significant queue at the existing site accesses were indicated. The greatest on-site queue length anticipated occurs at Access B during the morning peak hour. The queue length is approximately four vehicles for the eastbound left turning movement along Research Parkway.

An evaluation of the existing eastbound left turn lane against the anticipated 95th percentile queue indicates that the existing turn lane is able to accommodate projected vehicle queuing.

VII. Conclusion

This traffic impact study addressed the capacity, geometric, and control requirements associated with the development entitled Allaso Briargate. This proposed development consists of a multifamily residential community. The development is located near the southeast corner of Chapel Hills Drive and Dynamic Drive in Colorado Springs, Colorado.

This traffic impact study was revised to address neighborhood comments received during meeting conducted on February 3, 2022, and City review comments dated February 28, 2022, concerning analysis of Dynamic Drive and Lexington Drive intersection, inclusion of adjacent school (Mountain Ridge Middle School) traffic within this study, collected traffic counts adjustments for pandemic, and clarification of site access traffic distribution.

The study area examined in this analysis encompassed Chapel Hills Drive from Research Parkway north to Dynamic Drive and includes the existing site access intersections along Research Parkway and Dynamic Drive.

Analysis was conducted for critical AM Peak Hour and PM Peak Hour traffic operations for existing traffic conditions, Year 2024 and Year 2042 background traffic conditions, and Year 2024 and Year 2042 total traffic conditions.

Analysis of existing traffic conditions indicates that all study intersections within the study area have turning movement operations at or better than LOS C during both the morning and afternoon peak traffic hours.

Without the proposed development, Year 2024 background operational analysis shows that the study intersections continue to have operations at or better than LOS C during both the morning and afternoon peak traffic hours.

By Year 2042 and without the proposed development, the study intersection of Research Parkway with Chapel Hills Drive anticipates overall operations at LOS C during the morning peak traffic hour and LOS D during the afternoon peak traffic hour. All stop-controlled intersections are expected to have turning movement operations at or better than LOS C during both the morning and afternoon peak traffic hour. The exception includes the eastbound left turning movement at Research Parkway and Access B, which operates at LOS F during the morning peak traffic hour. The LOS F operation is attributed to the westbound through traffic volume along Research Parkway and the stop-controlled nature of the intersection.

Analysis of future traffic conditions indicates that the addition of site-generated traffic is expected to create minimal negative impact to traffic operations for the existing and surrounding roadway system. With all conservative assumptions defined in this analysis, the study intersections are projected to operate at future levels of service comparable to Year 2042 background traffic conditions. Existing site access intersections have long-term operations at LOS C or better during peak traffic periods and upon build-out. Exceptions include the eastbound left and southbound right turning movements at Research Parkway and Access B, which operate at LOS F and E, respectively, during the morning and afternoon peak traffic hours. The LOS F and E operations are attributed to the westbound through traffic volume along Research Parkway and the stop-controlled nature of the intersection.

APPENDIX A

**Traffic Count Data
Signal Timing Information**



(303) 216-2439
www.alltrafficdata.net

Location: 1 CHAPEL HILLS DR & DYNAMIC DR AM

Date: Thursday, December 9, 2021

Peak Hour: 07:30 AM - 08:30 AM

Peak 15-Minutes: 07:45 AM - 08:00 AM

Peak Hour - All Vehicles

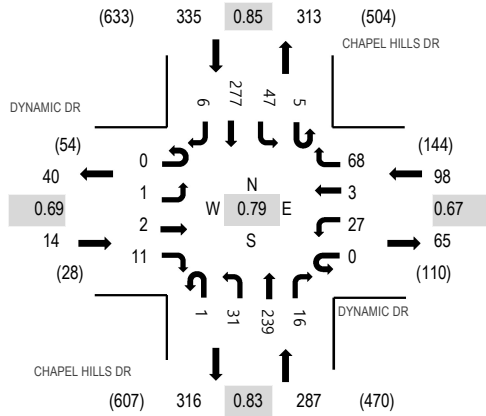

Peak Hour - Pedestrians/Bicycles on Crosswalk

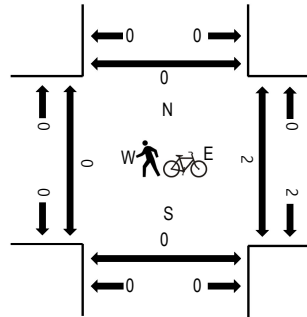

Note: Total study counts contained in parentheses.

Traffic Counts

Interval Start Time	DYNAMIC DR Eastbound				DYNAMIC DR Westbound				CHAPEL HILLS DR Northbound				CHAPEL HILLS DR Southbound				Total	Rolling Hour	Pedestrian Crossings			
	U-Turn	Left	Thru	Right	U-Turn	Left	Thru	Right	U-Turn	Left	Thru	Right	U-Turn	Left	Thru	Right			West	East	South	North
7:00 AM	0	1	0	1	0	3	0	9	0	1	24	2	1	3	48	1	94	626	0	0	0	0
7:15 AM	0	0	0	2	0	3	1	10	0	2	56	4	0	6	46	0	130	691	0	1	0	0
7:30 AM	0	0	0	0	0	13	0	24	0	4	51	5	0	9	61	2	169	734	0	2	0	0
7:45 AM	0	0	0	2	0	8	2	29	0	13	67	6	2	22	79	3	233	723	0	0	0	0
8:00 AM	0	1	1	3	0	4	1	9	1	8	48	3	3	10	66	1	159	649	0	0	0	0
8:15 AM	0	0	1	6	0	2	0	6	0	6	73	2	0	6	71	0	173		0	0	0	0
8:30 AM	0	0	0	2	0	6	0	6	0	3	40	3	1	9	88	0	158		0	1	0	0
8:45 AM	0	0	1	7	0	5	0	3	1	3	40	4	0	13	79	3	159		0	0	0	0
Count Total	0	2	3	23	0	44	4	96	2	40	399	29	7	78	538	10	1,275		0	4	0	0
Peak Hour	0	1	2	11	0	27	3	68	1	31	239	16	5	47	277	6	734		0	2	0	0



(303) 216-2439
www.alltrafficdata.net

Location: 1 CHAPEL HILLS DR & DYNAMIC DR PM

Date: Thursday, December 9, 2021

Peak Hour: 04:30 PM - 05:30 PM

Peak 15-Minutes: 04:45 PM - 05:00 PM

Peak Hour - All Vehicles

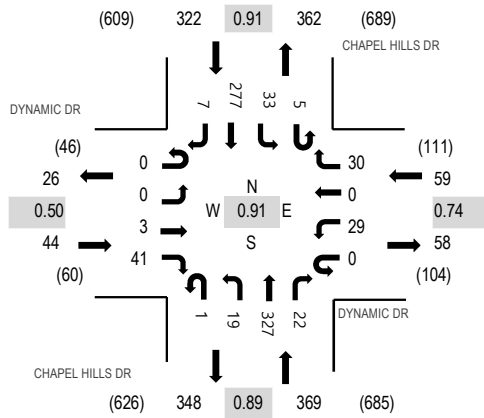

Peak Hour - Pedestrians/Bicycles on Crosswalk

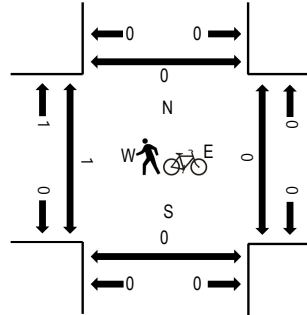

Note: Total study counts contained in parentheses.

Traffic Counts

Interval Start Time	DYNAMIC DR Eastbound				DYNAMIC DR Westbound				CHAPEL HILLS DR Northbound				CHAPEL HILLS DR Southbound				Total	Rolling Hour	Pedestrian Crossings			
	U-Turn	Left	Thru	Right	U-Turn	Left	Thru	Right	U-Turn	Left	Thru	Right	U-Turn	Left	Thru	Right			West	East	South	North
4:00 PM	0	0	0	3	0	5	2	1	0	3	70	1	1	9	69	0	164	756	0	1	0	0
4:15 PM	0	0	0	6	0	2	1	6	0	0	79	2	0	10	74	1	181	793	0	0	0	0
4:30 PM	0	0	0	8	0	9	0	5	1	2	73	3	1	12	78	2	194	794	0	0	0	0
4:45 PM	0	0	0	5	0	5	0	4	0	6	91	8	1	7	90	0	217	766	0	0	0	0
5:00 PM	0	0	3	19	0	10	0	13	0	6	80	5	2	8	54	1	201	709	1	0	0	0
5:15 PM	0	0	0	9	0	5	0	8	0	5	83	6	1	6	55	4	182		0	0	0	0
5:30 PM	0	0	0	5	0	7	0	17	0	3	75	4	0	5	47	3	166		0	0	0	0
5:45 PM	0	0	0	2	0	3	0	8	0	3	70	6	0	9	55	4	160		0	0	0	0
Count Total	0	0	3	57	0	46	3	62	1	28	621	35	6	66	522	15	1,465		1	1	0	0
Peak Hour	0	0	3	41	0	29	0	30	1	19	327	22	5	33	277	7	794		1	0	0	0



(303) 216-2439
www.alltrafficdata.net

Location: 2 CHAPEL HILLS DR & RESEARCH PKWY AM

Date: Thursday, December 9, 2021

Peak Hour: 07:30 AM - 08:30 AM

Peak 15-Minutes: 07:45 AM - 08:00 AM

Peak Hour - All Vehicles

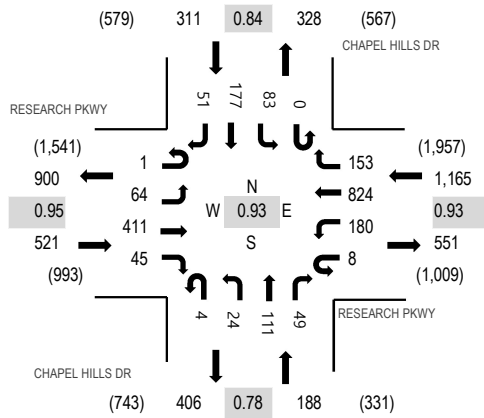

Note: Total study counts contained in parentheses.

Peak Hour - Pedestrians/Bicycles on Crosswalk

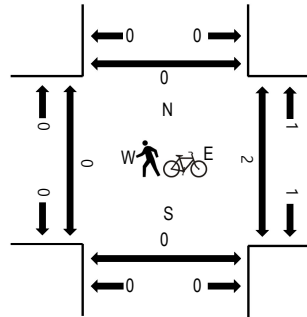

Traffic Counts

Interval Start Time	RESEARCH PKWY Eastbound				RESEARCH PKWY Westbound				CHAPEL HILLS DR Northbound				CHAPEL HILLS DR Southbound				Total	Rolling Hour	Pedestrian Crossings			
	U-Turn	Left	Thru	Right	U-Turn	Left	Thru	Right	U-Turn	Left	Thru	Right	U-Turn	Left	Thru	Right			West	East	South	North
7:00 AM	1	8	77	6	2	21	168	13	0	1	8	2	0	8	28	12	355	1,900	0	1	0	0
7:15 AM	1	17	85	8	0	18	186	29	0	2	24	10	0	9	27	13	429	2,088	0	0	0	0
7:30 AM	0	13	106	9	1	38	205	28	1	2	30	10	0	25	46	13	527	2,185	0	0	0	0
7:45 AM	0	18	105	15	0	45	219	50	0	8	29	15	0	23	51	11	589	2,107	0	1	0	0
8:00 AM	0	15	100	12	4	48	230	30	3	5	17	5	0	15	40	19	543	1,960	0	0	0	0
8:15 AM	1	18	100	9	3	49	170	45	0	9	35	19	0	20	40	8	526		0	0	0	0
8:30 AM	1	30	89	21	2	38	103	17	2	6	23	21	0	27	47	22	449		0	0	0	0
8:45 AM	1	24	94	9	4	62	110	19	1	3	27	13	0	15	49	11	442		0	0	1	0
Count Total	5	143	756	89	16	319	1,391	231	7	36	193	95	0	142	328	109	3,860		0	2	1	0
Peak Hour	1	64	411	45	8	180	824	153	4	24	111	49	0	83	177	51	2,185		0	1	0	0



(303) 216-2439
www.alltrafficdata.net

Location: 2 CHAPEL HILLS DR & RESEARCH PKWY PM

Date: Thursday, December 9, 2021

Peak Hour: 04:00 PM - 05:00 PM

Peak 15-Minutes: 04:00 PM - 04:15 PM

Peak Hour - All Vehicles

Peak Hour - Pedestrians/Bicycles on Crosswalk

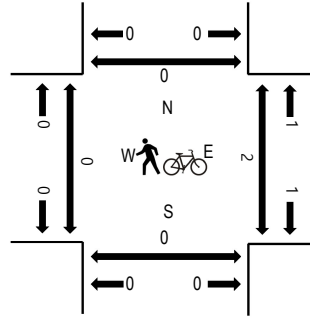
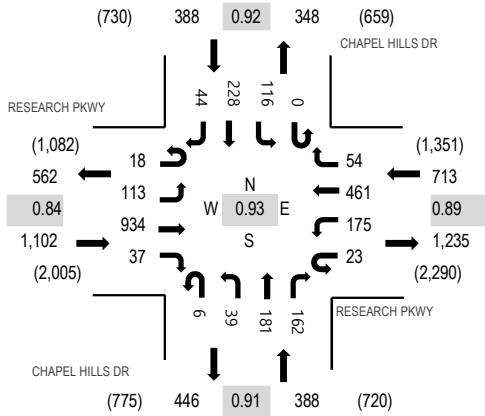

Note: Total study counts contained in parentheses.

Traffic Counts

Interval Start Time	RESEARCH PKWY Eastbound				RESEARCH PKWY Westbound				CHAPEL HILLS DR Northbound				CHAPEL HILLS DR Southbound				Total	Rolling Hour	Pedestrian Crossings			
	U-Turn	Left	Thru	Right	U-Turn	Left	Thru	Right	U-Turn	Left	Thru	Right	U-Turn	Left	Thru	Right			West	East	South	North
4:00 PM	5	25	260	8	6	51	133	11	1	8	48	47	0	23	62	11	699	2,591	0	1	0	0
4:15 PM	4	23	206	9	6	47	99	17	2	15	40	44	0	39	45	11	607	2,541	0	1	0	0
4:30 PM	6	32	278	12	5	31	115	11	1	11	40	37	0	25	56	10	670	2,508	0	0	0	0
4:45 PM	3	33	190	8	6	46	114	15	2	5	53	34	0	29	65	12	615	2,365	0	0	0	0
5:00 PM	5	29	257	5	6	38	106	8	5	16	43	44	0	41	37	9	649	2,215	0	0	1	0
5:15 PM	1	24	208	2	3	30	112	18	2	3	50	27	0	36	49	9	574		0	0	0	0
5:30 PM	2	15	189	4	4	24	113	13	1	8	40	26	0	25	43	20	527		0	0	0	0
5:45 PM	1	18	139	4	3	39	106	15	2	5	38	22	0	25	44	4	465		0	0	0	0
Count Total	27	199	1,727	52	39	306	898	108	16	71	352	281	0	243	401	86	4,806		0	2	1	0
Peak Hour	18	113	934	37	23	175	461	54	6	39	181	162	0	116	228	44	2,591		0	2	0	0



(303) 216-2439
www.alltrafficdata.net

Location: 3 SITE ACCESS & DYNAMIC DR AM

Date: Thursday, December 9, 2021

Peak Hour: 07:15 AM - 08:15 AM

Peak 15-Minutes: 07:45 AM - 08:00 AM

Peak Hour - All Vehicles

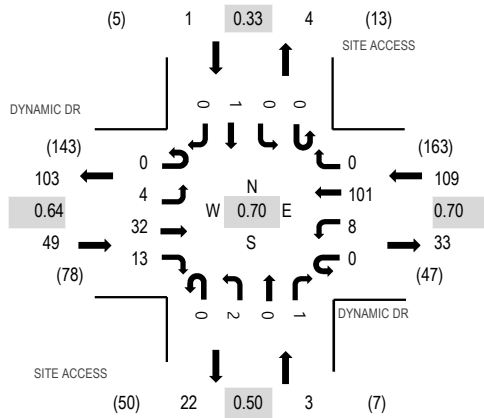

Note: Total study counts contained in parentheses.

Peak Hour - Pedestrians/Bicycles on Crosswalk

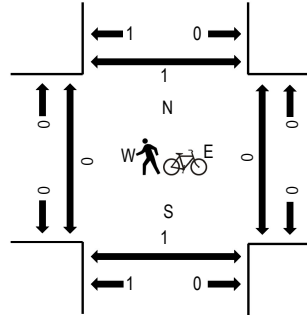

Traffic Counts

Interval Start Time	DYNAMIC DR Eastbound				DYNAMIC DR Westbound				SITE ACCESS Northbound				SITE ACCESS Southbound				Total	Rolling Hour	Pedestrian Crossings			
	U-Turn	Left	Thru	Right	U-Turn	Left	Thru	Right	U-Turn	Left	Thru	Right	U-Turn	Left	Thru	Right			West	East	South	North
7:00 AM	0	1	1	0	0	2	13	0	0	0	0	1	0	0	0	0	18	153	0	0	0	0
7:15 AM	0	0	5	1	0	1	14	0	0	0	0	1	0	0	1	0	23	162	0	0	0	1
7:30 AM	0	1	10	3	0	2	37	0	0	1	0	0	0	0	0	0	54	160	0	0	1	0
7:45 AM	0	1	14	4	0	0	39	0	0	0	0	0	0	0	0	0	58	133	0	0	0	0
8:00 AM	0	2	3	5	0	5	11	0	0	1	0	0	0	0	0	0	27	100	0	0	0	0
8:15 AM	0	0	4	1	0	5	10	0	0	0	0	1	0	0	0	0	21		0	0	0	0
8:30 AM	0	2	2	6	0	1	10	1	0	0	1	1	0	1	2	0	27		0	0	1	0
8:45 AM	0	2	3	7	0	3	7	2	0	0	0	0	0	0	1	0	25		0	0	0	1
Count Total	0	9	42	27	0	19	141	3	0	2	1	4	0	1	4	0	253		0	0	2	2
Peak Hour	0	4	32	13	0	8	101	0	0	2	0	1	0	0	1	0	162		0	0	1	1



(303) 216-2439
www.alltrafficdata.net

Location: 3 SITE ACCESS & DYNAMIC DR PM

Date: Thursday, December 9, 2021

Peak Hour: 04:30 PM - 05:30 PM

Peak 15-Minutes: 05:00 PM - 05:15 PM

Peak Hour - All Vehicles

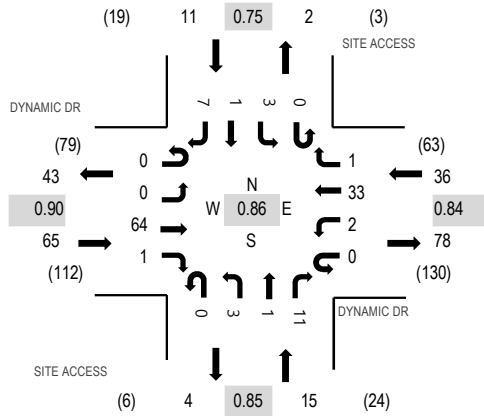

Peak Hour - Pedestrians/Bicycles on Crosswalk

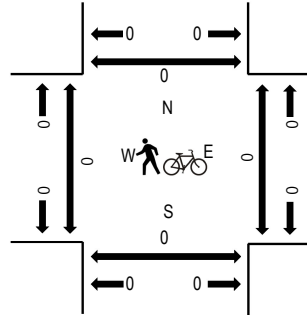

Note: Total study counts contained in parentheses.

Traffic Counts

Interval Start Time	DYNAMIC DR Eastbound				DYNAMIC DR Westbound				SITE ACCESS Northbound				SITE ACCESS Southbound				Total	Rolling Hour	Pedestrian Crossings				
	U-Turn	Left	Thru	Right	U-Turn	Left	Thru	Right	U-Turn	Left	Thru	Right	U-Turn	Left	Thru	Right			West	East	South	North	
4:00 PM	0	0	11	0	0	0	1	6	0	0	0	0	0	0	0	0	3	21	108	0	0	0	0
4:15 PM	0	0	12	0	0	0	1	7	0	0	0	1	0	1	0	1	1	24	124	0	0	0	0
4:30 PM	0	0	18	0	0	0	0	9	0	0	1	0	2	0	1	1	0	32	127	0	0	0	0
4:45 PM	0	0	16	0	0	0	1	8	0	0	0	0	4	0	1	0	1	31	116	0	0	0	0
5:00 PM	0	0	17	0	0	0	0	10	1	0	1	0	4	0	0	0	4	37	110	0	0	0	0
5:15 PM	0	0	13	1	0	0	1	6	0	0	1	1	1	0	1	0	2	27		0	0	0	0
5:30 PM	0	0	7	0	0	0	0	6	0	0	3	1	1	0	1	0	2	21		0	0	0	0
5:45 PM	0	0	17	0	0	0	0	6	0	0	1	0	1	0	0	0	0	25		0	0	0	0
Count Total	0	0	111	1	0	0	4	58	1	0	8	2	14	0	5	1	13	218		0	0	0	0
Peak Hour	0	0	64	1	0	0	2	33	1	0	3	1	11	0	3	1	7	127		0	0	0	0



(303) 216-2439
www.alltrafficdata.net

Location: 4 SITE ACCESS & RESEARCH PKWY AM

Date: Thursday, December 9, 2021

Peak Hour: 07:30 AM - 08:30 AM

Peak 15-Minutes: 07:45 AM - 08:00 AM

Peak Hour - All Vehicles

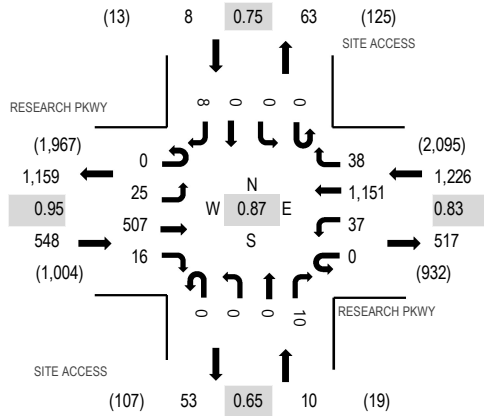

Peak Hour - Pedestrians/Bicycles on Crosswalk

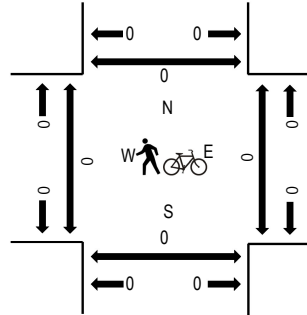

Note: Total study counts contained in parentheses.

Traffic Counts

Interval Start Time	RESEARCH PKWY Eastbound				RESEARCH PKWY Westbound				SITE ACCESS Northbound				SITE ACCESS Southbound				Total	Rolling Hour	Pedestrian Crossings			
	U-Turn	Left	Thru	Right	U-Turn	Left	Thru	Right	U-Turn	Left	Thru	Right	U-Turn	Left	Thru	Right			West	East	South	North
7:00 AM	0	7	81	3	0	7	198	10	0	0	0	0	0	0	0	0	306	1,617	0	0	0	0
7:15 AM	0	8	92	2	0	11	254	7	0	0	0	1	0	0	0	0	375	1,744	0	0	1	0
7:30 AM	0	7	129	2	0	12	263	5	0	0	0	3	0	0	0	0	422	1,792	0	0	0	0
7:45 AM	0	9	128	7	0	9	351	8	0	0	0	2	0	0	0	0	514	1,677	0	0	0	0
8:00 AM	0	4	119	4	0	10	282	10	0	0	0	1	0	0	0	3	433	1,514	0	0	0	0
8:15 AM	0	5	131	3	0	6	255	15	0	0	0	4	0	0	0	4	423		0	0	0	0
8:30 AM	0	7	123	5	0	6	157	4	0	0	0	3	0	0	0	2	307		0	0	3	0
8:45 AM	0	10	110	8	0	12	194	9	0	0	0	5	0	0	0	3	351		0	0	3	0
Count Total	0	57	913	34	0	73	1,954	68	0	0	0	19	0	0	0	13	3,131		0	0	7	0
Peak Hour	0	25	507	16	0	37	1,151	38	0	0	0	10	0	0	0	8	1,792		0	0	0	0



(303) 216-2439
www.alltrafficdata.net

Location: 4 SITE ACCESS & RESEARCH PKWY PM
Date: Thursday, December 9, 2021
Peak Hour: 04:00 PM - 05:00 PM
Peak 15-Minutes: 04:00 PM - 04:15 PM

Peak Hour - All Vehicles

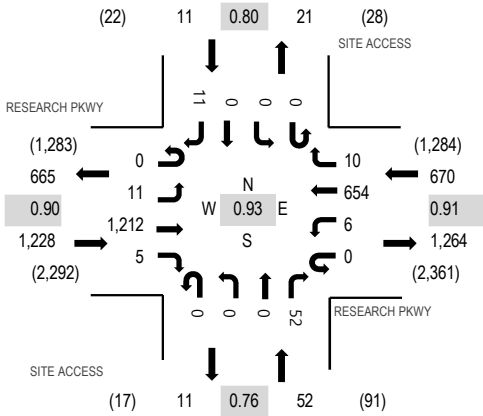

Peak Hour - Pedestrians/Bicycles on Crosswalk

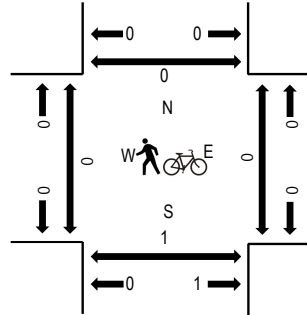

Note: Total study counts contained in parentheses.

Traffic Counts

Interval Start Time	RESEARCH PKWY Eastbound				RESEARCH PKWY Westbound				SITE ACCESS Northbound				SITE ACCESS Southbound				Total	Rolling Hour	Pedestrian Crossings			
	U-Turn	Left	Thru	Right	U-Turn	Left	Thru	Right	U-Turn	Left	Thru	Right	U-Turn	Left	Thru	Right			West	East	South	North
4:00 PM	0	0	325	4	0	1	180	3	0	0	0	15	0	0	0	2	530	1,961	0	0	0	0
4:15 PM	0	5	289	0	0	3	159	0	0	0	0	16	0	0	0	3	475	1,943	0	0	0	0
4:30 PM	0	1	336	0	0	1	149	4	0	0	0	13	0	0	0	2	506	1,927	0	0	0	0
4:45 PM	0	5	262	1	0	1	166	3	0	0	0	8	0	0	0	4	450	1,820	0	0	1	0
5:00 PM	0	2	346	0	0	1	139	1	0	0	0	18	0	0	0	5	512	1,728	0	0	1	0
5:15 PM	0	1	284	0	0	2	158	1	0	0	0	8	0	0	0	5	459		0	0	0	0
5:30 PM	0	1	236	1	0	0	150	1	0	0	0	9	0	0	0	1	399		0	0	0	0
5:45 PM	0	0	192	1	0	1	160	0	0	0	0	4	0	0	0	0	358		0	0	0	0
Count Total	0	15	2,270	7	0	10	1,261	13	0	0	0	91	0	0	0	22	3,689		0	0	2	0
Peak Hour	0	11	1,212	5	0	6	654	10	0	0	0	52	0	0	0	11	1,961		0	0	1	0

Date Start: 09-Dec-21
Site Code: 5
Station ID: 5
RESEARCH PKWY E.O. SITE ACCESS

Start Time	09-Dec-21 Thu	EB	WB	Total
12:00 AM		36	18	54
01:00		16	9	25
02:00		4	5	9
03:00		9	10	19
04:00		14	54	68
05:00		38	146	184
06:00		135	451	586
07:00		433	1106	1539
08:00		488	986	1474
09:00		440	612	1052
10:00		486	590	1076
11:00		669	676	1345
12:00 PM		746	648	1394
01:00		684	578	1262
02:00		810	608	1418
03:00		1116	748	1864
04:00		1257	661	1918
05:00		1114	618	1732
06:00		596	412	1008
07:00		421	220	641
08:00		367	179	546
09:00		243	101	344
10:00		97	55	152
11:00		56	24	80
Total		10275	9515	19790
Percent		51.9%	48.1%	
AM Peak	-	11:00	07:00	-
Vol.	-	669	1106	-
PM Peak	-	16:00	15:00	-
Vol.	-	1257	748	-
Grand Total		10275	9515	19790
Percent		51.9%	48.1%	
ADT		ADT 19,790		AADT 19,790

All Traffic Data Services
www.alltrafficdata.net

Date Start: 09-Dec-21
Site Code: 6
Station ID: 6
DYNAMIC DR E.O. SITE ACCESS

Start Time	09-Dec-21 Thu	EB	WB	Total
12:00 AM		2	1	3
01:00		0	0	0
02:00		0	0	0
03:00		2	0	2
04:00		2	3	5
05:00		4	6	10
06:00		14	23	37
07:00		38	107	145
08:00		15	45	60
09:00		30	28	58
10:00		22	20	42
11:00		36	32	68
12:00 PM		37	20	57
01:00		28	23	51
02:00		49	29	78
03:00		66	61	127
04:00		68	34	102
05:00		66	33	99
06:00		45	13	58
07:00		18	10	28
08:00		28	6	34
09:00		12	2	14
10:00		11	2	13
11:00		2	1	3
Total		595	499	1094
Percent		54.4%	45.6%	
AM Peak		07:00	07:00	07:00
Vol.		38	107	145
PM Peak		16:00	15:00	15:00
Vol.		68	61	127
Grand Total		595	499	1094
Percent		54.4%	45.6%	
ADT		ADT 1,094	ADT 1,094	AADT 1,094

Intersection 429 at Research Pkwy and Chapel Hills Dr - Timing table, page 1

	Phases											
	1	2	3	4	5	6	7	8	9	10	11	12
Page 1	1	2	3	4	5	6	7	8	9	10	11	12
Min Green	4	4	4	4	4	4	4	4	0	0	0	0
Passage Time I	2.0	5.0	2.0	3.0	2.0	5.0	2.0	3.0	0.0	0.0	0.0	0.0
Passage Time II	0.0	0.0	0.0	0.0	0.0	0.0	0.0	0.0	0.0	0.0	0.0	0.0
Max Green I	8	34	8	20	8	34	8	20	0	0	0	0
Max Green II	0	0	0	0	0	0	0	0	0	0	0	0
Yellow Clearance	3.0	4.5	3.0	4.5	3.0	4.5	3.0	4.5	0.0	0.0	0.0	0.0
Red Clearance	2.0	2.0	2.0	2.0	2.0	2.0	2.0	2.0	0.0	0.0	0.0	0.0
Added Initial	0.0	0.0	0.0	0.0	0.0	0.0	0.0	0.0	0.0	0.0	0.0	0.0
Max Added Initial	0	0	0	0	0	0	0	0	0	0	0	0
Time Before Reduction	0	0	0	0	0	0	0	0	0	0	0	0
Cars Before Reduction	0	0	0	0	0	0	0	0	0	0	0	0
Time To Reduce	0	0	0	0	0	0	0	0	0	0	0	0
Min Passage	0.0	0.0	0.0	0.0	0.0	0.0	0.0	0.0	0.0	0.0	0.0	0.0
Recall Green Time	0	0	0	0	0	0	0	0	0	0	0	0
Red Revert Time	0.0	0.0	0.0	0.0	0.0	0.0	0.0	0.0	0.0	0.0	0.0	0.0
Walk Time	0	7	0	7	0	7	0	7	0	0	0	0
Pedestrian Clearance	0	29	0	33	0	29	0	33	0	0	0	0
Handicap Walk	0	0	0	0	0	0	0	0	0	0	0	0
Handicap Ped Clearance	0	0	0	0	0	0	0	0	0	0	0	0
Research Pkwy	X	X			X	X						
Chapel Hills Dr			X	X			X	X				
Compass Direction	W	E	S	N	E	W	N	S				
Through, Turn or XPed	Left,prt	Thru	Left,prt	Thru	Left,prt	Thru	Left,prt	Thru				

Intersection 429 at Research Pkwy and Chapel Hills Dr - Sequence table, page 1

	Ring 1 Phases			Ring 2 Phases			Ring 3 Phases					
	1	2	3	4	5	6	7	8	9	10	11	12
Page 1	Vehicle				Vehicle							
State 1												
Barrier 1												
State 2		V & P				V & P						
Barrier 2	XXXXXXXXXXXXXXXXXXXX	XXXXXXXXXXXXXXXXXXXX	XXXXXXXXXXXX	XXXXXXXXXXXX	XXXXXXXXXXXXXXXXXXXX	XXXXXXXXXXXXXXXXXXXX	XXXXXXXXXXXX	XXXXXXXXXXXX	XXXXXXXXXXXX	XXXXXXXXXXXX	XXXXXXXXXXXX	XXXXXXXXXXXX
State 3			Vehicle				Vehicle					
Barrier 3												
State 4				V & P				V & P				
Barrier 4	XXXXXXXXXXXXXXXXXXXX	XXXXXXXXXXXXXXXXXXXX	XXXXXXXXXXXX	XXXXXXXXXXXX	XXXXXXXXXXXXXXXXXXXX	XXXXXXXXXXXXXXXXXXXX	XXXXXXXXXXXX	XXXXXXXXXXXX	XXXXXXXXXXXX	XXXXXXXXXXXX	XXXXXXXXXXXX	XXXXXXXXXXXX
State 5												
Barrier 5												
State 6												
Barrier 6												
State 7												
Barrier 7												
State 8												
Barrier 8												
State 9												
Barrier 9												
State 10												
Barrier 10												
State 11												
Barrier 11												
State 12												
Barrier 12												

Intersection 429 at Research Pkwy and Chapel Hills Dr - Phases control table, page 1

Page 1	Vehicle Phases	Ped Phases
	111 123456789012	111 123456789012
Min Recalls		Ped Recalls
Max Recalls	2 6	Handicap Ped Recalls
Recall If Maxed		Soft Ped Recalls
Dual Entry	4 8	Do Not Recall Ped
Do Not Skip		2 4 6 8
Simultaneous Gap Out		Allow Walk Reduction
Restricted Phases		Hold In Walk
Sequential Initial Timing		Allow Ped Re-service
Max Timer Starts For Call		Rest In Walk
Reduction Starts For Call		No
Red To Avoid Left Turn Trap	2 6	
Rest In Red	No	

Intersection 429 at Research Pkwy and Chapel Hills Dr - Spec signaling cntrl tbl, pg 1

Page 1									
Signaling Control 1					Signaling Control 2				
Function	Flashing permissive left turn	Timer 1	2.0	Function	Flashing permissive left turn	Timer 1	2.0	Function	Flashing permissive left turn
Operand	0	Timer 2	0.0	Operand	0	Timer 2	0.0	Operand	0
Trigger	Always enabled	Timer 3	0.0	Trigger	Always enabled	Timer 3	0.0	Trigger	Always enabled
	111	Output 1	25		111	Output 1	1		111
	123456789012	Output 2	34		123456789012	Output 2	35		123456789012
Phases 1	5	Output 3	41	Phases 1	1	Output 3	40	Phases 1	1
Phases 2	2	Output 4	1	Phases 2	6	Output 4	1	Phases 2	6
Overlaps 1				Overlaps 1				Overlaps 1	
Overlaps 2				Overlaps 2				Overlaps 2	
Signaling Control 3					Signaling Control 4				
Function	Flashing permissive left turn	Timer 1	2.0	Function	Flashing permissive left turn	Timer 1	2.0	Function	Flashing permissive left turn
Operand	0	Timer 2	0.0	Operand	0	Timer 2	0.0	Operand	0
Trigger	Always enabled	Timer 3	0.0	Trigger	Always enabled	Timer 3	0.0	Trigger	Always enabled
	111	Output 1	17		111	Output 1	9		111
	123456789012	Output 2	36		123456789012	Output 2	33		123456789012
Phases 1	3	Output 3	44	Phases 1	7	Output 3	43	Phases 1	7
Phases 2	8	Output 4	1	Phases 2	4	Output 4	1	Phases 2	4
Overlaps 1				Overlaps 1				Overlaps 1	
Overlaps 2				Overlaps 2				Overlaps 2	

Intersection 429 at Research Pkwy and Chapel Hills Dr - Coordination table, plans 1-2

Plan 1	111	Cycle Length	138										
Coordinated	123456789012	Offset 1	10		Phases	Splits	Alternate Mins	Alternate Passages	Alternate Maxes				
Phases	2 6	Offset 2	0		1	14	0	0.0	13				
Secondary		Offset 3	0		2	63	0	0.0	72				
Coordinated		Offset 4	0		3	15	0	0.0	14				
Phases		Relative Secondary Offset	0		4	46	0	0.0	51				
Extra Time		Permissive Period	Auto		5	14	0	0.0	13				
Phases		Max Cycle Addition	34		6	63	0	0.0	72				
Additional		Max Cycle Subtraction	34		7	15	0	0.0	14				
Max Recalls		Coord Actuated Period	0		8	46	0	0.0	51				
Units	Seconds	Top Of Cycle Green Point	End		9	0	0	0.0	0				
		Big Bang Preempt Recvry	No		10	0	0	0.0	0				
		Big Bang Ped Recovery	No		11	0	0	0.0	0				
		Min Lagging Left Split	0%		12	0	0	0.0	0				
Plan 2	111	Cycle Length	0										
Coordinated	123456789012	Offset 1	0		Phases	Splits	Alternate Mins	Alternate Passages	Alternate Maxes				
Phases		Offset 2	0		1	0	0	0.0	0				
Secondary		Offset 3	0		2	0	0	0.0	0				
Coordinated		Offset 4	0		3	0	0	0.0	0				
Phases		Relative Secondary Offset	0		4	0	0	0.0	0				
Extra Time		Permissive Period	Auto		5	0	0	0.0	0				
Phases		Max Cycle Addition	0		6	0	0	0.0	0				
Additional		Max Cycle Subtraction	0		7	0	0	0.0	0				
Max Recalls		Coord Actuated Period	0		8	0	0	0.0	0				
Units	Seconds	Top Of Cycle Green Point	End		9	0	0	0.0	0				
		Big Bang Preempt Recvry	No		10	0	0	0.0	0				
		Big Bang Ped Recovery	No		11	0	0	0.0	0				
		Min Lagging Left Split	0%		12	0	0	0.0	0				

Intersection 429 at Research Pkwy and Chapel Hills Dr - Schedule table, events 1-25

Event Num	Enabled	Event Type	Event Parameters			Start			Duration			Stop			Repetition		Priority
			Param 1	Param 2	Ofst #1	Mon	Day	Hour	Min	Sec	Minutes	Mon	Day	Repeat	Intervals		
1	Yes	Run Plan	Plan 1			1	1	06	00	00	735	12	31	Weekly	MTWTF	Low	
2																	
3																	
4																	
5																	
6																	
7																	
8																	
9																	
10																	
11																	
12																	
13																	
14																	
15																	
16																	
17																	
18																	
19																	
20																	
21																	
22																	
23																	
24																	
25																	

APPENDIX B

Level of Service Definitions

The following information can be found in the Highway Capacity Manual, Transportation Research Board, 2016: Chapter 19 – Signalized Intersections and Chapter 20 – Two-Way Stop Controlled Intersections.

Automobile Level of Service (LOS) for Signalized Intersections

Levels of service are defined to represent reasonable ranges in control delay.

LOS A

Describes operations with a control delay of 10 s/veh or less and a volume-to-capacity ratio no greater than 1.0. This level is typically assigned when the volume-to-capacity ratio is low and either progression is exceptionally favorable or the cycle length is very short. If it is due to favorable progression, most vehicles arrive during the green indication and travel through the intersection without stopping.

LOS B

Describes operations with control delay between 10 and 20 s/veh and a volume-to-capacity ratio no greater than 1.0. This level is typically assigned when the volume-to-capacity ratio is low and either progression is highly favorable or the cycle length is short. More vehicles stop than with LOS A.

LOS C

Describes operations with control delay between 20 and 35 s/veh and a volume-to-capacity ratio no greater than 1.0. This level is typically assigned when progression is favorable or the cycle length is moderate. Individual *cycle failures* (i.e., one or more queued vehicles are not able to depart as a result of insufficient capacity during the cycle) may begin to appear at this level. The number of vehicles stopping is significant, although many vehicles still pass through the intersection without stopping.

LOS D

Describes operations with control delay between 35 and 55 s/veh and a volume-to-capacity ratio no greater than 1.0. This level is typically assigned when the volume-to-capacity ratio is high and either progression is ineffective or the cycle length is long. Many vehicles stop and individual cycle failures are noticeable.

LOS E

Describes operations with control delay between 55 and 80 s/veh and a volume-to-capacity ratio no greater than 1.0. This level is typically assigned when the volume-to-capacity ratio is high, progression is unfavorable, and the cycle length is long. Individual cycle failures are frequent.

LOS F

Describes operations with control delay exceeding 80 s/veh or a volume-to-capacity ratio greater than 1.0. This level is typically assigned when the volume-to-capacity ratio is very high, progression is very poor, and the cycle length is long. Most cycles fail to clear the queue.

Level of Service (LOS) for Unsignalized TWSC Intersections

Level of Service (v/c ≤ 1.0)	Average Control Delay (s/veh)
A	0 - 10
B	> 10 - 15
C	> 15 - 25
D	> 25 - 35
E	> 35 - 50
F	> 50

APPENDIX C

Capacity Worksheets

Timings
1: Chapel Hills Drive & Research Parkway

Existing Traffic Conditions
AM Peak Hour

Lane Group	EBU	EBL	EBT	EBR	WBU	WBL	WBT	WBR	NBU	NBL	NBT	NBR
Lane Configurations												
Traffic Volume (vph)	1	64	411	45	8	180	824	153	4	24	111	43
Future Volume (vph)	1	64	411	45	8	180	824	153	4	24	111	43
Satd. Flow (prot)	0	1770	5085	1583	0	1770	5085	1583	0	1770	3539	1583
Flt Permitted		0.304				0.460				0.626		
Satd. Flow (perm)	0	566	5085	1583	0	857	5085	1583	0	1166	3539	1583
Satd. Flow (RTOR)				107				166				107
Lane Group Flow (vph)	0	71	447	49	0	205	896	166	0	30	121	47
Turn Type	custom	pm+pt	NA	Perm	custom	pm+pt	NA	Perm	custom	pm+pt	NA	Perm
Protected Phases		5	2			1	6			7	4	
Permitted Phases	5	2		2	1	6		6	7	4		4
Detector Phase	5	5	2	2	1	1	6	6	7	7	4	4
Switch Phase												
Minimum Initial (s)	4.0	4.0	4.0	4.0	4.0	4.0	4.0	4.0	4.0	4.0	4.0	4.0
Minimum Split (s)	9.0	9.0	10.5	10.5	9.0	9.0	10.5	10.5	9.0	9.0	10.5	10.5
Total Split (s)	14.0	14.0	63.0	63.0	14.0	14.0	63.0	63.0	15.0	15.0	46.0	46.0
Total Split (%)	10.1%	10.1%	45.7%	45.7%	10.1%	10.1%	45.7%	45.7%	10.9%	10.9%	33.3%	33.3%
Yellow Time (s)	3.0	3.0	4.5	4.5	3.0	3.0	4.5	4.5	3.0	3.0	4.5	4.5
All-Red Time (s)	2.0	2.0	2.0	2.0	2.0	2.0	2.0	2.0	2.0	2.0	2.0	2.0
Lost Time Adjust (s)		0.0	0.0	0.0		0.0	0.0	0.0		0.0	0.0	0.0
Total Lost Time (s)		5.0	6.5	6.5		5.0	6.5	6.5		5.0	6.5	6.5
Lead/Lag	Lead	Lead	Lag	Lag	Lead	Lead	Lag	Lag	Lead	Lead	Lag	Lag
Lead-Lag Optimize?	Yes	Yes	Yes	Yes	Yes	Yes	Yes	Yes	Yes	Yes	Yes	Yes
Recall Mode	None	None	C-Max	C-Max	None	None	C-Max	C-Max	None	None	None	None
Act Effct Green (s)		93.7	85.1	85.1		100.9	90.6	90.6		19.1	10.1	10.1
Actuated g/C Ratio		0.68	0.62	0.62		0.73	0.66	0.66		0.14	0.07	0.07
v/c Ratio		0.16	0.14	0.05		0.29	0.27	0.15		0.16	0.47	0.22
Control Delay		6.5	11.8	0.1		6.8	10.9	1.9		46.9	66.9	2.3
Queue Delay		0.0	0.0	0.0		0.0	0.0	0.0		0.0	0.0	0.0
Total Delay		6.5	11.8	0.1		6.8	10.9	1.9		46.9	66.9	2.3
LOS		A	B	A		A	B	A		D	E	A
Approach Delay			10.1				9.0					48.6
Approach LOS			B				A					D
Queue Length 50th (ft)		16	58	0		49	121	0		22	55	0
Queue Length 95th (ft)		32	86	0		82	159	29		50	88	0
Internal Link Dist (ft)			699				709				470	
Turn Bay Length (ft)		405		160		315		185		150		330
Base Capacity (vph)		470	3137	1017		697	3337	1096		226	1012	529
Starvation Cap Reductn		0	0	0		0	0	0		0	0	0
Spillback Cap Reductn		0	0	0		0	0	0		0	0	0
Storage Cap Reductn		0	0	0		0	0	0		0	0	0
Reduced v/c Ratio		0.15	0.14	0.05		0.29	0.27	0.15		0.13	0.12	0.09

Intersection Summary

Cycle Length: 138
 Actuated Cycle Length: 138
 Offset: 10 (7%), Referenced to phase 2:EBTL and 6:WBTL, Start of Green
 Natural Cycle: 45
 Control Type: Actuated-Coordinated

Timings
1: Chapel Hills Drive & Research Parkway

Existing Traffic Conditions
AM Peak Hour



Lane Group	SBL	SBT	SBR
Lane Configurations	↘	↑↑↑	↗
Traffic Volume (vph)	83	177	51
Future Volume (vph)	83	177	51
Satd. Flow (prot)	1770	5085	1583
Flt Permitted	0.498		
Satd. Flow (perm)	928	5085	1583
Satd. Flow (RTOR)			107
Lane Group Flow (vph)	90	192	55
Turn Type	pm+pt	NA	Perm
Protected Phases	3	8	
Permitted Phases	8		8
Detector Phase	3	8	8
Switch Phase			
Minimum Initial (s)	4.0	4.0	4.0
Minimum Split (s)	9.0	10.5	10.5
Total Split (s)	15.0	46.0	46.0
Total Split (%)	10.9%	33.3%	33.3%
Yellow Time (s)	3.0	4.5	4.5
All-Red Time (s)	2.0	2.0	2.0
Lost Time Adjust (s)	0.0	0.0	0.0
Total Lost Time (s)	5.0	6.5	6.5
Lead/Lag	Lead	Lag	Lag
Lead-Lag Optimize?	Yes	Yes	Yes
Recall Mode	None	None	None
Act Effct Green (s)	23.9	16.4	16.4
Actuated g/C Ratio	0.17	0.12	0.12
v/c Ratio	0.41	0.32	0.20
Control Delay	53.1	58.3	1.5
Queue Delay	0.0	0.0	0.0
Total Delay	53.1	58.3	1.5
LOS	D	E	A
Approach Delay		47.6	
Approach LOS		D	
Queue Length 50th (ft)	69	60	0
Queue Length 95th (ft)	119	88	0
Internal Link Dist (ft)		998	
Turn Bay Length (ft)	195		185
Base Capacity (vph)	222	1455	529
Starvation Cap Reductn	0	0	0
Spillback Cap Reductn	0	0	0
Storage Cap Reductn	0	0	0
Reduced v/c Ratio	0.41	0.13	0.10
Intersection Summary			

Timings
 1: Chapel Hills Drive & Research Parkway

Existing Traffic Conditions
 AM Peak Hour

Maximum v/c Ratio: 0.47

Intersection Signal Delay: 18.1









Intersection LOS: B

Intersection Capacity Utilization 46.6%

ICU Level of Service A

Analysis Period (min) 15

Splits and Phases: 1: Chapel Hills Drive & Research Parkway

 Ø1	 Ø2 (R)	 Ø3	 Ø4
14 s	63 s	15 s	46 s
 Ø5	 Ø6 (R)	 Ø7	 Ø8
14 s	63 s	15 s	46 s

HCM 6th TWSC
2: Chapel Hills Drive & Highland Ridge Heights/Dynamic Drive

Existing Traffic Conditions
AM Peak Hour

Intersection													
Int Delay, s/veh	2.7												
Movement	EBL	EBT	EBR	WBL	WBT	WBR	NBL	NBT	NBR	SBU	SBL	SBT	SBR
Lane Configurations		↕			↕		↕	↑↑↑	↕		↕	↑↑↑	↕
Traffic Vol, veh/h	1	2	11	27	3	68	32	239	16	5	47	277	6
Future Vol, veh/h	1	2	11	27	3	68	32	239	16	5	47	277	6
Conflicting Peds, #/hr	0	0	0	0	0	0	0	0	0	0	0	0	0
Sign Control	Stop	Stop	Stop	Stop	Stop	Stop	Free	Free	Free	Free	Free	Free	Free
RT Channelized	-	-	None	-	-	None	-	-	None	-	-	-	None
Storage Length	-	-	-	-	-	-	240	-	150	-	230	-	175
Veh in Median Storage, #	-	0	-	-	0	-	-	0	-	-	-	0	-
Grade, %	-	0	-	-	0	-	-	0	-	-	-	0	-
Peak Hour Factor	92	92	92	92	92	92	92	92	92	92	92	92	92
Heavy Vehicles, %	2	2	2	2	2	2	2	2	2	2	2	2	2
Mvmt Flow	1	2	12	29	3	74	35	260	17	5	51	301	7

Major/Minor	Minor2		Minor1		Major1		Major2						
Conflicting Flow All	589	760	151	563	750	130	308	0	0	190	277	0	0
Stage 1	413	413	-	330	330	-	-	-	-	-	-	-	-
Stage 2	176	347	-	233	420	-	-	-	-	-	-	-	-
Critical Hdwy	6.44	6.54	7.14	6.44	6.54	7.14	5.34	-	-	5.64	5.34	-	-
Critical Hdwy Stg 1	7.34	5.54	-	7.34	5.54	-	-	-	-	-	-	-	-
Critical Hdwy Stg 2	6.74	5.54	-	6.74	5.54	-	-	-	-	-	-	-	-
Follow-up Hdwy	3.82	4.02	3.92	3.82	4.02	3.92	3.12	-	-	2.32	3.12	-	-
Pot Cap-1 Maneuver	*540	405	738	560	411	*874	833	-	-	*1478	1020	-	-
Stage 1	*501	592	-	741	753	-	-	-	-	-	-	-	-
Stage 2	*897	740	-	688	588	-	-	-	-	-	-	-	-
Platoon blocked, %	1	1		1	1	1		-	-	1	1	-	-
Mov Cap-1 Maneuver	*456	367	738	509	372	*874	833	-	-	*1045	1045	-	-
Mov Cap-2 Maneuver	*456	367	-	509	372	-	-	-	-	-	-	-	-
Stage 1	*480	559	-	710	722	-	-	-	-	-	-	-	-
Stage 2	*783	709	-	637	556	-	-	-	-	-	-	-	-

Approach	EB	WB	NB	SB
HCM Control Delay, s	10.9	11	1.1	1.3
HCM LOS	B	B		

Minor Lane/Major Mvmt	NBL	NBT	NBR	EBLn1	WBLn1	SBL	SBT	SBR
Capacity (veh/h)	833	-	-	621	705	1045	-	-
HCM Lane V/C Ratio	0.042	-	-	0.025	0.151	0.054	-	-
HCM Control Delay (s)	9.5	-	-	10.9	11	8.6	-	-
HCM Lane LOS	A	-	-	B	B	A	-	-
HCM 95th %tile Q(veh)	0.1	-	-	0.1	0.5	0.2	-	-

Notes
 ~: Volume exceeds capacity \$: Delay exceeds 300s +: Computation Not Defined *: All major volume in platoon

HCM 6th TWSC
3: Access A & Dynamic Drive

Existing Traffic Conditions
AM Peak Hour

Intersection												
Int Delay, s/veh	0.8											
Movement	EBL	EBT	EBR	WBL	WBT	WBR	NBL	NBT	NBR	SBL	SBT	SBR
Lane Configurations	↕			↕			↕			↕		
Traffic Vol, veh/h	4	32	13	8	101	0	2	0	1	0	1	0
Future Vol, veh/h	4	32	13	8	101	0	2	0	1	0	1	0
Conflicting Peds, #/hr	0	0	0	0	0	0	0	0	0	0	0	0
Sign Control	Free	Free	Free	Free	Free	Free	Stop	Stop	Stop	Stop	Stop	Stop
RT Channelized	-	-	None	-	-	None	-	-	None	-	-	None
Storage Length	-	-	-	-	-	-	-	-	-	-	-	-
Veh in Median Storage, #	-	0	-	-	0	-	-	0	-	-	0	-
Grade, %	-	0	-	-	0	-	-	0	-	-	0	-
Peak Hour Factor	92	92	92	92	92	92	92	92	92	92	92	92
Heavy Vehicles, %	2	2	2	2	2	2	2	2	2	2	2	2
Mvmt Flow	4	35	14	9	110	0	2	0	1	0	1	0

Major/Minor	Major1			Major2			Minor1			Minor2		
Conflicting Flow All	110	0	0	49	0	0	179	178	42	179	185	110
Stage 1	-	-	-	-	-	-	50	50	-	128	128	-
Stage 2	-	-	-	-	-	-	129	128	-	51	57	-
Critical Hdwy	4.12	-	-	4.12	-	-	7.12	6.52	6.22	7.12	6.52	6.22
Critical Hdwy Stg 1	-	-	-	-	-	-	6.12	5.52	-	6.12	5.52	-
Critical Hdwy Stg 2	-	-	-	-	-	-	6.12	5.52	-	6.12	5.52	-
Follow-up Hdwy	2.218	-	-	2.218	-	-	3.518	4.018	3.318	3.518	4.018	3.318
Pot Cap-1 Maneuver	1480	-	-	1558	-	-	783	716	1029	783	709	943
Stage 1	-	-	-	-	-	-	963	853	-	876	790	-
Stage 2	-	-	-	-	-	-	875	790	-	962	847	-
Platoon blocked, %	-	-	-	-	-	-	-	-	-	-	-	-
Mov Cap-1 Maneuver	1480	-	-	1558	-	-	777	710	1029	777	703	943
Mov Cap-2 Maneuver	-	-	-	-	-	-	777	710	-	777	703	-
Stage 1	-	-	-	-	-	-	960	850	-	873	785	-
Stage 2	-	-	-	-	-	-	869	785	-	958	844	-

Approach	EB			WB			NB			SB		
HCM Control Delay, s	0.6			0.5			9.3			10.1		
HCM LOS							A			B		

Minor Lane/Major Mvmt	NBLn1	EBL	EBT	EBR	WBL	WBT	WBR	SBLn1
Capacity (veh/h)	846	1480	-	-	1558	-	-	703
HCM Lane V/C Ratio	0.004	0.003	-	-	0.006	-	-	0.002
HCM Control Delay (s)	9.3	7.4	0	-	7.3	0	-	10.1
HCM Lane LOS	A	A	A	-	A	A	-	B
HCM 95th %tile Q(veh)	0	0	-	-	0	-	-	0

HCM 6th TWSC
4: Research Parkway & Access B

Existing Traffic Conditions
AM Peak Hour

Intersection												
Int Delay, s/veh	0.6											
Movement	EBL	EBT	EBR	WBL	WBT	WBR	NBL	NBT	NBR	SBL	SBT	SBR
Lane Configurations	↘	↑↑↑	↗	↘	↑↑↑	↗			↗			↗
Traffic Vol, veh/h	25	507	16	37	1151	38	0	0	10	0	0	8
Future Vol, veh/h	25	507	16	37	1151	38	0	0	10	0	0	8
Conflicting Peds, #/hr	0	0	0	0	0	0	0	0	0	0	0	0
Sign Control	Free	Free	Free	Free	Free	Free	Stop	Stop	Stop	Stop	Stop	Stop
RT Channelized	-	-	None	-	-	None	-	-	None	-	-	None
Storage Length	115	-	-	210	-	240	-	-	0	-	-	0
Veh in Median Storage, #	-	0	-	-	0	-	-	0	-	-	0	-
Grade, %	-	0	-	-	0	-	-	0	-	-	0	-
Peak Hour Factor	92	92	92	92	92	92	92	92	92	92	92	92
Heavy Vehicles, %	2	2	2	2	2	2	2	2	2	2	2	2
Mvmt Flow	27	551	17	40	1251	41	0	0	11	0	0	9

Major/Minor	Major1			Major2			Minor1			Minor2		
Conflicting Flow All	1292	0	0	568	0	0	-	-	276	-	-	626
Stage 1	-	-	-	-	-	-	-	-	-	-	-	-
Stage 2	-	-	-	-	-	-	-	-	-	-	-	-
Critical Hdwy	5.34	-	-	5.34	-	-	-	-	7.14	-	-	7.14
Critical Hdwy Stg 1	-	-	-	-	-	-	-	-	-	-	-	-
Critical Hdwy Stg 2	-	-	-	-	-	-	-	-	-	-	-	-
Follow-up Hdwy	3.12	-	-	3.12	-	-	-	-	3.92	-	-	3.92
Pot Cap-1 Maneuver	282	-	-	*1007	-	-	0	0	*801	0	0	366
Stage 1	-	-	-	-	-	-	0	0	-	0	0	-
Stage 2	-	-	-	-	-	-	0	0	-	0	0	-
Platoon blocked, %		-	-	1	-	-			1			
Mov Cap-1 Maneuver	282	-	-	*1007	-	-	-	-	*801	-	-	366
Mov Cap-2 Maneuver	-	-	-	-	-	-	-	-	-	-	-	-
Stage 1	-	-	-	-	-	-	-	-	-	-	-	-
Stage 2	-	-	-	-	-	-	-	-	-	-	-	-





















Approach	EB			WB			NB			SB		
HCM Control Delay, s	0.9			0.3			9.6			15.1		
HCM LOS							A			C		

Minor Lane/Major Mvmt	NBLn1	EBL	EBT	EBR	WBL	WBT	WBR	SBLn1
Capacity (veh/h)	801	282	-	-	* 1007	-	-	366
HCM Lane V/C Ratio	0.014	0.096	-	-	0.04	-	-	0.024
HCM Control Delay (s)	9.6	19.1	-	-	8.7	-	-	15.1
HCM Lane LOS	A	C	-	-	A	-	-	C
HCM 95th %tile Q(veh)	0	0.3	-	-	0.1	-	-	0.1

Notes
 ~: Volume exceeds capacity \$: Delay exceeds 300s +: Computation Not Defined *: All major volume in platoon

Timings
1: Chapel Hills Drive & Research Parkway

Existing Traffic Conditions
PM Peak Hour

												
Lane Group	EBU	EBL	EBT	EBR	WBU	WBL	WBT	WBR	NBU	NBL	NBT	NBR
Lane Configurations												
Traffic Volume (vph)	18	113	934	37	23	175	461	54	6	39	181	162
Future Volume (vph)	18	113	934	37	23	175	461	54	6	39	181	162
Satd. Flow (prot)	0	1770	5085	1583	0	1770	5085	1583	0	1770	3539	1583
Flt Permitted		0.458				0.230				0.592		
Satd. Flow (perm)	0	853	5085	1583	0	428	5085	1583	0	1103	3539	1583
Satd. Flow (RTOR)				107				107				176
Lane Group Flow (vph)	0	143	1015	40	0	215	501	59	0	49	197	176
Turn Type	custom	pm+pt	NA	Perm	custom	pm+pt	NA	Perm	custom	pm+pt	NA	Perm
Protected Phases		5	2			1	6			7	4	
Permitted Phases	5	2		2	1	6		6	7	4		4
Detector Phase	5	5	2	2	1	1	6	6	7	7	4	4
Switch Phase												
Minimum Initial (s)	4.0	4.0	4.0	4.0	4.0	4.0	4.0	4.0	4.0	4.0	4.0	4.0
Minimum Split (s)	9.0	9.0	10.5	10.5	9.0	9.0	10.5	10.5	9.0	9.0	10.5	10.5
Total Split (s)	14.0	14.0	63.0	63.0	14.0	14.0	63.0	63.0	15.0	15.0	46.0	46.0
Total Split (%)	10.1%	10.1%	45.7%	45.7%	10.1%	10.1%	45.7%	45.7%	10.9%	10.9%	33.3%	33.3%
Yellow Time (s)	3.0	3.0	4.5	4.5	3.0	3.0	4.5	4.5	3.0	3.0	4.5	4.5
All-Red Time (s)	2.0	2.0	2.0	2.0	2.0	2.0	2.0	2.0	2.0	2.0	2.0	2.0
Lost Time Adjust (s)		0.0	0.0	0.0		0.0	0.0	0.0		0.0	0.0	0.0
Total Lost Time (s)		5.0	6.5	6.5		5.0	6.5	6.5		5.0	6.5	6.5
Lead/Lag	Lead	Lead	Lag	Lag	Lead	Lead	Lag	Lag	Lead	Lead	Lag	Lag
Lead-Lag Optimize?	Yes	Yes	Yes	Yes	Yes	Yes	Yes	Yes	Yes	Yes	Yes	Yes
Recall Mode	None	None	C-Max	C-Max	None	None	C-Max	C-Max	None	None	None	None
Act Effct Green (s)		90.5	79.9	79.9		96.8	83.1	83.1		22.8	13.1	13.1
Actuated g/C Ratio		0.66	0.58	0.58		0.70	0.60	0.60		0.17	0.09	0.09
v/c Ratio		0.23	0.34	0.04		0.51	0.16	0.06		0.22	0.59	0.57
Control Delay		7.8	16.3	0.1		11.3	12.8	0.2		45.5	66.8	15.4
Queue Delay		0.0	0.0	0.0		0.0	0.0	0.0		0.0	0.0	0.0
Total Delay		7.8	16.3	0.1		11.3	12.8	0.2		45.5	66.8	15.4
LOS		A	B	A		B	B	A		D	E	B
Approach Delay			14.7				11.4					42.9
Approach LOS			B				B					D
Queue Length 50th (ft)		36	167	0		57	69	0		36	90	0
Queue Length 95th (ft)		65	229	0		95	99	2		70	130	70
Internal Link Dist (ft)			699				709				470	
Turn Bay Length (ft)		405		160		315		185		150		330
Base Capacity (vph)		627	2945	961		419	3061	995		244	1012	578
Starvation Cap Reductn		0	0	0		0	0	0		0	0	0
Spillback Cap Reductn		0	0	0		0	0	0		0	0	0
Storage Cap Reductn		0	0	0		0	0	0		0	0	0
Reduced v/c Ratio		0.23	0.34	0.04		0.51	0.16	0.06		0.20	0.19	0.30

Intersection Summary

Cycle Length: 138
 Actuated Cycle Length: 138
 Offset: 10 (7%), Referenced to phase 2:EBTL and 6:WBTL, Start of Green
 Natural Cycle: 60
 Control Type: Actuated-Coordinated

Timings
1: Chapel Hills Drive & Research Parkway

Existing Traffic Conditions
PM Peak Hour



Lane Group	SBL	SBT	SBR
Lane Configurations	↘	↑↑↑	↗
Traffic Volume (vph)	116	228	44
Future Volume (vph)	116	228	44
Satd. Flow (prot)	1770	5085	1583
Flt Permitted	0.487		
Satd. Flow (perm)	907	5085	1583
Satd. Flow (RTOR)			107
Lane Group Flow (vph)	126	248	48
Turn Type	pm+pt	NA	Perm
Protected Phases	3	8	
Permitted Phases	8		8
Detector Phase	3	8	8
Switch Phase			
Minimum Initial (s)	4.0	4.0	4.0
Minimum Split (s)	9.0	10.5	10.5
Total Split (s)	15.0	46.0	46.0
Total Split (%)	10.9%	33.3%	33.3%
Yellow Time (s)	3.0	4.5	4.5
All-Red Time (s)	2.0	2.0	2.0
Lost Time Adjust (s)	0.0	0.0	0.0
Total Lost Time (s)	5.0	6.5	6.5
Lead/Lag	Lead	Lag	Lag
Lead-Lag Optimize?	Yes	Yes	Yes
Recall Mode	None	None	None
Act Effct Green (s)	26.3	16.8	16.8
Actuated g/C Ratio	0.19	0.12	0.12
v/c Ratio	0.54	0.40	0.17
Control Delay	54.9	58.7	1.3
Queue Delay	0.0	0.0	0.0
Total Delay	54.9	58.7	1.3
LOS	D	E	A
Approach Delay		51.0	
Approach LOS		D	
Queue Length 50th (ft)	96	78	0
Queue Length 95th (ft)	153	107	0
Internal Link Dist (ft)		998	
Turn Bay Length (ft)	195		185
Base Capacity (vph)	235	1455	529
Starvation Cap Reductn	0	0	0
Spillback Cap Reductn	0	0	0
Storage Cap Reductn	0	0	0
Reduced v/c Ratio	0.54	0.17	0.09
Intersection Summary			

Timings
 1: Chapel Hills Drive & Research Parkway

Existing Traffic Conditions
 PM Peak Hour

Maximum v/c Ratio: 0.59

Intersection Signal Delay: 23.5









Intersection LOS: C

Intersection Capacity Utilization 64.6%

ICU Level of Service C

Analysis Period (min) 15

Splits and Phases: 1: Chapel Hills Drive & Research Parkway

 Ø1	 Ø2 (R)	 Ø3	 Ø4
14 s	63 s	15 s	46 s
 Ø5	 Ø6 (R)	 Ø7	 Ø8
14 s	63 s	15 s	46 s

HCM 6th TWSC
2: Chapel Hills Drive & Highland Ridge Heights/Dynamic Drive

Existing Traffic Conditions
PM Peak Hour

Intersection													
Int Delay, s/veh	2.3												
Movement	EBL	EBT	EBR	WBL	WBT	WBR	NBL	NBT	NBR	SBU	SBL	SBT	SBR
Lane Configurations		↕			↕		↕	↑↑↑	↕		↕	↑↑↑	↕
Traffic Vol, veh/h	0	4	49	35	0	36	20	327	22	5	33	277	7
Future Vol, veh/h	0	4	49	35	0	36	20	327	22	5	33	277	7
Conflicting Peds, #/hr	0	0	0	0	0	0	0	0	0	0	0	0	0
Sign Control	Stop	Stop	Stop	Stop	Stop	Stop	Free	Free	Free	Free	Free	Free	Free
RT Channelized	-	-	None	-	-	None	-	-	None	-	-	-	None
Storage Length	-	-	-	-	-	-	240	-	150	-	230	-	175
Veh in Median Storage, #	-	0	-	-	0	-	-	0	-	-	-	0	-
Grade, %	-	0	-	-	0	-	-	0	-	-	-	0	-
Peak Hour Factor	92	92	92	92	92	92	92	92	92	92	92	92	92
Heavy Vehicles, %	2	2	2	2	2	2	2	2	2	2	2	2	2
Mvmt Flow	0	4	53	38	0	39	22	355	24	5	36	301	8

Major/Minor	Minor2		Minor1		Major1			Major2					
Conflicting Flow All	569	806	151	603	790	178	309	0	0	259	379	0	0
Stage 1	383	383	-	399	399	-	-	-	-	-	-	-	-
Stage 2	186	423	-	204	391	-	-	-	-	-	-	-	-
Critical Hdwy	6.44	6.54	7.14	6.44	6.54	7.14	5.34	-	-	5.64	5.34	-	-
Critical Hdwy Stg 1	7.34	5.54	-	7.34	5.54	-	-	-	-	-	-	-	-
Critical Hdwy Stg 2	6.74	5.54	-	6.74	5.54	-	-	-	-	-	-	-	-
Follow-up Hdwy	3.82	4.02	3.92	3.82	4.02	3.92	3.12	-	-	2.32	3.12	-	-
Pot Cap-1 Maneuver	*610	417	738	582	426	*856	832	-	-	*1446	986	-	-
Stage 1	*525	610	-	750	754	-	-	-	-	-	-	-	-
Stage 2	*878	734	-	715	606	-	-	-	-	-	-	-	-
Platoon blocked, %	1	1		1	1	1		-	-	1	1	-	-
Mov Cap-1 Maneuver	*553	390	738	509	399	*856	832	-	-	*1025	1025	-	-
Mov Cap-2 Maneuver	*553	390	-	509	399	-	-	-	-	-	-	-	-
Stage 1	*511	586	-	731	734	-	-	-	-	-	-	-	-
Stage 2	*816	715	-	632	582	-	-	-	-	-	-	-	-

Approach	EB		WB		NB			SB			
HCM Control Delay, s	10.7		11.4		0.5			1			
HCM LOS	B		B								

Minor Lane/Major Mvmt	NBL	NBT	NBR	EBLn1	WBLn1	SBL	SBT	SBR
Capacity (veh/h)	832	-	-	691	641	1025	-	-
HCM Lane V/C Ratio	0.026	-	-	0.083	0.12	0.04	-	-
HCM Control Delay (s)	9.4	-	-	10.7	11.4	8.7	-	-
HCM Lane LOS	A	-	-	B	B	A	-	-
HCM 95th %tile Q(veh)	0.1	-	-	0.3	0.4	0.1	-	-

Notes
~: Volume exceeds capacity \$: Delay exceeds 300s +: Computation Not Defined *: All major volume in platoon

HCM 6th TWSC
3: Access A & Dynamic Drive

Existing Traffic Conditions
PM Peak Hour

Intersection												
Int Delay, s/veh	1.7											
Movement	EBL	EBT	EBR	WBL	WBT	WBR	NBL	NBT	NBR	SBL	SBT	SBR
Lane Configurations	↕			↕			↕			↕		
Traffic Vol, veh/h	0	77	1	2	40	1	3	1	11	3	1	7
Future Vol, veh/h	0	77	1	2	40	1	3	1	11	3	1	7
Conflicting Peds, #/hr	0	0	0	0	0	0	0	0	0	0	0	0
Sign Control	Free	Free	Free	Free	Free	Free	Stop	Stop	Stop	Stop	Stop	Stop
RT Channelized	-	-	None	-	-	None	-	-	None	-	-	None
Storage Length	-	-	-	-	-	-	-	-	-	-	-	-
Veh in Median Storage, #	-	0	-	-	0	-	-	0	-	-	0	-
Grade, %	-	0	-	-	0	-	-	0	-	-	0	-
Peak Hour Factor	92	92	92	92	92	92	92	92	92	92	92	92
Heavy Vehicles, %	2	2	2	2	2	2	2	2	2	2	2	2
Mvmt Flow	0	84	1	2	43	1	3	1	12	3	1	8

Major/Minor	Major1		Major2		Minor1		Minor2					
Conflicting Flow All	44	0	0	85	0	0	137	133	85	139	133	44
Stage 1	-	-	-	-	-	-	85	85	-	48	48	-
Stage 2	-	-	-	-	-	-	52	48	-	91	85	-
Critical Hdwy	4.12	-	-	4.12	-	-	7.12	6.52	6.22	7.12	6.52	6.22
Critical Hdwy Stg 1	-	-	-	-	-	-	6.12	5.52	-	6.12	5.52	-
Critical Hdwy Stg 2	-	-	-	-	-	-	6.12	5.52	-	6.12	5.52	-
Follow-up Hdwy	2.218	-	-	2.218	-	-	3.518	4.018	3.318	3.518	4.018	3.318
Pot Cap-1 Maneuver	1564	-	-	1512	-	-	834	758	974	831	758	1026
Stage 1	-	-	-	-	-	-	923	824	-	965	855	-
Stage 2	-	-	-	-	-	-	961	855	-	916	824	-
Platoon blocked, %	-	-	-	-	-	-	-	-	-	-	-	-
Mov Cap-1 Maneuver	1564	-	-	1512	-	-	826	757	974	819	757	1026
Mov Cap-2 Maneuver	-	-	-	-	-	-	826	757	-	819	757	-
Stage 1	-	-	-	-	-	-	923	824	-	965	854	-
Stage 2	-	-	-	-	-	-	952	854	-	904	824	-

Approach	EB		WB		NB		SB	
HCM Control Delay, s	0		0.3		9		8.9	
HCM LOS					A		A	

Minor Lane/Major Mvmt	NBLn1	EBL	EBT	EBR	WBL	WBT	WBR	SBLn1
Capacity (veh/h)	923	1564	-	-	1512	-	-	932
HCM Lane V/C Ratio	0.018	-	-	-	0.001	-	-	0.013
HCM Control Delay (s)	9	0	-	-	7.4	0	-	8.9
HCM Lane LOS	A	A	-	-	A	A	-	A
HCM 95th %tile Q(veh)	0.1	0	-	-	0	-	-	0

HCM 6th TWSC
4: Research Parkway & Access B

Existing Traffic Conditions
PM Peak Hour

Intersection												
Int Delay, s/veh	0.5											
Movement	EBL	EBT	EBR	WBL	WBT	WBR	NBL	NBT	NBR	SBL	SBT	SBR
Lane Configurations	↘	↑↑↑	↗	↘	↑↑↑	↗			↗			↗
Traffic Vol, veh/h	11	1212	5	6	654	10	0	0	52	0	0	11
Future Vol, veh/h	11	1212	5	6	654	10	0	0	52	0	0	11
Conflicting Peds, #/hr	0	0	0	0	0	0	0	0	0	0	0	0
Sign Control	Free	Free	Free	Free	Free	Free	Stop	Stop	Stop	Stop	Stop	Stop
RT Channelized	-	-	None	-	-	None	-	-	None	-	-	None
Storage Length	115	-	-	210	-	240	-	-	0	-	-	0
Veh in Median Storage, #	-	0	-	-	0	-	-	0	-	-	0	-
Grade, %	-	0	-	-	0	-	-	0	-	-	0	-
Peak Hour Factor	92	92	92	92	92	92	92	92	92	92	92	92
Heavy Vehicles, %	2	2	2	2	2	2	2	2	2	2	2	2
Mvmt Flow	12	1317	5	7	711	11	0	0	57	0	0	12

Major/Minor	Major1			Major2			Minor1			Minor2		
Conflicting Flow All	722	0	0	1322	0	0	-	-	659	-	-	356
Stage 1	-	-	-	-	-	-	-	-	-	-	-	-
Stage 2	-	-	-	-	-	-	-	-	-	-	-	-
Critical Hdwy	5.34	-	-	5.34	-	-	-	-	7.14	-	-	7.14
Critical Hdwy Stg 1	-	-	-	-	-	-	-	-	-	-	-	-
Critical Hdwy Stg 2	-	-	-	-	-	-	-	-	-	-	-	-
Follow-up Hdwy	3.12	-	-	3.12	-	-	-	-	3.92	-	-	3.92
Pot Cap-1 Maneuver	532	-	-	*794	-	-	0	0	*631	0	0	547
Stage 1	-	-	-	-	-	-	0	0	-	0	0	-
Stage 2	-	-	-	-	-	-	0	0	-	0	0	-
Platoon blocked, %		-	-	1	-	-			1			
Mov Cap-1 Maneuver	532	-	-	*794	-	-	-	-	*631	-	-	547
Mov Cap-2 Maneuver	-	-	-	-	-	-	-	-	-	-	-	-
Stage 1	-	-	-	-	-	-	-	-	-	-	-	-
Stage 2	-	-	-	-	-	-	-	-	-	-	-	-

Approach	EB			WB			NB			SB		
HCM Control Delay, s	0.1			0.1			11.3			11.7		
HCM LOS							B			B		

Minor Lane/Major Mvmt	NBLn1	EBL	EBT	EBR	WBL	WBT	WBR	SBLn1
Capacity (veh/h)	631	532	-	-	* 794	-	-	547
HCM Lane V/C Ratio	0.09	0.022	-	-	0.008	-	-	0.022
HCM Control Delay (s)	11.3	11.9	-	-	9.6	-	-	11.7
HCM Lane LOS	B	B	-	-	A	-	-	B
HCM 95th %tile Q(veh)	0.3	0.1	-	-	0	-	-	0.1

Notes
 ~: Volume exceeds capacity \$: Delay exceeds 300s +: Computation Not Defined *: All major volume in platoon

Timings
1: Chapel Hills Drive & Research Parkway

Background Traffic Conditions
Year 2024 - AM Peak Hour

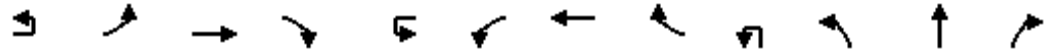

Lane Group	EBU	EBL	EBT	EBR	WBU	WBL	WBT	WBR	NBU	NBL	NBT	NBR
Lane Configurations		↔	↑↑↑	↗		↔	↑↑↑	↗		↔	↑↑	↗
Traffic Volume (vph)	1	68	436	48	8	191	874	162	4	25	118	52
Future Volume (vph)	1	68	436	48	8	191	874	162	4	25	118	52
Satd. Flow (prot)	0	1770	5085	1583	0	1770	5085	1583	0	1770	3539	1583
Flt Permitted		0.285				0.446				0.618		
Satd. Flow (perm)	0	531	5085	1583	0	831	5085	1583	0	1151	3539	1583
Satd. Flow (RTOR)				107				176				107
Lane Group Flow (vph)	0	75	474	52	0	217	950	176	0	31	128	57
Turn Type	custom	pm+pt	NA	Perm	custom	pm+pt	NA	Perm	custom	pm+pt	NA	Perm
Protected Phases		5	2			1	6			7	4	
Permitted Phases	5	2		2	1	6		6	7	4		4
Detector Phase	5	5	2	2	1	1	6	6	7	7	4	4
Switch Phase												
Minimum Initial (s)	4.0	4.0	4.0	4.0	4.0	4.0	4.0	4.0	4.0	4.0	4.0	4.0
Minimum Split (s)	9.0	9.0	10.5	10.5	9.0	9.0	10.5	10.5	9.0	9.0	10.5	10.5
Total Split (s)	14.0	14.0	63.0	63.0	14.0	14.0	63.0	63.0	15.0	15.0	46.0	46.0
Total Split (%)	10.1%	10.1%	45.7%	45.7%	10.1%	10.1%	45.7%	45.7%	10.9%	10.9%	33.3%	33.3%
Yellow Time (s)	3.0	3.0	4.5	4.5	3.0	3.0	4.5	4.5	3.0	3.0	4.5	4.5
All-Red Time (s)	2.0	2.0	2.0	2.0	2.0	2.0	2.0	2.0	2.0	2.0	2.0	2.0
Lost Time Adjust (s)		0.0	0.0	0.0		0.0	0.0	0.0		0.0	0.0	0.0
Total Lost Time (s)		5.0	6.5	6.5		5.0	6.5	6.5		5.0	6.5	6.5
Lead/Lag	Lead	Lead	Lag	Lag	Lead	Lead	Lag	Lag	Lead	Lead	Lag	Lag
Lead-Lag Optimize?	Yes	Yes	Yes	Yes	Yes	Yes	Yes	Yes	Yes	Yes	Yes	Yes
Recall Mode	None	None	C-Max	C-Max	None	None	C-Max	C-Max	None	None	None	None
Act Effct Green (s)		93.0	84.4	84.4		100.7	90.1	90.1		19.4	10.4	10.4
Actuated g/C Ratio		0.67	0.61	0.61		0.73	0.65	0.65		0.14	0.08	0.08
v/c Ratio		0.18	0.15	0.05		0.32	0.29	0.16		0.16	0.48	0.26
Control Delay		6.8	12.2	0.1		7.1	11.2	1.9		46.7	67.0	2.9
Queue Delay		0.0	0.0	0.0		0.0	0.0	0.0		0.0	0.0	0.0
Total Delay		6.8	12.2	0.1		7.1	11.2	1.9		46.7	67.0	2.9
LOS		A	B	A		A	B	A		D	E	A
Approach Delay			10.5				9.3				47.2	
Approach LOS			B				A				D	
Queue Length 50th (ft)		17	63	0		53	132	0		23	58	0
Queue Length 95th (ft)		34	92	0		87	172	29		52	92	1
Internal Link Dist (ft)			699				709				470	
Turn Bay Length (ft)		405		160		315		185		150		330
Base Capacity (vph)		445	3108	1009		681	3320	1094		227	1012	529
Starvation Cap Reductn		0	0	0		0	0	0		0	0	0
Spillback Cap Reductn		0	0	0		0	0	0		0	0	0
Storage Cap Reductn		0	0	0		0	0	0		0	0	0
Reduced v/c Ratio		0.17	0.15	0.05		0.32	0.29	0.16		0.14	0.13	0.11

Intersection Summary
 Cycle Length: 138
 Actuated Cycle Length: 138
 Offset: 10 (7%), Referenced to phase 2:EBTL and 6:WBTL, Start of Green
 Natural Cycle: 50
 Control Type: Actuated-Coordinated

Timings
1: Chapel Hills Drive & Research Parkway

Background Traffic Conditions
Year 2024 - AM Peak Hour



Lane Group	SBL	SBT	SBR
Lane Configurations	↘	↑↑↑	↗
Traffic Volume (vph)	88	188	54
Future Volume (vph)	88	188	54
Satd. Flow (prot)	1770	5085	1583
Flt Permitted	0.495		
Satd. Flow (perm)	922	5085	1583
Satd. Flow (RTOR)			107
Lane Group Flow (vph)	96	204	59
Turn Type	pm+pt	NA	Perm
Protected Phases	3	8	
Permitted Phases	8		8
Detector Phase	3	8	8
Switch Phase			
Minimum Initial (s)	4.0	4.0	4.0
Minimum Split (s)	9.0	10.5	10.5
Total Split (s)	15.0	46.0	46.0
Total Split (%)	10.9%	33.3%	33.3%
Yellow Time (s)	3.0	4.5	4.5
All-Red Time (s)	2.0	2.0	2.0
Lost Time Adjust (s)	0.0	0.0	0.0
Total Lost Time (s)	5.0	6.5	6.5
Lead/Lag	Lead	Lag	Lag
Lead-Lag Optimize?	Yes	Yes	Yes
Recall Mode	None	None	None
Act Effct Green (s)	24.3	16.8	16.8
Actuated g/C Ratio	0.18	0.12	0.12
v/c Ratio	0.43	0.33	0.21
Control Delay	53.5	58.1	2.0
Queue Delay	0.0	0.0	0.0
Total Delay	53.5	58.1	2.0
LOS	D	E	A
Approach Delay		47.7	
Approach LOS		D	
Queue Length 50th (ft)	74	64	0
Queue Length 95th (ft)	125	93	4
Internal Link Dist (ft)		998	
Turn Bay Length (ft)	195		185
Base Capacity (vph)	223	1455	529
Starvation Cap Reductn	0	0	0
Spillback Cap Reductn	0	0	0
Storage Cap Reductn	0	0	0
Reduced v/c Ratio	0.43	0.14	0.11
Intersection Summary			

Timings
 1: Chapel Hills Drive & Research Parkway

Background Traffic Conditions
 Year 2024 - AM Peak Hour

Maximum v/c Ratio: 0.48	
Intersection Signal Delay: 18.3	Intersection LOS: B
Intersection Capacity Utilization 48.1%	ICU Level of Service A
Analysis Period (min) 15	

Splits and Phases: 1: Chapel Hills Drive & Research Parkway

 Ø1	 Ø2 (R)	 Ø3	 Ø4
14 s	63 s	15 s	46 s
 Ø5	 Ø6 (R)	 Ø7	 Ø8
14 s	63 s	15 s	46 s

HCM 6th TWSC
 2: Chapel Hills Drive & Highland Ridge Heights/Dynamic Drive

Background Traffic Conditions
 Year 2024 - AM Peak Hour

Intersection													
Int Delay, s/veh	2.8												
Movement	EBL	EBT	EBR	WBL	WBT	WBR	NBL	NBT	NBR	SBU	SBL	SBT	SBR
Lane Configurations		↕			↕		↕	↑↑↑	↕		↕	↑↑↑	↕
Traffic Vol, veh/h	1	2	12	29	3	72	34	254	17	5	50	294	6
Future Vol, veh/h	1	2	12	29	3	72	34	254	17	5	50	294	6
Conflicting Peds, #/hr	0	0	0	0	0	0	0	0	0	0	0	0	0
Sign Control	Stop	Stop	Stop	Stop	Stop	Stop	Free	Free	Free	Free	Free	Free	Free
RT Channelized	-	-	None	-	-	None	-	-	None	-	-	-	None
Storage Length	-	-	-	-	-	-	240	-	150	-	230	-	175
Veh in Median Storage, #	-	0	-	-	0	-	-	0	-	-	-	0	-
Grade, %	-	0	-	-	0	-	-	0	-	-	-	0	-
Peak Hour Factor	92	92	92	92	92	92	92	92	92	92	92	92	92
Heavy Vehicles, %	2	2	2	2	2	2	2	2	2	2	2	2	2
Mvmt Flow	1	2	13	32	3	78	37	276	18	5	54	320	7

Major/Minor	Minor2		Minor1		Major1		Major2						
Conflicting Flow All	624	806	160	597	795	138	327	0	0	202	294	0	0
Stage 1	438	438	-	350	350	-	-	-	-	-	-	-	-
Stage 2	186	368	-	247	445	-	-	-	-	-	-	-	-
Critical Hdwy	6.44	6.54	7.14	6.44	6.54	7.14	5.34	-	-	5.64	5.34	-	-
Critical Hdwy Stg 1	7.34	5.54	-	7.34	5.54	-	-	-	-	-	-	-	-
Critical Hdwy Stg 2	6.74	5.54	-	6.74	5.54	-	-	-	-	-	-	-	-
Follow-up Hdwy	3.82	4.02	3.92	3.82	4.02	3.92	3.12	-	-	2.32	3.12	-	-
Pot Cap-1 Maneuver	*515	381	729	534	386	*874	816	-	-	*1478	1001	-	-
Stage 1	*482	577	-	718	737	-	-	-	-	-	-	-	-
Stage 2	*897	724	-	675	573	-	-	-	-	-	-	-	-
Platoon blocked, %	1	1		1	1	1		-	-	1	1	-	-
Mov Cap-1 Maneuver	*429	342	729	482	347	*874	816	-	-	*1025	1025	-	-
Mov Cap-2 Maneuver	*429	342	-	482	347	-	-	-	-	-	-	-	-
Stage 1	*460	543	-	686	704	-	-	-	-	-	-	-	-
Stage 2	*776	691	-	622	539	-	-	-	-	-	-	-	-

Approach	EB	WB	NB	SB
HCM Control Delay, s	11.1	11.3	1.1	1.4
HCM LOS	B	B		

Minor Lane/Major Mvmt	NBL	NBT	NBR	EBLn1	WBLn1	SBL	SBT	SBR
Capacity (veh/h)	816	-	-	609	688	1025	-	-
HCM Lane V/C Ratio	0.045	-	-	0.027	0.164	0.058	-	-
HCM Control Delay (s)	9.6	-	-	11.1	11.3	8.7	-	-
HCM Lane LOS	A	-	-	B	B	A	-	-
HCM 95th %tile Q(veh)	0.1	-	-	0.1	0.6	0.2	-	-

Notes
 ~: Volume exceeds capacity \$: Delay exceeds 300s +: Computation Not Defined *: All major volume in platoon

HCM 6th TWSC
3: Access A & Dynamic Drive

Background Traffic Conditions
Year 2024 - AM Peak Hour

Intersection												
Int Delay, s/veh	0.7											
Movement	EBL	EBT	EBR	WBL	WBT	WBR	NBL	NBT	NBR	SBL	SBT	SBR
Lane Configurations	↕			↕			↕			↕		
Traffic Vol, veh/h	4	34	15	8	107	0	2	0	1	0	1	0
Future Vol, veh/h	4	34	15	8	107	0	2	0	1	0	1	0
Conflicting Peds, #/hr	0	0	0	0	0	0	0	0	0	0	0	0
Sign Control	Free	Free	Free	Free	Free	Free	Stop	Stop	Stop	Stop	Stop	Stop
RT Channelized	-	-	None	-	-	None	-	-	None	-	-	None
Storage Length	-	-	-	-	-	-	-	-	-	-	-	-
Veh in Median Storage, #	-	0	-	-	0	-	-	0	-	-	0	-
Grade, %	-	0	-	-	0	-	-	0	-	-	0	-
Peak Hour Factor	92	92	92	92	92	92	92	92	92	92	92	92
Heavy Vehicles, %	2	2	2	2	2	2	2	2	2	2	2	2
Mvmt Flow	4	37	16	9	116	0	2	0	1	0	1	0

Major/Minor	Major1			Major2			Minor1			Minor2		
Conflicting Flow All	116	0	0	53	0	0	188	187	45	188	195	116
Stage 1	-	-	-	-	-	-	53	53	-	134	134	-
Stage 2	-	-	-	-	-	-	135	134	-	54	61	-
Critical Hdwy	4.12	-	-	4.12	-	-	7.12	6.52	6.22	7.12	6.52	6.22
Critical Hdwy Stg 1	-	-	-	-	-	-	6.12	5.52	-	6.12	5.52	-
Critical Hdwy Stg 2	-	-	-	-	-	-	6.12	5.52	-	6.12	5.52	-
Follow-up Hdwy	2.218	-	-	2.218	-	-	3.518	4.018	3.318	3.518	4.018	3.318
Pot Cap-1 Maneuver	1473	-	-	1553	-	-	772	708	1025	772	700	936
Stage 1	-	-	-	-	-	-	960	851	-	869	785	-
Stage 2	-	-	-	-	-	-	868	785	-	958	844	-
Platoon blocked, %	-	-	-	-	-	-	-	-	-	-	-	-
Mov Cap-1 Maneuver	1473	-	-	1553	-	-	766	702	1025	766	694	936
Mov Cap-2 Maneuver	-	-	-	-	-	-	766	702	-	766	694	-
Stage 1	-	-	-	-	-	-	957	848	-	866	780	-
Stage 2	-	-	-	-	-	-	862	780	-	954	841	-

Approach	EB			WB			NB			SB		
HCM Control Delay, s	0.6			0.5			9.3			10.2		
HCM LOS							A			B		

Minor Lane/Major Mvmt	NBLn1	EBL	EBT	EBR	WBL	WBT	WBR	SBLn1
Capacity (veh/h)	836	1473	-	-	1553	-	-	694
HCM Lane V/C Ratio	0.004	0.003	-	-	0.006	-	-	0.002
HCM Control Delay (s)	9.3	7.5	0	-	7.3	0	-	10.2
HCM Lane LOS	A	A	A	-	A	A	-	B
HCM 95th %tile Q(veh)	0	0	-	-	0	-	-	0

HCM 6th TWSC
4: Research Parkway & Access B

Background Traffic Conditions
Year 2024 - AM Peak Hour

Intersection												
Int Delay, s/veh	0.6											
Movement	EBL	EBT	EBR	WBL	WBT	WBR	NBL	NBT	NBR	SBL	SBT	SBR
Lane Configurations	↘	↑↑↑	↗	↘	↑↑↑	↗			↗			↗
Traffic Vol, veh/h	27	538	17	39	1221	40	0	0	11	0	0	8
Future Vol, veh/h	27	538	17	39	1221	40	0	0	11	0	0	8
Conflicting Peds, #/hr	0	0	0	0	0	0	0	0	0	0	0	0
Sign Control	Free	Free	Free	Free	Free	Free	Stop	Stop	Stop	Stop	Stop	Stop
RT Channelized	-	-	None	-	-	None	-	-	None	-	-	None
Storage Length	115	-	-	210	-	240	-	-	0	-	-	0
Veh in Median Storage, #	-	0	-	-	0	-	-	0	-	-	0	-
Grade, %	-	0	-	-	0	-	-	0	-	-	0	-
Peak Hour Factor	92	92	92	92	92	92	92	92	92	92	92	92
Heavy Vehicles, %	2	2	2	2	2	2	2	2	2	2	2	2
Mvmt Flow	29	585	18	42	1327	43	0	0	12	0	0	9

Major/Minor	Major1		Major2		Minor1		Minor2					
Conflicting Flow All	1370	0	0	603	0	0	-	-	293	-	-	664
Stage 1	-	-	-	-	-	-	-	-	-	-	-	-
Stage 2	-	-	-	-	-	-	-	-	-	-	-	-
Critical Hdwy	5.34	-	-	5.34	-	-	-	-	7.14	-	-	7.14
Critical Hdwy Stg 1	-	-	-	-	-	-	-	-	-	-	-	-
Critical Hdwy Stg 2	-	-	-	-	-	-	-	-	-	-	-	-
Follow-up Hdwy	3.12	-	-	3.12	-	-	-	-	3.92	-	-	3.92
Pot Cap-1 Maneuver	258	-	-	970	-	-	0	0	*801	0	0	346
Stage 1	-	-	-	-	-	-	0	0	-	0	0	-
Stage 2	-	-	-	-	-	-	0	0	-	0	0	-
Platoon blocked, %		-	-	1	-	-			1			
Mov Cap-1 Maneuver	258	-	-	970	-	-	-	-	*801	-	-	346
Mov Cap-2 Maneuver	-	-	-	-	-	-	-	-	-	-	-	-
Stage 1	-	-	-	-	-	-	-	-	-	-	-	-
Stage 2	-	-	-	-	-	-	-	-	-	-	-	-

Approach	EB		WB		NB		SB	
HCM Control Delay, s	1		0.3		9.6		15.7	
HCM LOS					A		C	

Minor Lane/Major Mvmt	NBLn1	EBL	EBT	EBR	WBL	WBT	WBR	SBLn1
Capacity (veh/h)	801	258	-	-	970	-	-	346
HCM Lane V/C Ratio	0.015	0.114	-	-	0.044	-	-	0.025
HCM Control Delay (s)	9.6	20.7	-	-	8.9	-	-	15.7
HCM Lane LOS	A	C	-	-	A	-	-	C
HCM 95th %tile Q(veh)	0	0.4	-	-	0.1	-	-	0.1

Notes
 ~: Volume exceeds capacity \$: Delay exceeds 300s +: Computation Not Defined *: All major volume in platoon

Timings
1: Chapel Hills Drive & Research Parkway

Background Traffic Conditions
Year 2024 - PM Peak Hour

Lane Group	EBU	EBL	EBT	EBR	WBU	WBL	WBT	WBR	NBU	NBL	NBT	NBR
Lane Configurations												
Traffic Volume (vph)	19	120	991	39	24	186	489	57	6	41	192	172
Future Volume (vph)	19	120	991	39	24	186	489	57	6	41	192	172
Satd. Flow (prot)	0	1770	5085	1583	0	1770	5085	1583	0	1770	3539	1583
Flt Permitted		0.444				0.204				0.583		
Satd. Flow (perm)	0	827	5085	1583	0	380	5085	1583	0	1086	3539	1583
Satd. Flow (RTOR)				107				107				187
Lane Group Flow (vph)	0	151	1077	42	0	228	532	62	0	52	209	187
Turn Type	custom	pm+pt	NA	Perm	custom	pm+pt	NA	Perm	custom	pm+pt	NA	Perm
Protected Phases		5	2			1	6			7	4	
Permitted Phases	5	2		2	1	6		6	7	4		4
Detector Phase	5	5	2	2	1	1	6	6	7	7	4	4
Switch Phase												
Minimum Initial (s)	4.0	4.0	4.0	4.0	4.0	4.0	4.0	4.0	4.0	4.0	4.0	4.0
Minimum Split (s)	9.0	9.0	10.5	10.5	9.0	9.0	10.5	10.5	9.0	9.0	10.5	10.5
Total Split (s)	14.0	14.0	63.0	63.0	14.0	14.0	63.0	63.0	15.0	15.0	46.0	46.0
Total Split (%)	10.1%	10.1%	45.7%	45.7%	10.1%	10.1%	45.7%	45.7%	10.9%	10.9%	33.3%	33.3%
Yellow Time (s)	3.0	3.0	4.5	4.5	3.0	3.0	4.5	4.5	3.0	3.0	4.5	4.5
All-Red Time (s)	2.0	2.0	2.0	2.0	2.0	2.0	2.0	2.0	2.0	2.0	2.0	2.0
Lost Time Adjust (s)		0.0	0.0	0.0		0.0	0.0	0.0		0.0	0.0	0.0
Total Lost Time (s)		5.0	6.5	6.5		5.0	6.5	6.5		5.0	6.5	6.5
Lead/Lag	Lead	Lead	Lag	Lag	Lead	Lead	Lag	Lag	Lead	Lead	Lag	Lag
Lead-Lag Optimize?	Yes	Yes	Yes	Yes	Yes	Yes	Yes	Yes	Yes	Yes	Yes	Yes
Recall Mode	None	None	C-Max	C-Max	None	None	C-Max	C-Max	None	None	None	None
Act Effct Green (s)		88.0	77.2	77.2		97.6	82.3	82.3		23.4	13.5	13.5
Actuated g/C Ratio		0.64	0.56	0.56		0.71	0.60	0.60		0.17	0.10	0.10
v/c Ratio		0.26	0.38	0.05		0.55	0.18	0.06		0.23	0.60	0.58
Control Delay		8.3	18.2	0.1		12.3	13.3	0.4		45.2	66.8	15.0
Queue Delay		0.0	0.0	0.0		0.0	0.0	0.0		0.0	0.0	0.0
Total Delay		8.3	18.2	0.1		12.3	13.3	0.4		45.2	66.8	15.0
LOS		A	B	A		B	B	A		D	E	B
Approach Delay			16.4				12.0					42.7
Approach LOS			B				B					D
Queue Length 50th (ft)		39	189	0		62	75	0		38	96	0
Queue Length 95th (ft)		69	257	0		103	107	3		74	135	72
Internal Link Dist (ft)			699				709				470	
Turn Bay Length (ft)		405		160		315		185		150		330
Base Capacity (vph)		598	2845	932		413	3031	986		246	1012	586
Starvation Cap Reductn		0	0	0		0	0	0		0	0	0
Spillback Cap Reductn		0	0	0		0	0	0		0	0	0
Storage Cap Reductn		0	0	0		0	0	0		0	0	0
Reduced v/c Ratio		0.25	0.38	0.05		0.55	0.18	0.06		0.21	0.21	0.32

Intersection Summary
 Cycle Length: 138
 Actuated Cycle Length: 138
 Offset: 10 (7%), Referenced to phase 2:EBTL and 6:WBTL, Start of Green
 Natural Cycle: 60
 Control Type: Actuated-Coordinated

Timings
1: Chapel Hills Drive & Research Parkway

Background Traffic Conditions
Year 2024 - PM Peak Hour











Lane Group	SBL	SBT	SBR
Lane Configurations			
Traffic Volume (vph)	123	242	47
Future Volume (vph)	123	242	47
Satd. Flow (prot)	1770	5085	1583
Flt Permitted	0.468		
Satd. Flow (perm)	872	5085	1583
Satd. Flow (RTOR)			107
Lane Group Flow (vph)	134	263	51
Turn Type	pm+pt	NA	Perm
Protected Phases	3	8	
Permitted Phases	8		8
Detector Phase	3	8	8
Switch Phase			
Minimum Initial (s)	4.0	4.0	4.0
Minimum Split (s)	9.0	10.5	10.5
Total Split (s)	15.0	46.0	46.0
Total Split (%)	10.9%	33.3%	33.3%
Yellow Time (s)	3.0	4.5	4.5
All-Red Time (s)	2.0	2.0	2.0
Lost Time Adjust (s)	0.0	0.0	0.0
Total Lost Time (s)	5.0	6.5	6.5
Lead/Lag	Lead	Lag	Lag
Lead-Lag Optimize?	Yes	Yes	Yes
Recall Mode	None	None	None
Act Effct Green (s)	26.7	17.2	17.2
Actuated g/C Ratio	0.19	0.12	0.12
v/c Ratio	0.58	0.42	0.18
Control Delay	56.3	58.5	1.3
Queue Delay	0.0	0.0	0.0
Total Delay	56.3	58.5	1.3
LOS	E	E	A
Approach Delay		51.4	
Approach LOS		D	
Queue Length 50th (ft)	103	82	0
Queue Length 95th (ft)	161	112	0
Internal Link Dist (ft)		998	
Turn Bay Length (ft)	195		185
Base Capacity (vph)	233	1455	529
Starvation Cap Reductn	0	0	0
Spillback Cap Reductn	0	0	0
Storage Cap Reductn	0	0	0
Reduced v/c Ratio	0.58	0.18	0.10
Intersection Summary			

Timings
 1: Chapel Hills Drive & Research Parkway

Background Traffic Conditions
 Year 2024 - PM Peak Hour

Maximum v/c Ratio: 0.60	
Intersection Signal Delay: 24.4	Intersection LOS: C
Intersection Capacity Utilization 67.4%	ICU Level of Service C
Analysis Period (min) 15	

Splits and Phases: 1: Chapel Hills Drive & Research Parkway

 Ø1	 Ø2 (R)	 Ø3	 Ø4
14 s	63 s	15 s	46 s
 Ø5	 Ø6 (R)	 Ø7	 Ø8
14 s	63 s	15 s	46 s

HCM 6th TWSC
 2: Chapel Hills Drive & Highland Ridge Heights/Dynamic Drive

Background Traffic Conditions
 Year 2024 - PM Peak Hour

Intersection													
Int Delay, s/veh	2.3												
Movement	EBL	EBT	EBR	WBL	WBT	WBR	NBL	NBT	NBR	SBU	SBL	SBT	SBR
Lane Configurations		↕			↕		↕	↑↑↑	↑		↕	↑↑↑	↑
Traffic Vol, veh/h	0	4	52	37	0	38	21	347	23	5	35	294	7
Future Vol, veh/h	0	4	52	37	0	38	21	347	23	5	35	294	7
Conflicting Peds, #/hr	0	0	0	0	0	0	0	0	0	0	0	0	0
Sign Control	Stop	Stop	Stop	Stop	Stop	Stop	Free	Free	Free	Free	Free	Free	Free
RT Channelized	-	-	None	-	-	None	-	-	None	-	-	-	None
Storage Length	-	-	-	-	-	-	240	-	150	-	230	-	175
Veh in Median Storage, #	-	0	-	-	0	-	-	0	-	-	-	0	-
Grade, %	-	0	-	-	0	-	-	0	-	-	-	0	-
Peak Hour Factor	92	92	92	92	92	92	92	92	92	92	92	92	92
Heavy Vehicles, %	2	2	2	2	2	2	2	2	2	2	2	2	2
Mvmt Flow	0	4	57	40	0	41	23	377	25	5	38	320	8

Major/Minor	Minor2		Minor1		Major1			Major2					
Conflicting Flow All	603	854	160	639	837	189	328	0	0	275	402	0	0
Stage 1	406	406	-	423	423	-	-	-	-	-	-	-	-
Stage 2	197	448	-	216	414	-	-	-	-	-	-	-	-
Critical Hdwy	6.44	6.54	7.14	6.44	6.54	7.14	5.34	-	-	5.64	5.34	-	-
Critical Hdwy Stg 1	7.34	5.54	-	7.34	5.54	-	-	-	-	-	-	-	-
Critical Hdwy Stg 2	6.74	5.54	-	6.74	5.54	-	-	-	-	-	-	-	-
Follow-up Hdwy	3.82	4.02	3.92	3.82	4.02	3.92	3.12	-	-	2.32	3.12	-	-
Pot Cap-1 Maneuver	*582	389	729	554	398	*856	815	-	-	*1446	961	-	-
Stage 1	*507	596	-	721	734	-	-	-	-	-	-	-	-
Stage 2	*878	716	-	704	591	-	-	-	-	-	-	-	-
Platoon blocked, %	1	1		1	1	1		-	-	1	1	-	-
Mov Cap-1 Maneuver	*525	362	729	479	371	*856	815	-	-	*999	999	-	-
Mov Cap-2 Maneuver	*525	362	-	479	371	-	-	-	-	-	-	-	-
Stage 1	*493	570	-	701	714	-	-	-	-	-	-	-	-
Stage 2	*812	696	-	617	566	-	-	-	-	-	-	-	-

Approach	EB		WB		NB		SB	
HCM Control Delay, s	10.8		11.7		0.5		1	
HCM LOS	B		B					

Minor Lane/Major Mvmt	NBL	NBT	NBR	EBLn1	WBLn1	SBL	SBT	SBR
Capacity (veh/h)	815	-	-	680	617	999	-	-
HCM Lane V/C Ratio	0.028	-	-	0.09	0.132	0.044	-	-
HCM Control Delay (s)	9.5	-	-	10.8	11.7	8.8	-	-
HCM Lane LOS	A	-	-	B	B	A	-	-
HCM 95th %tile Q(veh)	0.1	-	-	0.3	0.5	0.1	-	-

Notes
 ~: Volume exceeds capacity \$: Delay exceeds 300s +: Computation Not Defined *: All major volume in platoon

HCM 6th TWSC
3: Access A & Dynamic Drive

Background Traffic Conditions
Year 2024 - PM Peak Hour

Intersection												
Int Delay, s/veh	1.6											
Movement	EBL	EBT	EBR	WBL	WBT	WBR	NBL	NBT	NBR	SBL	SBT	SBR
Lane Configurations	↕			↕			↕			↕		
Traffic Vol, veh/h	0	82	1	2	42	1	3	1	12	3	1	7
Future Vol, veh/h	0	82	1	2	42	1	3	1	12	3	1	7
Conflicting Peds, #/hr	0	0	0	0	0	0	0	0	0	0	0	0
Sign Control	Free	Free	Free	Free	Free	Free	Stop	Stop	Stop	Stop	Stop	Stop
RT Channelized	-	-	None	-	-	None	-	-	None	-	-	None
Storage Length	-	-	-	-	-	-	-	-	-	-	-	-
Veh in Median Storage, #	-	0	-	-	0	-	-	0	-	-	0	-
Grade, %	-	0	-	-	0	-	-	0	-	-	0	-
Peak Hour Factor	92	92	92	92	92	92	92	92	92	92	92	92
Heavy Vehicles, %	2	2	2	2	2	2	2	2	2	2	2	2
Mvmt Flow	0	89	1	2	46	1	3	1	13	3	1	8

Major/Minor	Major1			Major2			Minor1			Minor2		
Conflicting Flow All	47	0	0	90	0	0	145	141	90	148	141	47
Stage 1	-	-	-	-	-	-	90	90	-	51	51	-
Stage 2	-	-	-	-	-	-	55	51	-	97	90	-
Critical Hdwy	4.12	-	-	4.12	-	-	7.12	6.52	6.22	7.12	6.52	6.22
Critical Hdwy Stg 1	-	-	-	-	-	-	6.12	5.52	-	6.12	5.52	-
Critical Hdwy Stg 2	-	-	-	-	-	-	6.12	5.52	-	6.12	5.52	-
Follow-up Hdwy	2.218	-	-	2.218	-	-	3.518	4.018	3.318	3.518	4.018	3.318
Pot Cap-1 Maneuver	1560	-	-	1505	-	-	824	750	968	820	750	1022
Stage 1	-	-	-	-	-	-	917	820	-	962	852	-
Stage 2	-	-	-	-	-	-	957	852	-	910	820	-
Platoon blocked, %	-	-	-	-	-	-	-	-	-	-	-	-
Mov Cap-1 Maneuver	1560	-	-	1505	-	-	817	749	968	808	749	1022
Mov Cap-2 Maneuver	-	-	-	-	-	-	817	749	-	808	749	-
Stage 1	-	-	-	-	-	-	917	820	-	962	851	-
Stage 2	-	-	-	-	-	-	948	851	-	897	820	-

Approach	EB			WB			NB			SB		
HCM Control Delay, s	0			0.3			9			8.9		
HCM LOS							A			A		

Minor Lane/Major Mvmt	NBLn1	EBL	EBT	EBR	WBL	WBT	WBR	SBLn1
Capacity (veh/h)	919	1560	-	-	1505	-	-	925
HCM Lane V/C Ratio	0.019	-	-	-	0.001	-	-	0.013
HCM Control Delay (s)	9	0	-	-	7.4	0	-	8.9
HCM Lane LOS	A	A	-	-	A	A	-	A
HCM 95th %tile Q(veh)	0.1	0	-	-	0	-	-	0

HCM 6th TWSC
4: Research Parkway & Access B

Background Traffic Conditions
Year 2024 - PM Peak Hour

Intersection												
Int Delay, s/veh	0.5											
Movement	EBL	EBT	EBR	WBL	WBT	WBR	NBL	NBT	NBR	SBL	SBT	SBR
Lane Configurations	↘	↑↑↑	↗	↘	↑↑↑	↗			↗			↗
Traffic Vol, veh/h	12	1286	5	6	694	11	0	0	55	0	0	12
Future Vol, veh/h	12	1286	5	6	694	11	0	0	55	0	0	12
Conflicting Peds, #/hr	0	0	0	0	0	0	0	0	0	0	0	0
Sign Control	Free	Free	Free	Free	Free	Free	Stop	Stop	Stop	Stop	Stop	Stop
RT Channelized	-	-	None	-	-	None	-	-	None	-	-	None
Storage Length	115	-	-	210	-	240	-	-	0	-	-	0
Veh in Median Storage, #	-	0	-	-	0	-	-	0	-	-	0	-
Grade, %	-	0	-	-	0	-	-	0	-	-	0	-
Peak Hour Factor	92	92	92	92	92	92	92	92	92	92	92	92
Heavy Vehicles, %	2	2	2	2	2	2	2	2	2	2	2	2
Mvmt Flow	13	1398	5	7	754	12	0	0	60	0	0	13

Major/Minor	Major1			Major2			Minor1			Minor2		
Conflicting Flow All	766	0	0	1403	0	0	-	-	699	-	-	377
Stage 1	-	-	-	-	-	-	-	-	-	-	-	-
Stage 2	-	-	-	-	-	-	-	-	-	-	-	-
Critical Hdwy	5.34	-	-	5.34	-	-	-	-	7.14	-	-	7.14
Critical Hdwy Stg 1	-	-	-	-	-	-	-	-	-	-	-	-
Critical Hdwy Stg 2	-	-	-	-	-	-	-	-	-	-	-	-
Follow-up Hdwy	3.12	-	-	3.12	-	-	-	-	3.92	-	-	3.92
Pot Cap-1 Maneuver	507	-	-	*770	-	-	0	0	*613	0	0	530
Stage 1	-	-	-	-	-	-	0	0	-	0	0	-
Stage 2	-	-	-	-	-	-	0	0	-	0	0	-
Platoon blocked, %		-	-	1	-	-			1			
Mov Cap-1 Maneuver	507	-	-	*770	-	-	-	-	*613	-	-	530
Mov Cap-2 Maneuver	-	-	-	-	-	-	-	-	-	-	-	-
Stage 1	-	-	-	-	-	-	-	-	-	-	-	-
Stage 2	-	-	-	-	-	-	-	-	-	-	-	-

Approach	EB			WB			NB			SB		
HCM Control Delay, s	0.1			0.1			11.5			12		
HCM LOS							B			B		

Minor Lane/Major Mvmt	NBLn1	EBL	EBT	EBR	WBL	WBT	WBR	SBLn1
Capacity (veh/h)	613	507	-	-	* 770	-	-	530
HCM Lane V/C Ratio	0.098	0.026	-	-	0.008	-	-	0.025
HCM Control Delay (s)	11.5	12.3	-	-	9.7	-	-	12
HCM Lane LOS	B	B	-	-	A	-	-	B
HCM 95th %tile Q(veh)	0.3	0.1	-	-	0	-	-	0.1

Notes
 ~: Volume exceeds capacity \$: Delay exceeds 300s +: Computation Not Defined *: All major volume in platoon

Timings
1: Chapel Hills Drive & Research Parkway

Background Traffic Conditions
Year 2042 - AM Peak Hour

Lane Group	EBU	EBL	EBT	EBR	WBU	WBL	WBT	WBR	NBU	NBL	NBT	NBR
Lane Configurations												
Traffic Volume (vph)	2	116	742	81	14	325	1488	276	7	43	200	88
Future Volume (vph)	2	116	742	81	14	325	1488	276	7	43	200	88
Satd. Flow (prot)	0	1770	5085	1583	0	1770	5085	1583	0	1770	3539	1583
Flt Permitted		0.113				0.278				0.535		
Satd. Flow (perm)	0	210	5085	1583	0	518	5085	1583	0	997	3539	1583
Satd. Flow (RTOR)				186				220				186
Lane Group Flow (vph)	0	128	807	88	0	368	1617	300	0	55	217	96
Turn Type	custom	pm+pt	NA	Perm	custom	pm+pt	NA	Perm	custom	pm+pt	NA	Perm
Protected Phases		5	2			1	6			7	4	
Permitted Phases	5	2		2	1	6		6	7	4		4
Detector Phase	5	5	2	2	1	1	6	6	7	7	4	4
Switch Phase												
Minimum Initial (s)	4.0	4.0	4.0	4.0	4.0	4.0	4.0	4.0	4.0	4.0	4.0	4.0
Minimum Split (s)	9.0	9.0	10.5	10.5	9.0	9.0	10.5	10.5	9.0	9.0	10.5	10.5
Total Split (s)	19.0	19.0	52.0	52.0	42.0	42.0	75.0	75.0	11.0	11.0	24.0	24.0
Total Split (%)	13.8%	13.8%	37.7%	37.7%	30.4%	30.4%	54.3%	54.3%	8.0%	8.0%	17.4%	17.4%
Yellow Time (s)	3.0	3.0	4.5	4.5	3.0	3.0	4.5	4.5	3.0	3.0	4.5	4.5
All-Red Time (s)	2.0	2.0	2.0	2.0	2.0	2.0	2.0	2.0	2.0	2.0	2.0	2.0
Lost Time Adjust (s)		0.0	0.0	0.0		0.0	0.0	0.0		0.0	0.0	0.0
Total Lost Time (s)		5.0	6.5	6.5		5.0	6.5	6.5		5.0	6.5	6.5
Lead/Lag	Lead	Lead	Lag	Lag	Lead	Lead	Lag	Lag	Lead	Lead	Lag	Lag
Lead-Lag Optimize?	Yes	Yes	Yes	Yes	Yes	Yes	Yes	Yes	Yes	Yes	Yes	Yes
Recall Mode	None	None	C-Max	C-Max	None	None	C-Max	C-Max	None	None	None	None
Act Effct Green (s)		79.6	68.8	68.8		93.8	78.0	78.0		21.2	13.7	13.7
Actuated g/C Ratio		0.58	0.50	0.50		0.68	0.57	0.57		0.15	0.10	0.10
v/c Ratio		0.57	0.32	0.10		0.71	0.56	0.30		0.30	0.62	0.30
Control Delay		24.8	22.5	0.2		17.5	20.9	5.7		43.8	67.1	2.3
Queue Delay		0.0	0.0	0.0		0.0	0.0	0.0		0.0	0.0	0.0
Total Delay		24.8	22.5	0.2		17.5	20.9	5.7		43.8	67.1	2.3
LOS		C	C	A		B	C	A		D	E	A
Approach Delay			20.9				18.4				46.7	
Approach LOS			C				B				D	
Queue Length 50th (ft)		38	153	0		127	330	32		38	100	0
Queue Length 95th (ft)		92	227	0		194	429	93		72	140	0
Internal Link Dist (ft)			699				709				470	
Turn Bay Length (ft)		405		160		315		185		150		330
Base Capacity (vph)		286	2535	882		688	2874	990		186	448	363
Starvation Cap Reductn		0	0	0		0	0	0		0	0	0
Spillback Cap Reductn		0	0	0		0	0	0		0	0	0
Storage Cap Reductn		0	0	0		0	0	0		0	0	0
Reduced v/c Ratio		0.45	0.32	0.10		0.53	0.56	0.30		0.30	0.48	0.26

Intersection Summary

Cycle Length: 138
 Actuated Cycle Length: 138
 Offset: 10 (7%), Referenced to phase 2:EBTL and 6:WBTL, Start of Green
 Natural Cycle: 60
 Control Type: Actuated-Coordinated

Timings
1: Chapel Hills Drive & Research Parkway

Background Traffic Conditions
Year 2042 - AM Peak Hour



Lane Group	SBL	SBT	SBR
Lane Configurations	↘	↑↑↑	↗
Traffic Volume (vph)	150	320	92
Future Volume (vph)	150	320	92
Satd. Flow (prot)	1770	5085	1583
Flt Permitted	0.402		
Satd. Flow (perm)	749	5085	1583
Satd. Flow (RTOR)			146
Lane Group Flow (vph)	163	348	100
Turn Type	pm+pt	NA	Perm
Protected Phases	3	8	
Permitted Phases	8		8
Detector Phase	3	8	8
Switch Phase			
Minimum Initial (s)	4.0	4.0	4.0
Minimum Split (s)	9.0	10.5	10.5
Total Split (s)	20.0	33.0	33.0
Total Split (%)	14.5%	23.9%	23.9%
Yellow Time (s)	3.0	4.5	4.5
All-Red Time (s)	2.0	2.0	2.0
Lost Time Adjust (s)	0.0	0.0	0.0
Total Lost Time (s)	5.0	6.5	6.5
Lead/Lag	Lead	Lag	Lag
Lead-Lag Optimize?	Yes	Yes	Yes
Recall Mode	None	None	None
Act Effct Green (s)	34.1	23.8	23.8
Actuated g/C Ratio	0.25	0.17	0.17
v/c Ratio	0.57	0.40	0.25
Control Delay	50.3	52.1	3.3
Queue Delay	0.0	0.0	0.0
Total Delay	50.3	52.1	3.3
LOS	D	D	A
Approach Delay		43.6	
Approach LOS		D	
Queue Length 50th (ft)	121	104	0
Queue Length 95th (ft)	182	134	15
Internal Link Dist (ft)		998	
Turn Bay Length (ft)	195		185
Base Capacity (vph)	296	976	421
Starvation Cap Reductn	0	0	0
Spillback Cap Reductn	0	0	0
Storage Cap Reductn	0	0	0
Reduced v/c Ratio	0.55	0.36	0.24









Intersection Summary

Timings
 1: Chapel Hills Drive & Research Parkway

Background Traffic Conditions
 Year 2042 - AM Peak Hour

Maximum v/c Ratio: 0.71	Intersection Signal Delay: 25.0	Intersection LOS: C
Intersection Capacity Utilization 68.3%	ICU Level of Service C	
Analysis Period (min) 15		

Splits and Phases: 1: Chapel Hills Drive & Research Parkway

 Ø1	 Ø2 (R)	 Ø3	 Ø4
42 s	52 s	20 s	24 s
 Ø5	 Ø6 (R)	 Ø7	 Ø8
19 s	75 s	11 s	33 s

HCM 6th TWSC
 2: Chapel Hills Drive & Highland Ridge Heights/Dynamic Drive

Background Traffic Conditions
 Year 2042 - AM Peak Hour

Intersection													
Int Delay, s/veh	3.5												
Movement	EBL	EBT	EBR	WBL	WBT	WBR	NBL	NBT	NBR	SBU	SBL	SBT	SBR
Lane Configurations	↕			↕			↕ ↕ ↕		↕	↕ ↕ ↕			↕
Traffic Vol, veh/h	2	4	20	49	5	123	58	432	29	9	85	500	11
Future Vol, veh/h	2	4	20	49	5	123	58	432	29	9	85	500	11
Conflicting Peds, #/hr	0	0	0	0	0	0	0	0	0	0	0	0	0
Sign Control	Stop	Stop	Stop	Stop	Stop	Stop	Free	Free	Free	Free	Free	Free	Free
RT Channelized	-	-	None	-	-	None	-	-	None	-	-	-	None
Storage Length	-	-	-	-	-	-	240	-	150	-	230	-	175
Veh in Median Storage, #	-	0	-	-	0	-	-	0	-	-	-	0	-
Grade, %	-	0	-	-	0	-	-	0	-	-	-	0	-
Peak Hour Factor	92	92	92	92	92	92	92	92	92	92	92	92	92
Heavy Vehicles, %	2	2	2	2	2	2	2	2	2	2	2	2	2
Mvmt Flow	2	4	22	53	5	134	63	470	32	10	92	543	12

Major/Minor	Minor2		Minor1		Major1		Major2						
Conflicting Flow All	1064	1375	272	1019	1355	235	555	0	0	343	502	0	0
Stage 1	747	747	-	596	596	-	-	-	-	-	-	-	-
Stage 2	317	628	-	423	759	-	-	-	-	-	-	-	-
Critical Hdwy	6.44	6.54	7.14	6.44	6.54	7.14	5.34	-	-	5.64	5.34	-	-
Critical Hdwy Stg 1	7.34	5.54	-	7.34	5.54	-	-	-	-	-	-	-	-
Critical Hdwy Stg 2	6.74	5.54	-	6.74	5.54	-	-	-	-	-	-	-	-
Follow-up Hdwy	3.82	4.02	3.92	3.82	4.02	3.92	3.12	-	-	2.32	3.12	-	-
Pot Cap-1 Maneuver	*365	217	619	390	223	*818	638	-	-	*1382	1011	-	-
Stage 1	*298	418	-	698	707	-	-	-	-	-	-	-	-
Stage 2	*839	682	-	530	413	-	-	-	-	-	-	-	-
Platoon blocked, %	1	1	-	1	1	1	-	-	-	1	1	-	-
Mov Cap-1 Maneuver	*255	176	619	316	181	*818	638	-	-	*1025	1025	-	-
Mov Cap-2 Maneuver	*255	176	-	316	181	-	-	-	-	-	-	-	-
Stage 1	*268	376	-	629	637	-	-	-	-	-	-	-	-
Stage 2	*627	615	-	455	372	-	-	-	-	-	-	-	-

Approach	EB		WB		NB		SB	
HCM Control Delay, s	14.4		15.6		1.3		1.4	
HCM LOS	B		C					

Minor Lane/Major Mvmt	NBL	NBT	NBR	EBLn1	WBLn1	SBL	SBT	SBR
Capacity (veh/h)	638	-	-	413	531	1025	-	-
HCM Lane V/C Ratio	0.099	-	-	0.068	0.362	0.1	-	-
HCM Control Delay (s)	11.3	-	-	14.4	15.6	8.9	-	-
HCM Lane LOS	B	-	-	B	C	A	-	-
HCM 95th %tile Q(veh)	0.3	-	-	0.2	1.6	0.3	-	-

Notes
 ~: Volume exceeds capacity \$: Delay exceeds 300s +: Computation Not Defined *: All major volume in platoon

HCM 6th TWSC
3: Access A & Dynamic Drive

Background Traffic Conditions
Year 2042 - AM Peak Hour

Intersection												
Int Delay, s/veh	0.8											
Movement	EBL	EBT	EBR	WBL	WBT	WBR	NBL	NBT	NBR	SBL	SBT	SBR
Lane Configurations	↕			↕			↕			↕		
Traffic Vol, veh/h	7	58	23	14	182	0	4	0	2	0	2	0
Future Vol, veh/h	7	58	23	14	182	0	4	0	2	0	2	0
Conflicting Peds, #/hr	0	0	0	0	0	0	0	0	0	0	0	0
Sign Control	Free	Free	Free	Free	Free	Free	Stop	Stop	Stop	Stop	Stop	Stop
RT Channelized	-	-	None	-	-	None	-	-	None	-	-	None
Storage Length	-	-	-	-	-	-	-	-	-	-	-	-
Veh in Median Storage, #	-	0	-	-	0	-	-	0	-	-	0	-
Grade, %	-	0	-	-	0	-	-	0	-	-	0	-
Peak Hour Factor	92	92	92	92	92	92	92	92	92	92	92	92
Heavy Vehicles, %	2	2	2	2	2	2	2	2	2	2	2	2
Mvmt Flow	8	63	25	15	198	0	4	0	2	0	2	0

Major/Minor	Major1			Major2			Minor1			Minor2		
Conflicting Flow All	198	0	0	88	0	0	321	320	76	321	332	198
Stage 1	-	-	-	-	-	-	92	92	-	228	228	-
Stage 2	-	-	-	-	-	-	229	228	-	93	104	-
Critical Hdwy	4.12	-	-	4.12	-	-	7.12	6.52	6.22	7.12	6.52	6.22
Critical Hdwy Stg 1	-	-	-	-	-	-	6.12	5.52	-	6.12	5.52	-
Critical Hdwy Stg 2	-	-	-	-	-	-	6.12	5.52	-	6.12	5.52	-
Follow-up Hdwy	2.218	-	-	2.218	-	-	3.518	4.018	3.318	3.518	4.018	3.318
Pot Cap-1 Maneuver	1375	-	-	1508	-	-	632	597	985	632	588	843
Stage 1	-	-	-	-	-	-	915	819	-	775	715	-
Stage 2	-	-	-	-	-	-	774	715	-	914	809	-
Platoon blocked, %	-	-	-	-	-	-	-	-	-	-	-	-
Mov Cap-1 Maneuver	1375	-	-	1508	-	-	622	587	985	623	578	843
Mov Cap-2 Maneuver	-	-	-	-	-	-	622	587	-	623	578	-
Stage 1	-	-	-	-	-	-	910	814	-	770	707	-
Stage 2	-	-	-	-	-	-	763	707	-	907	804	-

Approach	EB			WB			NB			SB		
HCM Control Delay, s	0.6			0.5			10.1			11.3		
HCM LOS							B			B		

Minor Lane/Major Mvmt	NBLn1	EBL	EBT	EBR	WBL	WBT	WBR	SBLn1
Capacity (veh/h)	709	1375	-	-	1508	-	-	578
HCM Lane V/C Ratio	0.009	0.006	-	-	0.01	-	-	0.004
HCM Control Delay (s)	10.1	7.6	0	-	7.4	0	-	11.3
HCM Lane LOS	B	A	A	-	A	A	-	B
HCM 95th %tile Q(veh)	0	0	-	-	0	-	-	0

HCM 6th TWSC
4: Research Parkway & Access B

Background Traffic Conditions
Year 2042 - AM Peak Hour

Intersection												
Int Delay, s/veh	1.7											
Movement	EBL	EBT	EBR	WBL	WBT	WBR	NBL	NBT	NBR	SBL	SBT	SBR
Lane Configurations	↘	↑↑↑	↗	↘	↑↑↑	↗			↗			↗
Traffic Vol, veh/h	45	916	29	67	2079	69	0	0	18	0	0	14
Future Vol, veh/h	45	916	29	67	2079	69	0	0	18	0	0	14
Conflicting Peds, #/hr	0	0	0	0	0	0	0	0	0	0	0	0
Sign Control	Free	Free	Free	Free	Free	Free	Stop	Stop	Stop	Stop	Stop	Stop
RT Channelized	-	-	None	-	-	None	-	-	None	-	-	None
Storage Length	115	-	-	210	-	240	-	-	0	-	-	0
Veh in Median Storage, #	-	0	-	-	0	-	-	0	-	-	0	-
Grade, %	-	0	-	-	0	-	-	0	-	-	0	-
Peak Hour Factor	92	92	92	92	92	92	92	92	92	92	92	92
Heavy Vehicles, %	2	2	2	2	2	2	2	2	2	2	2	2
Mvmt Flow	49	996	32	73	2260	75	0	0	20	0	0	15

Major/Minor	Major1			Major2			Minor1			Minor2		
Conflicting Flow All	2335	0	0	1028	0	0	-	-	498	-	-	1130
Stage 1	-	-	-	-	-	-	-	-	-	-	-	-
Stage 2	-	-	-	-	-	-	-	-	-	-	-	-
Critical Hdwy	5.34	-	-	5.34	-	-	-	-	7.14	-	-	7.14
Critical Hdwy Stg 1	-	-	-	-	-	-	-	-	-	-	-	-
Critical Hdwy Stg 2	-	-	-	-	-	-	-	-	-	-	-	-
Follow-up Hdwy	3.12	-	-	3.12	-	-	-	-	3.92	-	-	3.92
Pot Cap-1 Maneuver	84	-	-	*888	-	-	0	0	*707	0	0	170
Stage 1	-	-	-	-	-	-	0	0	-	0	0	-
Stage 2	-	-	-	-	-	-	0	0	-	0	0	-
Platoon blocked, %		-	-	1	-	-			1			
Mov Cap-1 Maneuver	84	-	-	*888	-	-	-	-	*707	-	-	170
Mov Cap-2 Maneuver	-	-	-	-	-	-	-	-	-	-	-	-
Stage 1	-	-	-	-	-	-	-	-	-	-	-	-
Stage 2	-	-	-	-	-	-	-	-	-	-	-	-





















Approach	EB			WB			NB			SB		
HCM Control Delay, s	4.3			0.3			10.2			28.2		
HCM LOS							B			D		

Minor Lane/Major Mvmt	NBLn1	EBL	EBT	EBR	WBL	WBT	WBR	SBLn1
Capacity (veh/h)	707	84	-	-	* 888	-	-	170
HCM Lane V/C Ratio	0.028	0.582	-	-	0.082	-	-	0.09
HCM Control Delay (s)	10.2	95.5	-	-	9.4	-	-	28.2
HCM Lane LOS	B	F	-	-	A	-	-	D
HCM 95th %tile Q(veh)	0.1	2.6	-	-	0.3	-	-	0.3

Notes
 ~: Volume exceeds capacity \$: Delay exceeds 300s +: Computation Not Defined *: All major volume in platoon

Timings
1: Chapel Hills Drive & Research Parkway

Background Traffic Conditions
Year 2042 - PM Peak Hour

												
Lane Group	EBU	EBL	EBT	EBR	WBU	WBL	WBT	WBR	NBU	NBL	NBT	NBR
Lane Configurations												
Traffic Volume (vph)	33	204	1687	67	42	316	833	98	11	70	327	293
Future Volume (vph)	33	204	1687	67	42	316	833	98	11	70	327	293
Satd. Flow (prot)	0	1770	5085	1583	0	1770	5085	1583	0	1770	3539	1583
Flt Permitted		0.303				0.063				0.484		
Satd. Flow (perm)	0	564	5085	1583	0	117	5085	1583	0	902	3539	1583
Satd. Flow (RTOR)				186				146				232
Lane Group Flow (vph)	0	258	1834	73	0	389	905	107	0	88	355	318
Turn Type	custom	pm+pt	NA	Perm	custom	pm+pt	NA	Perm	custom	pm+pt	NA	Perm
Protected Phases		5	2			1	6			7	4	
Permitted Phases	5	2		2	1	6		6	7	4		4
Detector Phase	5	5	2	2	1	1	6	6	7	7	4	4
Switch Phase												
Minimum Initial (s)	4.0	4.0	4.0	4.0	4.0	4.0	4.0	4.0	4.0	4.0	4.0	4.0
Minimum Split (s)	9.0	9.0	10.5	10.5	9.0	9.0	10.5	10.5	9.0	9.0	10.5	10.5
Total Split (s)	23.0	23.0	64.0	64.0	33.0	33.0	74.0	74.0	12.0	12.0	23.0	23.0
Total Split (%)	16.7%	16.7%	46.4%	46.4%	23.9%	23.9%	53.6%	53.6%	8.7%	8.7%	16.7%	16.7%
Yellow Time (s)	3.0	3.0	4.5	4.5	3.0	3.0	4.5	4.5	3.0	3.0	4.5	4.5
All-Red Time (s)	2.0	2.0	2.0	2.0	2.0	2.0	2.0	2.0	2.0	2.0	2.0	2.0
Lost Time Adjust (s)		0.0	0.0	0.0		0.0	0.0	0.0		0.0	0.0	0.0
Total Lost Time (s)		5.0	6.5	6.5		5.0	6.5	6.5		5.0	6.5	6.5
Lead/Lag	Lead	Lead	Lag	Lag	Lead	Lead	Lag	Lag	Lead	Lead	Lag	Lag
Lead-Lag Optimize?	Yes	Yes	Yes	Yes	Yes	Yes	Yes	Yes	Yes	Yes	Yes	Yes
Recall Mode	None	None	C-Max	C-Max	None	None	C-Max	C-Max	None	None	None	None
Act Effct Green (s)		73.3	58.5	58.5		92.3	72.5	72.5		24.7	16.2	16.2
Actuated g/C Ratio		0.53	0.42	0.42		0.67	0.53	0.53		0.18	0.12	0.12
v/c Ratio		0.62	0.85	0.09		0.96	0.34	0.12		0.43	0.86	0.82
Control Delay		18.3	40.9	0.2		76.9	19.8	1.2		48.1	79.6	34.2
Queue Delay		0.0	0.0	0.0		0.0	0.0	0.0		0.0	0.0	0.0
Total Delay		18.3	40.9	0.2		76.9	19.8	1.2		48.1	79.6	34.2
LOS		B	D	A		E	B	A		D	E	C
Approach Delay			36.8				34.2				57.0	
Approach LOS			D				C				E	
Queue Length 50th (ft)		84	544	0		293	167	0		62	166	74
Queue Length 95th (ft)		123	612	0		#496	212	13		109	#245	#222
Internal Link Dist (ft)			699				709				470	
Turn Bay Length (ft)		405		160		315		185		150		330
Base Capacity (vph)		476	2153	778		413	2670	900		205	423	393
Starvation Cap Reductn		0	0	0		0	0	0		0	0	0
Spillback Cap Reductn		0	0	0		0	0	0		0	0	0
Storage Cap Reductn		0	0	0		0	0	0		0	0	0
Reduced v/c Ratio		0.54	0.85	0.09		0.94	0.34	0.12		0.43	0.84	0.81

Intersection Summary

Cycle Length: 138
 Actuated Cycle Length: 138
 Offset: 10 (7%), Referenced to phase 2:EBTL and 6:WBTL, Start of Green
 Natural Cycle: 90
 Control Type: Actuated-Coordinated

Timings
1: Chapel Hills Drive & Research Parkway

Background Traffic Conditions
Year 2042 - PM Peak Hour









Lane Group	SBL	SBT	SBR
Lane Configurations	↘	↑↑↑	↗
Traffic Volume (vph)	210	412	79
Future Volume (vph)	210	412	79
Satd. Flow (prot)	1770	5085	1583
Flt Permitted	0.219		
Satd. Flow (perm)	408	5085	1583
Satd. Flow (RTOR)			146
Lane Group Flow (vph)	228	448	86
Turn Type	pm+pt	NA	Perm
Protected Phases	3	8	
Permitted Phases	8		8
Detector Phase	3	8	8
Switch Phase			
Minimum Initial (s)	4.0	4.0	4.0
Minimum Split (s)	9.0	10.5	10.5
Total Split (s)	18.0	29.0	29.0
Total Split (%)	13.0%	21.0%	21.0%
Yellow Time (s)	3.0	4.5	4.5
All-Red Time (s)	2.0	2.0	2.0
Lost Time Adjust (s)	0.0	0.0	0.0
Total Lost Time (s)	5.0	6.5	6.5
Lead/Lag	Lead	Lag	Lag
Lead-Lag Optimize?	Yes	Yes	Yes
Recall Mode	None	None	None
Act Effct Green (s)	35.7	22.2	22.2
Actuated g/C Ratio	0.26	0.16	0.16
v/c Ratio	0.98	0.55	0.23
Control Delay	99.2	56.1	1.5
Queue Delay	0.0	0.0	0.0
Total Delay	99.2	56.1	1.5
LOS	F	E	A
Approach Delay		62.8	
Approach LOS		E	
Queue Length 50th (ft)	175	136	0
Queue Length 95th (ft)	#312	176	2
Internal Link Dist (ft)		998	
Turn Bay Length (ft)	195		185
Base Capacity (vph)	233	829	380
Starvation Cap Reductn	0	0	0
Spillback Cap Reductn	0	0	0
Storage Cap Reductn	0	0	0
Reduced v/c Ratio	0.98	0.54	0.23
Intersection Summary			

Timings
 1: Chapel Hills Drive & Research Parkway

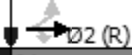
Background Traffic Conditions
 Year 2042 - PM Peak Hour

Maximum v/c Ratio: 0.98	
Intersection Signal Delay: 43.0	Intersection LOS: D
Intersection Capacity Utilization 101.4%	ICU Level of Service G
Analysis Period (min) 15	
# 95th percentile volume exceeds capacity, queue may be longer.	
Queue shown is maximum after two cycles.	

Splits and Phases: 1: Chapel Hills Drive & Research Parkway

 Ø1	 Ø2 (R)	 Ø3	 Ø4
33 s	64 s	18 s	23 s
 Ø5	 Ø6 (R)	 Ø7	 Ø8
23 s	74 s	12 s	29 s

HCM 6th TWSC
 2: Chapel Hills Drive & Highland Ridge Heights/Dynamic Drive

Background Traffic Conditions
 Year 2042 - PM Peak Hour

Intersection													
Int Delay, s/veh	3												
Movement	EBL	EBT	EBR	WBL	WBT	WBR	NBL	NBT	NBR	SBU	SBL	SBT	SBR
Lane Configurations		↕			↕		↙	↑↑↑	↘		↘	↑↑↑	↙
Traffic Vol, veh/h	0	6	89	62	0	65	36	591	40	9	60	500	13
Future Vol, veh/h	0	6	89	62	0	65	36	591	40	9	60	500	13
Conflicting Peds, #/hr	0	0	0	0	0	0	0	0	0	0	0	0	0
Sign Control	Stop	Stop	Stop	Stop	Stop	Stop	Free	Free	Free	Free	Free	Free	Free
RT Channelized	-	-	None	-	-	None	-	-	None	-	-	-	None
Storage Length	-	-	-	-	-	-	240	-	150	-	230	-	175
Veh in Median Storage, #	-	0	-	-	0	-	-	0	-	-	-	0	-
Grade, %	-	0	-	-	0	-	-	0	-	-	-	0	-
Peak Hour Factor	92	92	92	92	92	92	92	92	92	92	92	92	92
Heavy Vehicles, %	2	2	2	2	2	2	2	2	2	2	2	2	2
Mvmt Flow	0	7	97	67	0	71	39	642	43	10	65	543	14

Major/Minor	Minor2		Minor1		Major1		Major2						
Conflicting Flow All	1028	1456	272	1091	1427	321	557	0	0	469	685	0	0
Stage 1	693	693	-	720	720	-	-	-	-	-	-	-	-
Stage 2	335	763	-	371	707	-	-	-	-	-	-	-	-
Critical Hdwy	6.44	6.54	7.14	6.44	6.54	7.14	5.34	-	-	5.64	5.34	-	-
Critical Hdwy Stg 1	7.34	5.54	-	7.34	5.54	-	-	-	-	-	-	-	-
Critical Hdwy Stg 2	6.74	5.54	-	6.74	5.54	-	-	-	-	-	-	-	-
Follow-up Hdwy	3.82	4.02	3.92	3.82	4.02	3.92	3.12	-	-	2.32	3.12	-	-
Pot Cap-1 Maneuver	*470	229	619	426	239	*780	637	-	-	*1319	966	-	-
Stage 1	*324	443	-	736	721	-	-	-	-	-	-	-	-
Stage 2	*801	686	-	569	436	-	-	-	-	-	-	-	-
Platoon blocked, %	1	1		1	1	1		-	-	1	1	-	-
Mov Cap-1 Maneuver	*384	199	619	315	207	*780	637	-	-	*992	992	-	-
Mov Cap-2 Maneuver	*384	199	-	315	207	-	-	-	-	-	-	-	-
Stage 1	*304	409	-	691	677	-	-	-	-	-	-	-	-
Stage 2	*683	644	-	437	403	-	-	-	-	-	-	-	-

Approach	EB	WB	NB	SB
HCM Control Delay, s	13.1	16.4	0.6	1.1
HCM LOS	B	C		

Minor Lane/Major Mvmt	NBL	NBT	NBR	EBLn1	WBLn1	SBL	SBT	SBR
Capacity (veh/h)	637	-	-	546	453	992	-	-
HCM Lane V/C Ratio	0.061	-	-	0.189	0.305	0.076	-	-
HCM Control Delay (s)	11	-	-	13.1	16.4	8.9	-	-
HCM Lane LOS	B	-	-	B	C	A	-	-
HCM 95th %tile Q(veh)	0.2	-	-	0.7	1.3	0.2	-	-

Notes
 ~: Volume exceeds capacity \$: Delay exceeds 300s +: Computation Not Defined *: All major volume in platoon

HCM 6th TWSC
3: Access A & Dynamic Drive

Background Traffic Conditions
Year 2042 - PM Peak Hour

Intersection												
Int Delay, s/veh	1.8											
Movement	EBL	EBT	EBR	WBL	WBT	WBR	NBL	NBT	NBR	SBL	SBT	SBR
Lane Configurations	↕			↕			↕			↕		
Traffic Vol, veh/h	0	139	2	5	72	2	5	2	20	5	2	13
Future Vol, veh/h	0	139	2	5	72	2	5	2	20	5	2	13
Conflicting Peds, #/hr	0	0	0	0	0	0	0	0	0	0	0	0
Sign Control	Free	Free	Free	Free	Free	Free	Stop	Stop	Stop	Stop	Stop	Stop
RT Channelized	-	-	None	-	-	None	-	-	None	-	-	None
Storage Length	-	-	-	-	-	-	-	-	-	-	-	-
Veh in Median Storage, #	-	0	-	-	0	-	-	0	-	-	0	-
Grade, %	-	0	-	-	0	-	-	0	-	-	0	-
Peak Hour Factor	92	92	92	92	92	92	92	92	92	92	92	92
Heavy Vehicles, %	2	2	2	2	2	2	2	2	2	2	2	2
Mvmt Flow	0	151	2	5	78	2	5	2	22	5	2	14

Major/Minor	Major1			Major2			Minor1			Minor2		
Conflicting Flow All	80	0	0	153	0	0	249	242	152	253	242	79
Stage 1	-	-	-	-	-	-	152	152	-	89	89	-
Stage 2	-	-	-	-	-	-	97	90	-	164	153	-
Critical Hdwy	4.12	-	-	4.12	-	-	7.12	6.52	6.22	7.12	6.52	6.22
Critical Hdwy Stg 1	-	-	-	-	-	-	6.12	5.52	-	6.12	5.52	-
Critical Hdwy Stg 2	-	-	-	-	-	-	6.12	5.52	-	6.12	5.52	-
Follow-up Hdwy	2.218	-	-	2.218	-	-	3.518	4.018	3.318	3.518	4.018	3.318
Pot Cap-1 Maneuver	1518	-	-	1428	-	-	705	660	894	700	660	981
Stage 1	-	-	-	-	-	-	850	772	-	918	821	-
Stage 2	-	-	-	-	-	-	910	820	-	838	771	-
Platoon blocked, %	-	-	-	-	-	-	-	-	-	-	-	-
Mov Cap-1 Maneuver	1518	-	-	1428	-	-	691	657	894	679	657	981
Mov Cap-2 Maneuver	-	-	-	-	-	-	691	657	-	679	657	-
Stage 1	-	-	-	-	-	-	850	772	-	918	818	-
Stage 2	-	-	-	-	-	-	891	817	-	815	771	-

Approach	EB			WB			NB			SB		
HCM Control Delay, s	0			0.5			9.5			9.4		
HCM LOS							A			A		

Minor Lane/Major Mvmt	NBLn1	EBL	EBT	EBR	WBL	WBT	WBR	SBLn1
Capacity (veh/h)	827	1518	-	-	1428	-	-	845
HCM Lane V/C Ratio	0.035	-	-	-	0.004	-	-	0.026
HCM Control Delay (s)	9.5	0	-	-	7.5	0	-	9.4
HCM Lane LOS	A	A	-	-	A	A	-	A
HCM 95th %tile Q(veh)	0.1	0	-	-	0	-	-	0.1

HCM 6th TWSC
4: Research Parkway & Access B

Background Traffic Conditions
Year 2042 - PM Peak Hour

Intersection												
Int Delay, s/veh	0.7											
Movement	EBL	EBT	EBR	WBL	WBT	WBR	NBL	NBT	NBR	SBL	SBT	SBR
Lane Configurations	↘	↑↑↑	↗	↘	↑↑↑	↗			↗			↗
Traffic Vol, veh/h	20	2189	9	11	1181	18	0	0	94	0	0	20
Future Vol, veh/h	20	2189	9	11	1181	18	0	0	94	0	0	20
Conflicting Peds, #/hr	0	0	0	0	0	0	0	0	0	0	0	0
Sign Control	Free	Free	Free	Free	Free	Free	Stop	Stop	Stop	Stop	Stop	Stop
RT Channelized	-	-	None	-	-	None	-	-	None	-	-	None
Storage Length	115	-	-	210	-	240	-	-	0	-	-	0
Veh in Median Storage, #	-	0	-	-	0	-	-	0	-	-	0	-
Grade, %	-	0	-	-	0	-	-	0	-	-	0	-
Peak Hour Factor	92	92	92	92	92	92	92	92	92	92	92	92
Heavy Vehicles, %	2	2	2	2	2	2	2	2	2	2	2	2
Mvmt Flow	22	2379	10	12	1284	20	0	0	102	0	0	22

Major/Minor	Major1		Major2		Minor1		Minor2					
Conflicting Flow All	1304	0	0	2389	0	0	-	-	1190	-	-	642
Stage 1	-	-	-	-	-	-	-	-	-	-	-	-
Stage 2	-	-	-	-	-	-	-	-	-	-	-	-
Critical Hdwy	5.34	-	-	5.34	-	-	-	-	7.14	-	-	7.14
Critical Hdwy Stg 1	-	-	-	-	-	-	-	-	-	-	-	-
Critical Hdwy Stg 2	-	-	-	-	-	-	-	-	-	-	-	-
Follow-up Hdwy	3.12	-	-	3.12	-	-	-	-	3.92	-	-	3.92
Pot Cap-1 Maneuver	278	-	-	*510	-	-	0	0	*406	0	0	357
Stage 1	-	-	-	-	-	-	0	0	-	0	0	-
Stage 2	-	-	-	-	-	-	0	0	-	0	0	-
Platoon blocked, %		-	-	1	-	-			1			
Mov Cap-1 Maneuver	278	-	-	*510	-	-	-	-	*406	-	-	357
Mov Cap-2 Maneuver	-	-	-	-	-	-	-	-	-	-	-	-
Stage 1	-	-	-	-	-	-	-	-	-	-	-	-
Stage 2	-	-	-	-	-	-	-	-	-	-	-	-

Approach	EB		WB		NB		SB	
HCM Control Delay, s	0.2		0.1		16.8		15.7	
HCM LOS					C		C	

Minor Lane/Major Mvmt	NBLn1	EBL	EBT	EBR	WBL	WBT	WBR	SBLn1
Capacity (veh/h)	406	278	-	-	* 510	-	-	357
HCM Lane V/C Ratio	0.252	0.078	-	-	0.023	-	-	0.061
HCM Control Delay (s)	16.8	19	-	-	12.2	-	-	15.7
HCM Lane LOS	C	C	-	-	B	-	-	C
HCM 95th %tile Q(veh)	1	0.3	-	-	0.1	-	-	0.2

Notes
 ~: Volume exceeds capacity \$: Delay exceeds 300s +: Computation Not Defined *: All major volume in platoon

Timings
1: Chapel Hills Drive & Research Parkway

Total Traffic Conditions
Year 2024 - AM Peak Hour

Lane Group	EBU	EBL	EBT	EBR	WBU	WBL	WBT	WBR	NBU	NBL	NBT	NBR
Lane Configurations												
Traffic Volume (vph)	1	68	440	48	20	199	886	166	4	25	120	55
Future Volume (vph)	1	68	440	48	20	199	886	166	4	25	120	55
Satd. Flow (prot)	0	1770	5085	1583	0	1770	5085	1583	0	1770	3539	1583
Flt Permitted		0.283				0.442				0.615		
Satd. Flow (perm)	0	527	5085	1583	0	823	5085	1583	0	1146	3539	1583
Satd. Flow (RTOR)				107				180				107
Lane Group Flow (vph)	0	75	478	52	0	238	963	180	0	31	130	60
Turn Type	custom	pm+pt	NA	Perm	custom	pm+pt	NA	Perm	custom	pm+pt	NA	Perm
Protected Phases		5	2			1	6			7	4	
Permitted Phases	5	2		2	1	6		6	7	4		4
Detector Phase	5	5	2	2	1	1	6	6	7	7	4	4
Switch Phase												
Minimum Initial (s)	4.0	4.0	4.0	4.0	4.0	4.0	4.0	4.0	4.0	4.0	4.0	4.0
Minimum Split (s)	9.0	9.0	10.5	10.5	9.0	9.0	10.5	10.5	9.0	9.0	10.5	10.5
Total Split (s)	14.0	14.0	63.0	63.0	14.0	14.0	63.0	63.0	15.0	15.0	46.0	46.0
Total Split (%)	10.1%	10.1%	45.7%	45.7%	10.1%	10.1%	45.7%	45.7%	10.9%	10.9%	33.3%	33.3%
Yellow Time (s)	3.0	3.0	4.5	4.5	3.0	3.0	4.5	4.5	3.0	3.0	4.5	4.5
All-Red Time (s)	2.0	2.0	2.0	2.0	2.0	2.0	2.0	2.0	2.0	2.0	2.0	2.0
Lost Time Adjust (s)		0.0	0.0	0.0		0.0	0.0	0.0		0.0	0.0	0.0
Total Lost Time (s)		5.0	6.5	6.5		5.0	6.5	6.5		5.0	6.5	6.5
Lead/Lag	Lead	Lead	Lag	Lag	Lead	Lead	Lag	Lag	Lead	Lead	Lag	Lag
Lead-Lag Optimize?	Yes	Yes	Yes	Yes	Yes	Yes	Yes	Yes	Yes	Yes	Yes	Yes
Recall Mode	None	None	C-Max	C-Max	None	None	C-Max	C-Max	None	None	None	None
Act Effct Green (s)		92.2	83.6	83.6		100.9	89.9	89.9		19.5	10.5	10.5
Actuated g/C Ratio		0.67	0.61	0.61		0.73	0.65	0.65		0.14	0.08	0.08
v/c Ratio		0.18	0.16	0.05		0.35	0.29	0.16		0.16	0.48	0.27
Control Delay		6.9	12.6	0.1		7.4	11.3	1.9		46.6	66.8	3.8
Queue Delay		0.0	0.0	0.0		0.0	0.0	0.0		0.0	0.0	0.0
Total Delay		6.9	12.6	0.1		7.4	11.3	1.9		46.6	66.8	3.8
LOS		A	B	A		A	B	A		D	E	A
Approach Delay			10.8				9.4				46.9	
Approach LOS			B				A				D	
Queue Length 50th (ft)		17	65	0		59	134	0		23	60	0
Queue Length 95th (ft)		34	94	0		96	175	30		52	93	5
Internal Link Dist (ft)			699				709				470	
Turn Bay Length (ft)		405		160		315		185		150		330
Base Capacity (vph)		440	3079	1000		680	3312	1093		227	1012	529
Starvation Cap Reductn		0	0	0		0	0	0		0	0	0
Spillback Cap Reductn		0	0	0		0	0	0		0	0	0
Storage Cap Reductn		0	0	0		0	0	0		0	0	0
Reduced v/c Ratio		0.17	0.16	0.05		0.35	0.29	0.16		0.14	0.13	0.11

Intersection Summary

Cycle Length: 138
 Actuated Cycle Length: 138
 Offset: 10 (7%), Referenced to phase 2:EBTL and 6:WBTL, Start of Green
 Natural Cycle: 50
 Control Type: Actuated-Coordinated

Timings
1: Chapel Hills Drive & Research Parkway

Total Traffic Conditions
Year 2024 - AM Peak Hour











Lane Group	SBL	SBT	SBR
Lane Configurations	↘	↑↑↑	↗
Traffic Volume (vph)	97	192	54
Future Volume (vph)	97	192	54
Satd. Flow (prot)	1770	5085	1583
Flt Permitted	0.492		
Satd. Flow (perm)	916	5085	1583
Satd. Flow (RTOR)			107
Lane Group Flow (vph)	105	209	59
Turn Type	pm+pt	NA	Perm
Protected Phases	3	8	
Permitted Phases	8		8
Detector Phase	3	8	8
Switch Phase			
Minimum Initial (s)	4.0	4.0	4.0
Minimum Split (s)	9.0	10.5	10.5
Total Split (s)	15.0	46.0	46.0
Total Split (%)	10.9%	33.3%	33.3%
Yellow Time (s)	3.0	4.5	4.5
All-Red Time (s)	2.0	2.0	2.0
Lost Time Adjust (s)	0.0	0.0	0.0
Total Lost Time (s)	5.0	6.5	6.5
Lead/Lag	Lead	Lag	Lag
Lead-Lag Optimize?	Yes	Yes	Yes
Recall Mode	None	None	None
Act Effct Green (s)	24.5	17.0	17.0
Actuated g/C Ratio	0.18	0.12	0.12
v/c Ratio	0.47	0.33	0.20
Control Delay	54.8	58.0	2.0
Queue Delay	0.0	0.0	0.0
Total Delay	54.8	58.0	2.0
LOS	D	E	A
Approach Delay		48.3	
Approach LOS		D	
Queue Length 50th (ft)	81	65	0
Queue Length 95th (ft)	135	94	4
Internal Link Dist (ft)		998	
Turn Bay Length (ft)	195		185
Base Capacity (vph)	224	1455	529
Starvation Cap Reductn	0	0	0
Spillback Cap Reductn	0	0	0
Storage Cap Reductn	0	0	0
Reduced v/c Ratio	0.47	0.14	0.11
Intersection Summary			

Timings
 1: Chapel Hills Drive & Research Parkway

Total Traffic Conditions
 Year 2024 - AM Peak Hour

Maximum v/c Ratio: 0.48	
Intersection Signal Delay: 18.6	Intersection LOS: B
Intersection Capacity Utilization 48.8%	ICU Level of Service A
Analysis Period (min) 15	

Splits and Phases: 1: Chapel Hills Drive & Research Parkway

 Ø1	 Ø2 (R)	 Ø3	 Ø4
14 s	63 s	15 s	46 s
 Ø5	 Ø6 (R)	 Ø7	 Ø8
14 s	63 s	15 s	46 s

HCM 6th TWSC
2: Chapel Hills Drive & Highland Ridge Heights/Dynamic Drive

Total Traffic Conditions
Year 2024 - AM Peak Hour

Intersection													
Int Delay, s/veh	3.3												
Movement	EBL	EBT	EBR	WBL	WBT	WBR	NBL	NBT	NBR	SBU	SBL	SBT	SBR
Lane Configurations		↕			↕		↕	↑↑↑	↕		↕	↑↑↑	↕
Traffic Vol, veh/h	1	3	12	41	7	92	34	258	19	5	57	295	6
Future Vol, veh/h	1	3	12	41	7	92	34	258	19	5	57	295	6
Conflicting Peds, #/hr	0	0	0	0	0	0	0	0	0	0	0	0	0
Sign Control	Stop	Stop	Stop	Stop	Stop	Stop	Free	Free	Free	Free	Free	Free	Free
RT Channelized	-	-	None	-	-	None	-	-	None	-	-	-	None
Storage Length	-	-	-	-	-	-	240	-	150	-	230	-	175
Veh in Median Storage, #	-	0	-	-	0	-	-	0	-	-	-	0	-
Grade, %	-	0	-	-	0	-	-	0	-	-	-	0	-
Peak Hour Factor	92	92	92	92	92	92	92	92	92	92	92	92	92
Heavy Vehicles, %	2	2	2	2	2	2	2	2	2	2	2	2	2
Mvmt Flow	1	3	13	45	8	100	37	280	21	5	62	321	7

Major/Minor	Minor2		Minor1		Major1		Major2						
Conflicting Flow All	645	830	161	618	816	140	328	0	0	205	301	0	0
Stage 1	455	455	-	354	354	-	-	-	-	-	-	-	-
Stage 2	190	375	-	264	462	-	-	-	-	-	-	-	-
Critical Hdwy	6.44	6.54	7.14	6.44	6.54	7.14	5.34	-	-	5.64	5.34	-	-
Critical Hdwy Stg 1	7.34	5.54	-	7.34	5.54	-	-	-	-	-	-	-	-
Critical Hdwy Stg 2	6.74	5.54	-	6.74	5.54	-	-	-	-	-	-	-	-
Follow-up Hdwy	3.82	4.02	3.92	3.82	4.02	3.92	3.12	-	-	2.32	3.12	-	-
Pot Cap-1 Maneuver	*501	368	728	519	375	*874	815	-	-	*1478	994	-	-
Stage 1	*470	567	-	713	734	-	-	-	-	-	-	-	-
Stage 2	*897	718	-	659	563	-	-	-	-	-	-	-	-
Platoon blocked, %	1	1		1	1	1		-	-	1	1	-	-
Mov Cap-1 Maneuver	*400	328	728	464	334	*874	815	-	-	*1014	1014	-	-
Mov Cap-2 Maneuver	*400	328	-	464	334	-	-	-	-	-	-	-	-
Stage 1	*449	530	-	681	701	-	-	-	-	-	-	-	-
Stage 2	*750	686	-	601	526	-	-	-	-	-	-	-	-

Approach	EB	WB	NB	SB
HCM Control Delay, s	11.5	12.2	1.1	1.5
HCM LOS	B	B		

Minor Lane/Major Mvmt	NBL	NBT	NBR	EBLn1	WBLn1	SBL	SBT	SBR
Capacity (veh/h)	815	-	-	569	652	1014	-	-
HCM Lane V/C Ratio	0.045	-	-	0.031	0.233	0.066	-	-
HCM Control Delay (s)	9.6	-	-	11.5	12.2	8.8	-	-
HCM Lane LOS	A	-	-	B	B	A	-	-
HCM 95th %tile Q(veh)	0.1	-	-	0.1	0.9	0.2	-	-

Notes
 ~: Volume exceeds capacity \$: Delay exceeds 300s +: Computation Not Defined *: All major volume in platoon

HCM 6th TWSC
3: Access A & Dynamic Drive

Total Traffic Conditions
Year 2024 - AM Peak Hour

Intersection												
Int Delay, s/veh	2.6											
Movement	EBL	EBT	EBR	WBL	WBT	WBR	NBL	NBT	NBR	SBL	SBT	SBR
Lane Configurations	↕			↕			↕			↕		
Traffic Vol, veh/h	4	34	25	10	107	0	38	4	5	0	2	0
Future Vol, veh/h	4	34	25	10	107	0	38	4	5	0	2	0
Conflicting Peds, #/hr	0	0	0	0	0	0	0	0	0	0	0	0
Sign Control	Free	Free	Free	Free	Free	Free	Stop	Stop	Stop	Stop	Stop	Stop
RT Channelized	-	-	None	-	-	None	-	-	None	-	-	None
Storage Length	-	-	-	-	-	-	-	-	-	-	-	-
Veh in Median Storage, #	-	0	-	-	0	-	-	0	-	-	0	-
Grade, %	-	0	-	-	0	-	-	0	-	-	0	-
Peak Hour Factor	92	92	92	92	92	92	92	92	92	92	92	92
Heavy Vehicles, %	2	2	2	2	2	2	2	2	2	2	2	2
Mvmt Flow	4	37	27	11	116	0	41	4	5	0	2	0

Major/Minor	Major1			Major2			Minor1			Minor2		
Conflicting Flow All	116	0	0	64	0	0	198	197	51	201	210	116
Stage 1	-	-	-	-	-	-	59	59	-	138	138	-
Stage 2	-	-	-	-	-	-	139	138	-	63	72	-
Critical Hdwy	4.12	-	-	4.12	-	-	7.12	6.52	6.22	7.12	6.52	6.22
Critical Hdwy Stg 1	-	-	-	-	-	-	6.12	5.52	-	6.12	5.52	-
Critical Hdwy Stg 2	-	-	-	-	-	-	6.12	5.52	-	6.12	5.52	-
Follow-up Hdwy	2.218	-	-	2.218	-	-	3.518	4.018	3.318	3.518	4.018	3.318
Pot Cap-1 Maneuver	1473	-	-	1538	-	-	761	699	1017	757	687	936
Stage 1	-	-	-	-	-	-	953	846	-	865	782	-
Stage 2	-	-	-	-	-	-	864	782	-	948	835	-
Platoon blocked, %	-	-	-	-	-	-	-	-	-	-	-	-
Mov Cap-1 Maneuver	1473	-	-	1538	-	-	753	691	1017	743	679	936
Mov Cap-2 Maneuver	-	-	-	-	-	-	753	691	-	743	679	-
Stage 1	-	-	-	-	-	-	950	843	-	862	776	-
Stage 2	-	-	-	-	-	-	855	776	-	935	832	-

Approach	EB			WB			NB			SB		
HCM Control Delay, s	0.5			0.6			10			10.3		
HCM LOS							B			B		

Minor Lane/Major Mvmt	NBLn1	EBL	EBT	EBR	WBL	WBT	WBR	SBLn1
Capacity (veh/h)	768	1473	-	-	1538	-	-	679
HCM Lane V/C Ratio	0.067	0.003	-	-	0.007	-	-	0.003
HCM Control Delay (s)	10	7.5	0	-	7.4	0	-	10.3
HCM Lane LOS	B	A	A	-	A	A	-	B
HCM 95th %tile Q(veh)	0.2	0	-	-	0	-	-	0

HCM 6th TWSC
4: Research Parkway & Access B

Total Traffic Conditions
Year 2024 - AM Peak Hour

Intersection												
Int Delay, s/veh	1											
Movement	EBL	EBT	EBR	WBL	WBT	WBR	NBL	NBT	NBR	SBL	SBT	SBR
Lane Configurations	↘	↑↑↑	↗	↘	↑↑↑	↗			↗			↗
Traffic Vol, veh/h	35	558	17	39	1221	47	0	0	11	0	0	44
Future Vol, veh/h	35	558	17	39	1221	47	0	0	11	0	0	44
Conflicting Peds, #/hr	0	0	0	0	0	0	0	0	0	0	0	0
Sign Control	Free	Free	Free	Free	Free	Free	Stop	Stop	Stop	Stop	Stop	Stop
RT Channelized	-	-	None	-	-	None	-	-	None	-	-	None
Storage Length	115	-	-	210	-	240	-	-	0	-	-	0
Veh in Median Storage, #	-	0	-	-	0	-	-	0	-	-	0	-
Grade, %	-	0	-	-	0	-	-	0	-	-	0	-
Peak Hour Factor	92	92	92	92	92	92	92	92	92	92	92	92
Heavy Vehicles, %	2	2	2	2	2	2	2	2	2	2	2	2
Mvmt Flow	38	607	18	42	1327	51	0	0	12	0	0	48

Major/Minor	Major1		Major2		Minor1			Minor2				
Conflicting Flow All	1378	0	0	625	0	0	-	-	304	-	-	664
Stage 1	-	-	-	-	-	-	-	-	-	-	-	-
Stage 2	-	-	-	-	-	-	-	-	-	-	-	-
Critical Hdwy	5.34	-	-	5.34	-	-	-	-	7.14	-	-	7.14
Critical Hdwy Stg 1	-	-	-	-	-	-	-	-	-	-	-	-
Critical Hdwy Stg 2	-	-	-	-	-	-	-	-	-	-	-	-
Follow-up Hdwy	3.12	-	-	3.12	-	-	-	-	3.92	-	-	3.92
Pot Cap-1 Maneuver	256	-	-	945	-	-	0	0	*801	0	0	346
Stage 1	-	-	-	-	-	-	0	0	-	0	0	-
Stage 2	-	-	-	-	-	-	0	0	-	0	0	-
Platoon blocked, %		-	-	1	-	-			1			
Mov Cap-1 Maneuver	256	-	-	945	-	-	-	-	*801	-	-	346
Mov Cap-2 Maneuver	-	-	-	-	-	-	-	-	-	-	-	-
Stage 1	-	-	-	-	-	-	-	-	-	-	-	-
Stage 2	-	-	-	-	-	-	-	-	-	-	-	-

Approach	EB		WB		NB			SB		
HCM Control Delay, s	1.2		0.3		9.6			17.1		
HCM LOS					A			C		

Minor Lane/Major Mvmt	NBLn1	EBL	EBT	EBR	WBL	WBT	WBR	SBLn1
Capacity (veh/h)	801	256	-	-	945	-	-	346
HCM Lane V/C Ratio	0.015	0.149	-	-	0.045	-	-	0.138
HCM Control Delay (s)	9.6	21.5	-	-	9	-	-	17.1
HCM Lane LOS	A	C	-	-	A	-	-	C
HCM 95th %tile Q(veh)	0	0.5	-	-	0.1	-	-	0.5

Notes
 ~: Volume exceeds capacity \$: Delay exceeds 300s +: Computation Not Defined *: All major volume in platoon

Timings
1: Chapel Hills Drive & Research Parkway

Total Traffic Conditions
Year 2024 - PM Peak Hour

Lane Group	EBU	EBL	EBT	EBR	WBU	WBL	WBT	WBR	NBU	NBL	NBT	NBR
Lane Configurations												
Traffic Volume (vph)	19	120	1003	39	32	191	496	60	6	41	196	180
Future Volume (vph)	19	120	1003	39	32	191	496	60	6	41	196	180
Satd. Flow (prot)	0	1770	5085	1583	0	1770	5085	1583	0	1770	3539	1583
Flt Permitted		0.441				0.196				0.581		
Satd. Flow (perm)	0	821	5085	1583	0	365	5085	1583	0	1082	3539	1583
Satd. Flow (RTOR)				107				107				179
Lane Group Flow (vph)	0	151	1090	42	0	243	539	65	0	52	213	196
Turn Type	custom	pm+pt	NA	Perm	custom	pm+pt	NA	Perm	custom	pm+pt	NA	Perm
Protected Phases		5	2			1	6			7	4	
Permitted Phases	5	2		2	1	6		6	7	4		4
Detector Phase	5	5	2	2	1	1	6	6	7	7	4	4
Switch Phase												
Minimum Initial (s)	4.0	4.0	4.0	4.0	4.0	4.0	4.0	4.0	4.0	4.0	4.0	4.0
Minimum Split (s)	9.0	9.0	10.5	10.5	9.0	9.0	10.5	10.5	9.0	9.0	10.5	10.5
Total Split (s)	14.0	14.0	63.0	63.0	14.0	14.0	63.0	63.0	15.0	15.0	46.0	46.0
Total Split (%)	10.1%	10.1%	45.7%	45.7%	10.1%	10.1%	45.7%	45.7%	10.9%	10.9%	33.3%	33.3%
Yellow Time (s)	3.0	3.0	4.5	4.5	3.0	3.0	4.5	4.5	3.0	3.0	4.5	4.5
All-Red Time (s)	2.0	2.0	2.0	2.0	2.0	2.0	2.0	2.0	2.0	2.0	2.0	2.0
Lost Time Adjust (s)		0.0	0.0	0.0		0.0	0.0	0.0		0.0	0.0	0.0
Total Lost Time (s)		5.0	6.5	6.5		5.0	6.5	6.5		5.0	6.5	6.5
Lead/Lag	Lead	Lead	Lag	Lag	Lead	Lead	Lag	Lag	Lead	Lead	Lag	Lag
Lead-Lag Optimize?	Yes	Yes	Yes	Yes	Yes	Yes	Yes	Yes	Yes	Yes	Yes	Yes
Recall Mode	None	None	C-Max	C-Max	None	None	C-Max	C-Max	None	None	None	None
Act Effct Green (s)		85.5	74.6	74.6		97.9	82.0	82.0		23.6	13.7	13.7
Actuated g/C Ratio		0.62	0.54	0.54		0.71	0.59	0.59		0.17	0.10	0.10
v/c Ratio		0.26	0.40	0.05		0.57	0.18	0.07		0.23	0.61	0.62
Control Delay		8.7	19.7	0.1		12.5	13.4	0.6		45.1	66.8	19.2
Queue Delay		0.0	0.0	0.0		0.0	0.0	0.0		0.0	0.0	0.0
Total Delay		8.7	19.7	0.1		12.5	13.4	0.6		45.1	66.8	19.2
LOS		A	B	A		B	B	A		D	E	B
Approach Delay			17.7				12.2					44.1
Approach LOS			B				B					D
Queue Length 50th (ft)		39	201	0		67	76	0		38	97	14
Queue Length 95th (ft)		69	267	0		110	109	5		74	138	92
Internal Link Dist (ft)			699				709				470	
Turn Bay Length (ft)		405		160		315		185		150		330
Base Capacity (vph)		579	2749	905		429	3022	984		247	1012	580
Starvation Cap Reductn		0	0	0		0	0	0		0	0	0
Spillback Cap Reductn		0	0	0		0	0	0		0	0	0
Storage Cap Reductn		0	0	0		0	0	0		0	0	0
Reduced v/c Ratio		0.26	0.40	0.05		0.57	0.18	0.07		0.21	0.21	0.34

Intersection Summary

Cycle Length: 138
 Actuated Cycle Length: 138
 Offset: 10 (7%), Referenced to phase 2:EBTL and 6:WBTL, Start of Green
 Natural Cycle: 60
 Control Type: Actuated-Coordinated

Timings
1: Chapel Hills Drive & Research Parkway

Total Traffic Conditions
Year 2024 - PM Peak Hour



Lane Group	SBL	SBT	SBR
Lane Configurations	↘	↑↑↑	↗
Traffic Volume (vph)	132	245	47
Future Volume (vph)	132	245	47
Satd. Flow (prot)	1770	5085	1583
Flt Permitted	0.459		
Satd. Flow (perm)	855	5085	1583
Satd. Flow (RTOR)			107
Lane Group Flow (vph)	143	266	51
Turn Type	pm+pt	NA	Perm
Protected Phases	3	8	
Permitted Phases	8		8
Detector Phase	3	8	8
Switch Phase			
Minimum Initial (s)	4.0	4.0	4.0
Minimum Split (s)	9.0	10.5	10.5
Total Split (s)	15.0	46.0	46.0
Total Split (%)	10.9%	33.3%	33.3%
Yellow Time (s)	3.0	4.5	4.5
All-Red Time (s)	2.0	2.0	2.0
Lost Time Adjust (s)	0.0	0.0	0.0
Total Lost Time (s)	5.0	6.5	6.5
Lead/Lag	Lead	Lag	Lag
Lead-Lag Optimize?	Yes	Yes	Yes
Recall Mode	None	None	None
Act Effct Green (s)	26.9	17.4	17.4
Actuated g/C Ratio	0.19	0.13	0.13
v/c Ratio	0.62	0.41	0.17
Control Delay	58.2	58.4	1.3
Queue Delay	0.0	0.0	0.0
Total Delay	58.2	58.4	1.3
LOS	E	E	A
Approach Delay		52.0	
Approach LOS		D	
Queue Length 50th (ft)	110	83	0
Queue Length 95th (ft)	170	113	0
Internal Link Dist (ft)		998	
Turn Bay Length (ft)	195		185
Base Capacity (vph)	233	1455	529
Starvation Cap Reductn	0	0	0
Spillback Cap Reductn	0	0	0
Storage Cap Reductn	0	0	0
Reduced v/c Ratio	0.61	0.18	0.10









Intersection Summary

Timings
 1: Chapel Hills Drive & Research Parkway

Total Traffic Conditions
 Year 2024 - PM Peak Hour

Maximum v/c Ratio: 0.62	Intersection LOS: C
Intersection Signal Delay: 25.3	ICU Level of Service C
Intersection Capacity Utilization 69.4%	
Analysis Period (min) 15	

Splits and Phases: 1: Chapel Hills Drive & Research Parkway

 Ø1	 Ø2 (R)	 Ø3	 Ø4
14 s	63 s	15 s	46 s
 Ø5	 Ø6 (R)	 Ø7	 Ø8
14 s	63 s	15 s	46 s

HCM 6th TWSC
 2: Chapel Hills Drive & Highland Ridge Heights/Dynamic Drive

Total Traffic Conditions
 Year 2024 - PM Peak Hour

Intersection													
Int Delay, s/veh	2.8												
Movement	EBL	EBT	EBR	WBL	WBT	WBR	NBL	NBT	NBR	SBU	SBL	SBT	SBR
Lane Configurations		↕			↕		↙	↑↑↑	↘		↘	↑↑↑	↙
Traffic Vol, veh/h	0	8	52	45	2	51	21	350	27	5	56	298	7
Future Vol, veh/h	0	8	52	45	2	51	21	350	27	5	56	298	7
Conflicting Peds, #/hr	0	0	0	0	0	0	0	0	0	0	0	0	0
Sign Control	Stop	Stop	Stop	Stop	Stop	Stop	Free	Free	Free	Free	Free	Free	Free
RT Channelized	-	-	None	-	-	None	-	-	None	-	-	-	None
Storage Length	-	-	-	-	-	-	240	-	150	-	230	-	175
Veh in Median Storage, #	-	0	-	-	0	-	-	0	-	-	-	0	-
Grade, %	-	0	-	-	0	-	-	0	-	-	-	0	-
Peak Hour Factor	92	92	92	92	92	92	92	92	92	92	92	92	92
Heavy Vehicles, %	2	2	2	2	2	2	2	2	2	2	2	2	2
Mvmt Flow	0	9	57	49	2	55	23	380	29	5	61	324	8

Major/Minor	Minor2		Minor1		Major1			Major2					
Conflicting Flow All	655	911	162	692	890	190	332	0	0	278	409	0	0
Stage 1	456	456	-	426	426	-	-	-	-	-	-	-	-
Stage 2	199	455	-	266	464	-	-	-	-	-	-	-	-
Critical Hdwy	6.44	6.54	7.14	6.44	6.54	7.14	5.34	-	-	5.64	5.34	-	-
Critical Hdwy Stg 1	7.34	5.54	-	7.34	5.54	-	-	-	-	-	-	-	-
Critical Hdwy Stg 2	6.74	5.54	-	6.74	5.54	-	-	-	-	-	-	-	-
Follow-up Hdwy	3.82	4.02	3.92	3.82	4.02	3.92	3.12	-	-	2.32	3.12	-	-
Pot Cap-1 Maneuver	*598	394	726	568	406	*837	811	-	-	*1414	1035	-	-
Stage 1	*469	567	-	816	789	-	-	-	-	-	-	-	-
Stage 2	*859	765	-	657	562	-	-	-	-	-	-	-	-
Platoon blocked, %	1	1		1	1	1		-	-	1	1	-	-
Mov Cap-1 Maneuver	*518	359	726	479	370	*837	811	-	-	*1054	1054	-	-
Mov Cap-2 Maneuver	*518	359	-	479	370	-	-	-	-	-	-	-	-
Stage 1	*456	531	-	793	767	-	-	-	-	-	-	-	-
Stage 2	*777	743	-	559	527	-	-	-	-	-	-	-	-

Approach	EB		WB		NB		SB	
HCM Control Delay, s	11.3		12.1		0.5		1.4	
HCM LOS	B		B					

Minor Lane/Major Mvmt	NBL	NBT	NBR	EBLn1	WBLn1	SBL	SBT	SBR
Capacity (veh/h)	811	-	-	639	611	1054	-	-
HCM Lane V/C Ratio	0.028	-	-	0.102	0.174	0.063	-	-
HCM Control Delay (s)	9.6	-	-	11.3	12.1	8.6	-	-
HCM Lane LOS	A	-	-	B	B	A	-	-
HCM 95th %tile Q(veh)	0.1	-	-	0.3	0.6	0.2	-	-

Notes
 ~: Volume exceeds capacity \$: Delay exceeds 300s +: Computation Not Defined *: All major volume in platoon

HCM 6th TWSC
3: Access A & Dynamic Drive

Total Traffic Conditions
Year 2024 - PM Peak Hour

Intersection												
Int Delay, s/veh	2.8											
Movement	EBL	EBT	EBR	WBL	WBT	WBR	NBL	NBT	NBR	SBL	SBT	SBR
Lane Configurations	↕			↕			↕			↕		
Traffic Vol, veh/h	0	82	30	6	42	1	26	4	14	3	5	7
Future Vol, veh/h	0	82	30	6	42	1	26	4	14	3	5	7
Conflicting Peds, #/hr	0	0	0	0	0	0	0	0	0	0	0	0
Sign Control	Free	Free	Free	Free	Free	Free	Stop	Stop	Stop	Stop	Stop	Stop
RT Channelized	-	-	None	-	-	None	-	-	None	-	-	None
Storage Length	-	-	-	-	-	-	-	-	-	-	-	-
Veh in Median Storage, #	-	0	-	-	0	-	-	0	-	-	0	-
Grade, %	-	0	-	-	0	-	-	0	-	-	0	-
Peak Hour Factor	92	92	92	92	92	92	92	92	92	92	92	92
Heavy Vehicles, %	2	2	2	2	2	2	2	2	2	2	2	2
Mvmt Flow	0	89	33	7	46	1	28	4	15	3	5	8

Major/Minor	Major1			Major2			Minor1			Minor2		
Conflicting Flow All	47	0	0	122	0	0	173	167	106	176	183	47
Stage 1	-	-	-	-	-	-	106	106	-	61	61	-
Stage 2	-	-	-	-	-	-	67	61	-	115	122	-
Critical Hdwy	4.12	-	-	4.12	-	-	7.12	6.52	6.22	7.12	6.52	6.22
Critical Hdwy Stg 1	-	-	-	-	-	-	6.12	5.52	-	6.12	5.52	-
Critical Hdwy Stg 2	-	-	-	-	-	-	6.12	5.52	-	6.12	5.52	-
Follow-up Hdwy	2.218	-	-	2.218	-	-	3.518	4.018	3.318	3.518	4.018	3.318
Pot Cap-1 Maneuver	1560	-	-	1465	-	-	790	726	948	786	711	1022
Stage 1	-	-	-	-	-	-	900	807	-	950	844	-
Stage 2	-	-	-	-	-	-	943	844	-	890	795	-
Platoon blocked, %	-	-	-	-	-	-	-	-	-	-	-	-
Mov Cap-1 Maneuver	1560	-	-	1465	-	-	777	722	948	767	707	1022
Mov Cap-2 Maneuver	-	-	-	-	-	-	777	722	-	767	707	-
Stage 1	-	-	-	-	-	-	900	807	-	950	840	-
Stage 2	-	-	-	-	-	-	925	840	-	871	795	-

Approach	EB			WB			NB			SB		
HCM Control Delay, s	0			0.9			9.7			9.4		
HCM LOS							A			A		

Minor Lane/Major Mvmt	NBLn1	EBL	EBT	EBR	WBL	WBT	WBR	SBLn1
Capacity (veh/h)	818	1560	-	-	1465	-	-	841
HCM Lane V/C Ratio	0.058	-	-	-	0.004	-	-	0.019
HCM Control Delay (s)	9.7	0	-	-	7.5	0	-	9.4
HCM Lane LOS	A	A	-	-	A	A	-	A
HCM 95th %tile Q(veh)	0.2	0	-	-	0	-	-	0.1

HCM 6th TWSC
4: Research Parkway & Access B

Total Traffic Conditions
Year 2024 - PM Peak Hour

Intersection												
Int Delay, s/veh	0.7											
Movement	EBL	EBT	EBR	WBL	WBT	WBR	NBL	NBT	NBR	SBL	SBT	SBR
Lane Configurations	↘	↑↑↑	↗	↘	↑↑↑	↗			↗			↗
Traffic Vol, veh/h	36	1299	5	6	694	31	0	0	55	0	0	35
Future Vol, veh/h	36	1299	5	6	694	31	0	0	55	0	0	35
Conflicting Peds, #/hr	0	0	0	0	0	0	0	0	0	0	0	0
Sign Control	Free	Free	Free	Free	Free	Free	Stop	Stop	Stop	Stop	Stop	Stop
RT Channelized	-	-	None	-	-	None	-	-	None	-	-	None
Storage Length	115	-	-	210	-	240	-	-	0	-	-	0
Veh in Median Storage, #	-	0	-	-	0	-	-	0	-	-	0	-
Grade, %	-	0	-	-	0	-	-	0	-	-	0	-
Peak Hour Factor	92	92	92	92	92	92	92	92	92	92	92	92
Heavy Vehicles, %	2	2	2	2	2	2	2	2	2	2	2	2
Mvmt Flow	39	1412	5	7	754	34	0	0	60	0	0	38

Major/Minor	Major1		Major2		Minor1		Minor2					
Conflicting Flow All	788	0	0	1417	0	0	-	-	706	-	-	377
Stage 1	-	-	-	-	-	-	-	-	-	-	-	-
Stage 2	-	-	-	-	-	-	-	-	-	-	-	-
Critical Hdwy	5.34	-	-	5.34	-	-	-	-	7.14	-	-	7.14
Critical Hdwy Stg 1	-	-	-	-	-	-	-	-	-	-	-	-
Critical Hdwy Stg 2	-	-	-	-	-	-	-	-	-	-	-	-
Follow-up Hdwy	3.12	-	-	3.12	-	-	-	-	3.92	-	-	3.92
Pot Cap-1 Maneuver	495	-	-	*770	-	-	0	0	*613	0	0	530
Stage 1	-	-	-	-	-	-	0	0	-	0	0	-
Stage 2	-	-	-	-	-	-	0	0	-	0	0	-
Platoon blocked, %		-	-	1	-	-			1			
Mov Cap-1 Maneuver	495	-	-	*770	-	-	-	-	*613	-	-	530
Mov Cap-2 Maneuver	-	-	-	-	-	-	-	-	-	-	-	-
Stage 1	-	-	-	-	-	-	-	-	-	-	-	-
Stage 2	-	-	-	-	-	-	-	-	-	-	-	-





















Approach	EB		WB		NB		SB	
HCM Control Delay, s	0.3		0.1		11.5		12.3	
HCM LOS					B		B	

Minor Lane/Major Mvmt	NBLn1	EBL	EBT	EBR	WBL	WBT	WBR	SBLn1
Capacity (veh/h)	613	495	-	-	* 770	-	-	530
HCM Lane V/C Ratio	0.098	0.079	-	-	0.008	-	-	0.072
HCM Control Delay (s)	11.5	12.9	-	-	9.7	-	-	12.3
HCM Lane LOS	B	B	-	-	A	-	-	B
HCM 95th %tile Q(veh)	0.3	0.3	-	-	0	-	-	0.2

Notes
 ~: Volume exceeds capacity \$: Delay exceeds 300s +: Computation Not Defined *: All major volume in platoon

Timings
1: Chapel Hills Drive & Research Parkway

Total Traffic Conditions
Year 2042 - AM Peak Hour

												
Lane Group	EBU	EBL	EBT	EBR	WBU	WBL	WBT	WBR	NBU	NBL	NBT	NBR
Lane Configurations												
Traffic Volume (vph)	2	116	746	81	26	333	1500	280	7	43	202	91
Future Volume (vph)	2	116	746	81	26	333	1500	280	7	43	202	91
Satd. Flow (prot)	0	1770	5085	1583	0	1770	5085	1583	0	1770	3539	1583
Flt Permitted		0.112				0.274				0.533		
Satd. Flow (perm)	0	209	5085	1583	0	510	5085	1583	0	993	3539	1583
Satd. Flow (RTOR)				186				222				186
Lane Group Flow (vph)	0	128	811	88	0	390	1630	304	0	55	220	99
Turn Type	custom	pm+pt	NA	Perm	custom	pm+pt	NA	Perm	custom	pm+pt	NA	Perm
Protected Phases		5	2			1	6			7	4	
Permitted Phases	5	2		2	1	6		6	7	4		4
Detector Phase	5	5	2	2	1	1	6	6	7	7	4	4
Switch Phase												
Minimum Initial (s)	4.0	4.0	4.0	4.0	4.0	4.0	4.0	4.0	4.0	4.0	4.0	4.0
Minimum Split (s)	9.0	9.0	10.5	10.5	9.0	9.0	10.5	10.5	9.0	9.0	10.5	10.5
Total Split (s)	19.0	19.0	52.0	52.0	42.0	42.0	75.0	75.0	11.0	11.0	24.0	24.0
Total Split (%)	13.8%	13.8%	37.7%	37.7%	30.4%	30.4%	54.3%	54.3%	8.0%	8.0%	17.4%	17.4%
Yellow Time (s)	3.0	3.0	4.5	4.5	3.0	3.0	4.5	4.5	3.0	3.0	4.5	4.5
All-Red Time (s)	2.0	2.0	2.0	2.0	2.0	2.0	2.0	2.0	2.0	2.0	2.0	2.0
Lost Time Adjust (s)		0.0	0.0	0.0		0.0	0.0	0.0		0.0	0.0	0.0
Total Lost Time (s)		5.0	6.5	6.5		5.0	6.5	6.5		5.0	6.5	6.5
Lead/Lag	Lead	Lead	Lag	Lag	Lead	Lead	Lag	Lag	Lead	Lead	Lag	Lag
Lead-Lag Optimize?	Yes	Yes	Yes	Yes	Yes	Yes	Yes	Yes	Yes	Yes	Yes	Yes
Recall Mode	None	None	C-Max	C-Max	None	None	C-Max	C-Max	None	None	None	None
Act Effct Green (s)		77.9	66.9	66.9		93.5	77.5	77.5		21.3	13.9	13.9
Actuated g/C Ratio		0.56	0.48	0.48		0.68	0.56	0.56		0.15	0.10	0.10
v/c Ratio		0.57	0.33	0.10		0.74	0.57	0.31		0.30	0.62	0.30
Control Delay		26.1	23.9	0.2		18.9	21.3	5.8		43.7	67.1	2.4
Queue Delay		0.0	0.0	0.0		0.0	0.0	0.0		0.0	0.0	0.0
Total Delay		26.1	23.9	0.2		18.9	21.3	5.8		43.7	67.1	2.4
LOS		C	C	A		B	C	A		D	E	A
Approach Delay			22.1				18.9					46.5
Approach LOS			C				B					D
Queue Length 50th (ft)		38	159	0		137	335	33		38	101	0
Queue Length 95th (ft)		95	237	0		208	438	96		72	142	0
Internal Link Dist (ft)			699				709					470
Turn Bay Length (ft)		405		160		315		185		150		330
Base Capacity (vph)		282	2465	863		683	2856	986		187	448	363
Starvation Cap Reductn		0	0	0		0	0	0		0	0	0
Spillback Cap Reductn		0	0	0		0	0	0		0	0	0
Storage Cap Reductn		0	0	0		0	0	0		0	0	0
Reduced v/c Ratio		0.45	0.33	0.10		0.57	0.57	0.31		0.29	0.49	0.27

Intersection Summary

Cycle Length: 138
 Actuated Cycle Length: 138
 Offset: 10 (7%), Referenced to phase 2:EBTL and 6:WBTL, Start of Green
 Natural Cycle: 60
 Control Type: Actuated-Coordinated

Timings
1: Chapel Hills Drive & Research Parkway

Total Traffic Conditions
Year 2042 - AM Peak Hour



Lane Group	SBL	SBT	SBR
Lane Configurations	↘	↑↑↑	↗
Traffic Volume (vph)	159	324	92
Future Volume (vph)	159	324	92
Satd. Flow (prot)	1770	5085	1583
Flt Permitted	0.399		
Satd. Flow (perm)	743	5085	1583
Satd. Flow (RTOR)			146
Lane Group Flow (vph)	173	352	100
Turn Type	pm+pt	NA	Perm
Protected Phases	3	8	
Permitted Phases	8		8
Detector Phase	3	8	8
Switch Phase			
Minimum Initial (s)	4.0	4.0	4.0
Minimum Split (s)	9.0	10.5	10.5
Total Split (s)	20.0	33.0	33.0
Total Split (%)	14.5%	23.9%	23.9%
Yellow Time (s)	3.0	4.5	4.5
All-Red Time (s)	2.0	2.0	2.0
Lost Time Adjust (s)	0.0	0.0	0.0
Total Lost Time (s)	5.0	6.5	6.5
Lead/Lag	Lead	Lag	Lag
Lead-Lag Optimize?	Yes	Yes	Yes
Recall Mode	None	None	None
Act Effct Green (s)	34.5	24.2	24.2
Actuated g/C Ratio	0.25	0.18	0.18
v/c Ratio	0.60	0.40	0.25
Control Delay	51.3	51.9	3.2
Queue Delay	0.0	0.0	0.0
Total Delay	51.3	51.9	3.2
LOS	D	D	A
Approach Delay		43.9	
Approach LOS		D	
Queue Length 50th (ft)	129	105	0
Queue Length 95th (ft)	193	135	15
Internal Link Dist (ft)		998	
Turn Bay Length (ft)	195		185
Base Capacity (vph)	297	976	421
Starvation Cap Reductn	0	0	0
Spillback Cap Reductn	0	0	0
Storage Cap Reductn	0	0	0
Reduced v/c Ratio	0.58	0.36	0.24









Intersection Summary

Timings
 1: Chapel Hills Drive & Research Parkway

Total Traffic Conditions
 Year 2042 - AM Peak Hour

Maximum v/c Ratio: 0.74	Intersection LOS: C
Intersection Signal Delay: 25.6	ICU Level of Service C
Intersection Capacity Utilization 69.1%	
Analysis Period (min) 15	

Splits and Phases: 1: Chapel Hills Drive & Research Parkway

 Ø1	 Ø2 (R)	 Ø3	 Ø4
42 s	52 s	20 s	24 s
 Ø5	 Ø6 (R)	 Ø7	 Ø8
19 s	75 s	11 s	33 s

HCM 6th TWSC
2: Chapel Hills Drive & Highland Ridge Heights/Dynamic Drive

Total Traffic Conditions
Year 2042 - AM Peak Hour

Intersection													
Int Delay, s/veh	4.3												
Movement	EBL	EBT	EBR	WBL	WBT	WBR	NBL	NBT	NBR	SBU	SBL	SBT	SBR
Lane Configurations		↕			↕		↕	↑↑↑	↕		↕	↑↑↑	↕
Traffic Vol, veh/h	2	5	20	61	9	143	58	436	31	9	92	501	11
Future Vol, veh/h	2	5	20	61	9	143	58	436	31	9	92	501	11
Conflicting Peds, #/hr	0	0	0	0	0	0	0	0	0	0	0	0	0
Sign Control	Stop	Stop	Stop	Stop	Stop	Stop	Free	Free	Free	Free	Free	Free	Free
RT Channelized	-	-	None	-	-	None	-	-	None	-	-	-	None
Storage Length	-	-	-	-	-	-	240	-	150	-	230	-	175
Veh in Median Storage, #	-	0	-	-	0	-	-	0	-	-	-	0	-
Grade, %	-	0	-	-	0	-	-	0	-	-	-	0	-
Peak Hour Factor	92	92	92	92	92	92	92	92	92	92	92	92	92
Heavy Vehicles, %	2	2	2	2	2	2	2	2	2	2	2	2	2
Mvmt Flow	2	5	22	66	10	155	63	474	34	10	100	545	12

Major/Minor	Minor2		Minor1		Major1		Major2						
Conflicting Flow All	1086	1399	273	1041	1377	237	557	0	0	346	508	0	0
Stage 1	765	765	-	600	600	-	-	-	-	-	-	-	-
Stage 2	321	634	-	441	777	-	-	-	-	-	-	-	-
Critical Hdwy	6.44	6.54	7.14	6.44	6.54	7.14	5.34	-	-	5.64	5.34	-	-
Critical Hdwy Stg 1	7.34	5.54	-	7.34	5.54	-	-	-	-	-	-	-	-
Critical Hdwy Stg 2	6.74	5.54	-	6.74	5.54	-	-	-	-	-	-	-	-
Follow-up Hdwy	3.82	4.02	3.92	3.82	4.02	3.92	3.12	-	-	2.32	3.12	-	-
Pot Cap-1 Maneuver	*353	209	618	377	216	*818	637	-	-	*1382	1003	-	-
Stage 1	*289	410	-	693	705	-	-	-	-	-	-	-	-
Stage 2	*839	678	-	517	405	-	-	-	-	-	-	-	-
Platoon blocked, %	1	1		1	1	1		-	-	1	1	-	-
Mov Cap-1 Maneuver	*233	168	618	301	174	*818	637	-	-	*1014	1014	-	-
Mov Cap-2 Maneuver	*233	168	-	301	174	-	-	-	-	-	-	-	-
Stage 1	*260	366	-	624	635	-	-	-	-	-	-	-	-
Stage 2	*603	611	-	438	361	-	-	-	-	-	-	-	-

Approach	EB	WB	NB	SB
HCM Control Delay, s	15.2	18.5	1.2	1.5
HCM LOS	C	C		

Minor Lane/Major Mvmt	NBL	NBT	NBR	EBLn1	WBLn1	SBL	SBT	SBR
Capacity (veh/h)	637	-	-	382	496	1014	-	-
HCM Lane V/C Ratio	0.099	-	-	0.077	0.467	0.108	-	-
HCM Control Delay (s)	11.3	-	-	15.2	18.5	9	-	-
HCM Lane LOS	B	-	-	C	C	A	-	-
HCM 95th %tile Q(veh)	0.3	-	-	0.2	2.4	0.4	-	-

Notes
 ~: Volume exceeds capacity \$: Delay exceeds 300s +: Computation Not Defined *: All major volume in platoon

HCM 6th TWSC
3: Access A & Dynamic Drive

Total Traffic Conditions
Year 2042 - AM Peak Hour

Intersection												
Int Delay, s/veh	2.2											
Movement	EBL	EBT	EBR	WBL	WBT	WBR	NBL	NBT	NBR	SBL	SBT	SBR
Lane Configurations	↕			↕			↕			↕		
Traffic Vol, veh/h	7	58	33	16	182	0	40	4	6	0	3	0
Future Vol, veh/h	7	58	33	16	182	0	40	4	6	0	3	0
Conflicting Peds, #/hr	0	0	0	0	0	0	0	0	0	0	0	0
Sign Control	Free	Free	Free	Free	Free	Free	Stop	Stop	Stop	Stop	Stop	Stop
RT Channelized	-	-	None	-	-	None	-	-	None	-	-	None
Storage Length	-	-	-	-	-	-	-	-	-	-	-	-
Veh in Median Storage, #	-	0	-	-	0	-	-	0	-	-	0	-
Grade, %	-	0	-	-	0	-	-	0	-	-	0	-
Peak Hour Factor	92	92	92	92	92	92	92	92	92	92	92	92
Heavy Vehicles, %	2	2	2	2	2	2	2	2	2	2	2	2
Mvmt Flow	8	63	36	17	198	0	43	4	7	0	3	0

Major/Minor	Major1			Major2			Minor1			Minor2		
Conflicting Flow All	198	0	0	99	0	0	331	329	81	335	347	198
Stage 1	-	-	-	-	-	-	97	97	-	232	232	-
Stage 2	-	-	-	-	-	-	234	232	-	103	115	-
Critical Hdwy	4.12	-	-	4.12	-	-	7.12	6.52	6.22	7.12	6.52	6.22
Critical Hdwy Stg 1	-	-	-	-	-	-	6.12	5.52	-	6.12	5.52	-
Critical Hdwy Stg 2	-	-	-	-	-	-	6.12	5.52	-	6.12	5.52	-
Follow-up Hdwy	2.218	-	-	2.218	-	-	3.518	4.018	3.318	3.518	4.018	3.318
Pot Cap-1 Maneuver	1375	-	-	1494	-	-	622	590	979	619	576	843
Stage 1	-	-	-	-	-	-	910	815	-	771	713	-
Stage 2	-	-	-	-	-	-	769	713	-	903	800	-
Platoon blocked, %	-	-	-	-	-	-	-	-	-	-	-	-
Mov Cap-1 Maneuver	1375	-	-	1494	-	-	610	579	979	602	565	843
Mov Cap-2 Maneuver	-	-	-	-	-	-	610	579	-	602	565	-
Stage 1	-	-	-	-	-	-	905	810	-	766	704	-
Stage 2	-	-	-	-	-	-	755	704	-	887	795	-

Approach	EB			WB			NB			SB		
HCM Control Delay, s	0.5			0.6			11.2			11.4		
HCM LOS							B			B		

Minor Lane/Major Mvmt	NBLn1	EBL	EBT	EBR	WBL	WBT	WBR	SBLn1
Capacity (veh/h)	636	1375	-	-	1494	-	-	565
HCM Lane V/C Ratio	0.085	0.006	-	-	0.012	-	-	0.006
HCM Control Delay (s)	11.2	7.6	0	-	7.4	0	-	11.4
HCM Lane LOS	B	A	A	-	A	A	-	B
HCM 95th %tile Q(veh)	0.3	0	-	-	0	-	-	0

HCM 6th TWSC
4: Research Parkway & Access B

Total Traffic Conditions
Year 2042 - AM Peak Hour

Intersection												
Int Delay, s/veh	2.6											
Movement	EBL	EBT	EBR	WBL	WBT	WBR	NBL	NBT	NBR	SBL	SBT	SBR
Lane Configurations	↘	↑↑↑	↗	↘	↑↑↑	↗			↗			↗
Traffic Vol, veh/h	53	936	29	67	2079	76	0	0	18	0	0	50
Future Vol, veh/h	53	936	29	67	2079	76	0	0	18	0	0	50
Conflicting Peds, #/hr	0	0	0	0	0	0	0	0	0	0	0	0
Sign Control	Free	Free	Free	Free	Free	Free	Stop	Stop	Stop	Stop	Stop	Stop
RT Channelized	-	-	None	-	-	None	-	-	None	-	-	None
Storage Length	115	-	-	210	-	240	-	-	0	-	-	0
Veh in Median Storage, #	-	0	-	-	0	-	-	0	-	-	0	-
Grade, %	-	0	-	-	0	-	-	0	-	-	0	-
Peak Hour Factor	92	92	92	92	92	92	92	92	92	92	92	92
Heavy Vehicles, %	2	2	2	2	2	2	2	2	2	2	2	2
Mvmt Flow	58	1017	32	73	2260	83	0	0	20	0	0	54

Major/Minor	Major1			Major2			Minor1			Minor2		
Conflicting Flow All	2343	0	0	1049	0	0	-	-	509	-	-	1130
Stage 1	-	-	-	-	-	-	-	-	-	-	-	-
Stage 2	-	-	-	-	-	-	-	-	-	-	-	-
Critical Hdwy	5.34	-	-	5.34	-	-	-	-	7.14	-	-	7.14
Critical Hdwy Stg 1	-	-	-	-	-	-	-	-	-	-	-	-
Critical Hdwy Stg 2	-	-	-	-	-	-	-	-	-	-	-	-
Follow-up Hdwy	3.12	-	-	3.12	-	-	-	-	3.92	-	-	3.92
Pot Cap-1 Maneuver	83	-	-	870	-	-	0	0	*707	0	0	170
Stage 1	-	-	-	-	-	-	0	0	-	0	0	-
Stage 2	-	-	-	-	-	-	0	0	-	0	0	-
Platoon blocked, %		-	-	1	-	-			1			
Mov Cap-1 Maneuver	83	-	-	870	-	-	-	-	*707	-	-	170
Mov Cap-2 Maneuver	-	-	-	-	-	-	-	-	-	-	-	-
Stage 1	-	-	-	-	-	-	-	-	-	-	-	-
Stage 2	-	-	-	-	-	-	-	-	-	-	-	-

Approach	EB		WB		NB		SB	
HCM Control Delay, s	6		0.3		10.2		35.8	
HCM LOS					B		E	

Minor Lane/Major Mvmt	NBLn1	EBL	EBT	EBR	WBL	WBT	WBR	SBLn1
Capacity (veh/h)	707	83	-	-	870	-	-	170
HCM Lane V/C Ratio	0.028	0.694	-	-	0.084	-	-	0.32
HCM Control Delay (s)	10.2	114.8	-	-	9.5	-	-	35.8
HCM Lane LOS	B	F	-	-	A	-	-	E
HCM 95th %tile Q(veh)	0.1	3.3	-	-	0.3	-	-	1.3

Notes
 ~: Volume exceeds capacity \$: Delay exceeds 300s +: Computation Not Defined *: All major volume in platoon

Timings
1: Chapel Hills Drive & Research Parkway

Total Traffic Conditions
Year 2042 - PM Peak Hour

Lane Group	EBU	EBL	EBT	EBR	WBU	WBL	WBT	WBR	NBU	NBL	NBT	NBR
Lane Configurations												
Traffic Volume (vph)	33	204	1699	67	50	321	840	101	11	70	331	301
Future Volume (vph)	33	204	1699	67	50	321	840	101	11	70	331	301
Satd. Flow (prot)	0	1770	5085	1583	0	1770	5085	1583	0	1770	3539	1583
Flt Permitted		0.300				0.064				0.482		
Satd. Flow (perm)	0	559	5085	1583	0	119	5085	1583	0	898	3539	1583
Satd. Flow (RTOR)				186				146				222
Lane Group Flow (vph)	0	258	1847	73	0	403	913	110	0	88	360	327
Turn Type	custom	pm+pt	NA	Perm	custom	pm+pt	NA	Perm	custom	pm+pt	NA	Perm
Protected Phases		5	2			1	6			7	4	
Permitted Phases	5	2		2	1	6		6	7	4		4
Detector Phase	5	5	2	2	1	1	6	6	7	7	4	4
Switch Phase												
Minimum Initial (s)	4.0	4.0	4.0	4.0	4.0	4.0	4.0	4.0	4.0	4.0	4.0	4.0
Minimum Split (s)	9.0	9.0	10.5	10.5	9.0	9.0	10.5	10.5	9.0	9.0	10.5	10.5
Total Split (s)	23.0	23.0	64.0	64.0	33.0	33.0	74.0	74.0	12.0	12.0	23.0	23.0
Total Split (%)	16.7%	16.7%	46.4%	46.4%	23.9%	23.9%	53.6%	53.6%	8.7%	8.7%	16.7%	16.7%
Yellow Time (s)	3.0	3.0	4.5	4.5	3.0	3.0	4.5	4.5	3.0	3.0	4.5	4.5
All-Red Time (s)	2.0	2.0	2.0	2.0	2.0	2.0	2.0	2.0	2.0	2.0	2.0	2.0
Lost Time Adjust (s)		0.0	0.0	0.0		0.0	0.0	0.0		0.0	0.0	0.0
Total Lost Time (s)		5.0	6.5	6.5		5.0	6.5	6.5		5.0	6.5	6.5
Lead/Lag	Lead	Lead	Lag	Lag	Lead	Lead	Lag	Lag	Lead	Lead	Lag	Lag
Lead-Lag Optimize?	Yes	Yes	Yes	Yes	Yes	Yes	Yes	Yes	Yes	Yes	Yes	Yes
Recall Mode	None	None	C-Max	C-Max	None	None	C-Max	C-Max	None	None	None	None
Act Effct Green (s)		72.6	57.7	57.7		92.3	72.4	72.4		24.7	16.2	16.2
Actuated g/C Ratio		0.53	0.42	0.42		0.67	0.52	0.52		0.18	0.12	0.12
v/c Ratio		0.63	0.87	0.09		0.97	0.34	0.12		0.43	0.87	0.86
Control Delay		18.7	42.2	0.2		79.2	19.8	1.4		48.1	80.5	40.9
Queue Delay		0.0	0.0	0.0		0.0	0.0	0.0		0.0	0.0	0.0
Total Delay		18.7	42.2	0.2		79.2	19.8	1.4		48.1	80.5	40.9
LOS		B	D	A		E	B	A		D	F	D
Approach Delay			38.0				35.2				60.1	
Approach LOS			D				D				E	
Queue Length 50th (ft)		84	549	0		309	169	0		62	168	95
Queue Length 95th (ft)		123	618	0		#523	215	15		109	#250	#258
Internal Link Dist (ft)			699				709				470	
Turn Bay Length (ft)		405		160		315		185		150		330
Base Capacity (vph)		470	2125	770		415	2667	899		204	423	384
Starvation Cap Reductn		0	0	0		0	0	0		0	0	0
Spillback Cap Reductn		0	0	0		0	0	0		0	0	0
Storage Cap Reductn		0	0	0		0	0	0		0	0	0
Reduced v/c Ratio		0.55	0.87	0.09		0.97	0.34	0.12		0.43	0.85	0.85

Intersection Summary

Cycle Length: 138
 Actuated Cycle Length: 138
 Offset: 10 (7%), Referenced to phase 2:EBTL and 6:WBTL, Start of Green
 Natural Cycle: 90
 Control Type: Actuated-Coordinated

Timings
1: Chapel Hills Drive & Research Parkway

Total Traffic Conditions
Year 2042 - PM Peak Hour











Lane Group	SBL	SBT	SBR
Lane Configurations	↘	↑↑↑	↗
Traffic Volume (vph)	219	415	79
Future Volume (vph)	219	415	79
Satd. Flow (prot)	1770	5085	1583
Flt Permitted	0.212		
Satd. Flow (perm)	395	5085	1583
Satd. Flow (RTOR)			146
Lane Group Flow (vph)	238	451	86
Turn Type	pm+pt	NA	Perm
Protected Phases	3	8	
Permitted Phases	8		8
Detector Phase	3	8	8
Switch Phase			
Minimum Initial (s)	4.0	4.0	4.0
Minimum Split (s)	9.0	10.5	10.5
Total Split (s)	18.0	29.0	29.0
Total Split (%)	13.0%	21.0%	21.0%
Yellow Time (s)	3.0	4.5	4.5
All-Red Time (s)	2.0	2.0	2.0
Lost Time Adjust (s)	0.0	0.0	0.0
Total Lost Time (s)	5.0	6.5	6.5
Lead/Lag	Lead	Lag	Lag
Lead-Lag Optimize?	Yes	Yes	Yes
Recall Mode	None	None	None
Act Effct Green (s)	35.7	22.2	22.2
Actuated g/C Ratio	0.26	0.16	0.16
v/c Ratio	1.03	0.55	0.23
Control Delay	111.7	56.1	1.5
Queue Delay	0.0	0.0	0.0
Total Delay	111.7	56.1	1.5
LOS	F	E	A
Approach Delay		67.1	
Approach LOS		E	
Queue Length 50th (ft)	~189	137	0
Queue Length 95th (ft)	#336	177	2
Internal Link Dist (ft)		998	
Turn Bay Length (ft)	195		185
Base Capacity (vph)	231	829	380
Starvation Cap Reductn	0	0	0
Spillback Cap Reductn	0	0	0
Storage Cap Reductn	0	0	0
Reduced v/c Ratio	1.03	0.54	0.23
Intersection Summary			

Timings
 1: Chapel Hills Drive & Research Parkway

Total Traffic Conditions
 Year 2042 - PM Peak Hour

Maximum v/c Ratio: 1.03	
Intersection Signal Delay: 44.9	Intersection LOS: D
Intersection Capacity Utilization 103.3%	ICU Level of Service G
Analysis Period (min) 15	
~ Volume exceeds capacity, queue is theoretically infinite. Queue shown is maximum after two cycles.	
# 95th percentile volume exceeds capacity, queue may be longer. Queue shown is maximum after two cycles.	

Splits and Phases: 1: Chapel Hills Drive & Research Parkway

 Ø1	 Ø2 (R)	 Ø3	 Ø4
33 s	64 s	18 s	23 s
 Ø5	 Ø6 (R)	 Ø7	 Ø8
23 s	74 s	12 s	29 s

HCM 6th TWSC
 2: Chapel Hills Drive & Highland Ridge Heights/Dynamic Drive

Total Traffic Conditions
 Year 2042 - PM Peak Hour

Intersection													
Int Delay, s/veh	3.6												
Movement	EBL	EBT	EBR	WBL	WBT	WBR	NBL	NBT	NBR	SBU	SBL	SBT	SBR
Lane Configurations		↕			↕		↙	↑↑↑	↘		↘	↑↑↑	↙
Traffic Vol, veh/h	0	10	89	70	2	78	36	594	44	9	81	504	13
Future Vol, veh/h	0	10	89	70	2	78	36	594	44	9	81	504	13
Conflicting Peds, #/hr	0	0	0	0	0	0	0	0	0	0	0	0	0
Sign Control	Stop	Stop	Stop	Stop	Stop	Stop	Free	Free	Free	Free	Free	Free	Free
RT Channelized	-	-	None	-	-	None	-	-	None	-	-	-	None
Storage Length	-	-	-	-	-	-	240	-	150	-	230	-	175
Veh in Median Storage, #	-	0	-	-	0	-	-	0	-	-	-	0	-
Grade, %	-	0	-	-	0	-	-	0	-	-	-	0	-
Peak Hour Factor	92	92	92	92	92	92	92	92	92	92	92	92	92
Heavy Vehicles, %	2	2	2	2	2	2	2	2	2	2	2	2	2
Mvmt Flow	0	11	97	76	2	85	39	646	48	10	88	548	14

Major/Minor	Minor2		Minor1		Major1		Major2						
Conflicting Flow All	1081	1516	274	1145	1482	323	562	0	0	471	694	0	0
Stage 1	744	744	-	724	724	-	-	-	-	-	-	-	-
Stage 2	337	772	-	421	758	-	-	-	-	-	-	-	-
Critical Hdwy	6.44	6.54	7.14	6.44	6.54	7.14	5.34	-	-	5.64	5.34	-	-
Critical Hdwy Stg 1	7.34	5.54	-	7.34	5.54	-	-	-	-	-	-	-	-
Critical Hdwy Stg 2	6.74	5.54	-	6.74	5.54	-	-	-	-	-	-	-	-
Follow-up Hdwy	3.82	4.02	3.92	3.82	4.02	3.92	3.12	-	-	2.32	3.12	-	-
Pot Cap-1 Maneuver	*433	208	617	392	219	*780	633	-	-	*1319	955	-	-
Stage 1	*299	420	-	731	717	-	-	-	-	-	-	-	-
Stage 2	*801	678	-	531	413	-	-	-	-	-	-	-	-
Platoon blocked, %	1	1		1	1	1		-	-	1	1	-	-
Mov Cap-1 Maneuver	*337	175	617	278	185	*780	633	-	-	*974	974	-	-
Mov Cap-2 Maneuver	*337	175	-	278	185	-	-	-	-	-	-	-	-
Stage 1	*280	378	-	685	673	-	-	-	-	-	-	-	-
Stage 2	*667	636	-	391	371	-	-	-	-	-	-	-	-

Approach	EB		WB		NB		SB	
HCM Control Delay, s	14.4		19.2		0.6		1.4	
HCM LOS	B		C					

Minor Lane/Major Mvmt	NBL	NBT	NBR	EBLn1	WBLn1	SBL	SBT	SBR
Capacity (veh/h)	633	-	-	492	414	974	-	-
HCM Lane V/C Ratio	0.062	-	-	0.219	0.394	0.1	-	-
HCM Control Delay (s)	11.1	-	-	14.4	19.2	9.1	-	-
HCM Lane LOS	B	-	-	B	C	A	-	-
HCM 95th %tile Q(veh)	0.2	-	-	0.8	1.8	0.3	-	-

Notes
 ~: Volume exceeds capacity \$: Delay exceeds 300s +: Computation Not Defined *: All major volume in platoon

HCM 6th TWSC
3: Access A & Dynamic Drive

Total Traffic Conditions
Year 2042 - PM Peak Hour

Intersection												
Int Delay, s/veh	2.6											
Movement	EBL	EBT	EBR	WBL	WBT	WBR	NBL	NBT	NBR	SBL	SBT	SBR
Lane Configurations	↕			↕			↕			↕		
Traffic Vol, veh/h	0	139	31	9	72	2	28	5	22	5	6	13
Future Vol, veh/h	0	139	31	9	72	2	28	5	22	5	6	13
Conflicting Peds, #/hr	0	0	0	0	0	0	0	0	0	0	0	0
Sign Control	Free	Free	Free	Free	Free	Free	Stop	Stop	Stop	Stop	Stop	Stop
RT Channelized	-	-	None	-	-	None	-	-	None	-	-	None
Storage Length	-	-	-	-	-	-	-	-	-	-	-	-
Veh in Median Storage, #	-	0	-	-	0	-	-	0	-	-	0	-
Grade, %	-	0	-	-	0	-	-	0	-	-	0	-
Peak Hour Factor	92	92	92	92	92	92	92	92	92	92	92	92
Heavy Vehicles, %	2	2	2	2	2	2	2	2	2	2	2	2
Mvmt Flow	0	151	34	10	78	2	30	5	24	5	7	14

Major/Minor	Major1			Major2			Minor1			Minor2		
Conflicting Flow All	80	0	0	185	0	0	278	268	168	282	284	79
Stage 1	-	-	-	-	-	-	168	168	-	99	99	-
Stage 2	-	-	-	-	-	-	110	100	-	183	185	-
Critical Hdwy	4.12	-	-	4.12	-	-	7.12	6.52	6.22	7.12	6.52	6.22
Critical Hdwy Stg 1	-	-	-	-	-	-	6.12	5.52	-	6.12	5.52	-
Critical Hdwy Stg 2	-	-	-	-	-	-	6.12	5.52	-	6.12	5.52	-
Follow-up Hdwy	2.218	-	-	2.218	-	-	3.518	4.018	3.318	3.518	4.018	3.318
Pot Cap-1 Maneuver	1518	-	-	1390	-	-	674	638	876	670	625	981
Stage 1	-	-	-	-	-	-	834	759	-	907	813	-
Stage 2	-	-	-	-	-	-	895	812	-	819	747	-
Platoon blocked, %	-	-	-	-	-	-	-	-	-	-	-	-
Mov Cap-1 Maneuver	1518	-	-	1390	-	-	655	633	876	643	620	981
Mov Cap-2 Maneuver	-	-	-	-	-	-	655	633	-	643	620	-
Stage 1	-	-	-	-	-	-	834	759	-	907	806	-
Stage 2	-	-	-	-	-	-	868	806	-	791	747	-

Approach	EB			WB			NB			SB		
HCM Control Delay, s	0			0.8			10.4			9.8		
HCM LOS							B			A		

Minor Lane/Major Mvmt	NBLn1	EBL	EBT	EBR	WBL	WBT	WBR	SBLn1
Capacity (veh/h)	726	1518	-	-	1390	-	-	782
HCM Lane V/C Ratio	0.082	-	-	-	0.007	-	-	0.033
HCM Control Delay (s)	10.4	0	-	-	7.6	0	-	9.8
HCM Lane LOS	B	A	-	-	A	A	-	A
HCM 95th %tile Q(veh)	0.3	0	-	-	0	-	-	0.1

HCM 6th TWSC
4: Research Parkway & Access B

Total Traffic Conditions
Year 2042 - PM Peak Hour

Intersection												
Int Delay, s/veh	0.9											
Movement	EBL	EBT	EBR	WBL	WBT	WBR	NBL	NBT	NBR	SBL	SBT	SBR
Lane Configurations	↘	↑↑↑	↗	↘	↑↑↑	↗			↗			↗
Traffic Vol, veh/h	44	2202	9	11	1181	38	0	0	94	0	0	43
Future Vol, veh/h	44	2202	9	11	1181	38	0	0	94	0	0	43
Conflicting Peds, #/hr	0	0	0	0	0	0	0	0	0	0	0	0
Sign Control	Free	Free	Free	Free	Free	Free	Stop	Stop	Stop	Stop	Stop	Stop
RT Channelized	-	-	None	-	-	None	-	-	None	-	-	None
Storage Length	115	-	-	210	-	240	-	-	0	-	-	0
Veh in Median Storage, #	-	0	-	-	0	-	-	0	-	-	0	-
Grade, %	-	0	-	-	0	-	-	0	-	-	0	-
Peak Hour Factor	92	92	92	92	92	92	92	92	92	92	92	92
Heavy Vehicles, %	2	2	2	2	2	2	2	2	2	2	2	2
Mvmt Flow	48	2393	10	12	1284	41	0	0	102	0	0	47

Major/Minor	Major1			Major2			Minor1			Minor2		
Conflicting Flow All	1325	0	0	2403	0	0	-	-	1197	-	-	642
Stage 1	-	-	-	-	-	-	-	-	-	-	-	-
Stage 2	-	-	-	-	-	-	-	-	-	-	-	-
Critical Hdwy	5.34	-	-	5.34	-	-	-	-	7.14	-	-	7.14
Critical Hdwy Stg 1	-	-	-	-	-	-	-	-	-	-	-	-
Critical Hdwy Stg 2	-	-	-	-	-	-	-	-	-	-	-	-
Follow-up Hdwy	3.12	-	-	3.12	-	-	-	-	3.92	-	-	3.92
Pot Cap-1 Maneuver	272	-	-	*510	-	-	0	0	*406	0	0	357
Stage 1	-	-	-	-	-	-	0	0	-	0	0	-
Stage 2	-	-	-	-	-	-	0	0	-	0	0	-
Platoon blocked, %		-	-	1	-	-			1			
Mov Cap-1 Maneuver	272	-	-	*510	-	-	-	-	*406	-	-	357
Mov Cap-2 Maneuver	-	-	-	-	-	-	-	-	-	-	-	-
Stage 1	-	-	-	-	-	-	-	-	-	-	-	-
Stage 2	-	-	-	-	-	-	-	-	-	-	-	-

Approach	EB			WB			NB			SB		
HCM Control Delay, s	0.4			0.1			16.8			16.6		
HCM LOS							C			C		

Minor Lane/Major Mvmt	NBLn1	EBL	EBT	EBR	WBL	WBT	WBR	SBLn1
Capacity (veh/h)	406	272	-	-	* 510	-	-	357
HCM Lane V/C Ratio	0.252	0.176	-	-	0.023	-	-	0.131
HCM Control Delay (s)	16.8	21	-	-	12.2	-	-	16.6
HCM Lane LOS	C	C	-	-	B	-	-	C
HCM 95th %tile Q(veh)	1	0.6	-	-	0.1	-	-	0.4

Notes
 ~: Volume exceeds capacity \$: Delay exceeds 300s +: Computation Not Defined *: All major volume in platoon